

## Pneumatic Pump Control Module

3A7709D  
EN

User Interface for controlling and monitoring Graco Intelligent Paint Kitchen (IPK) Pneumatic Pumps.  
For professional use only.

19Y486 — Pneumatic Pump Control Module



### Important Safety Instructions

Read all warnings and instructions in this manual, the supplied ADCM manual, and the IPK manuals before using the equipment.  
**Save these instructions.**

*The 19Y486 Pump Control Module uses the 25B475 Advanced Display Control Module (ADCM). See manual 332013 (supplied) for complete warnings and approvals for the 25B475 ADCM.*

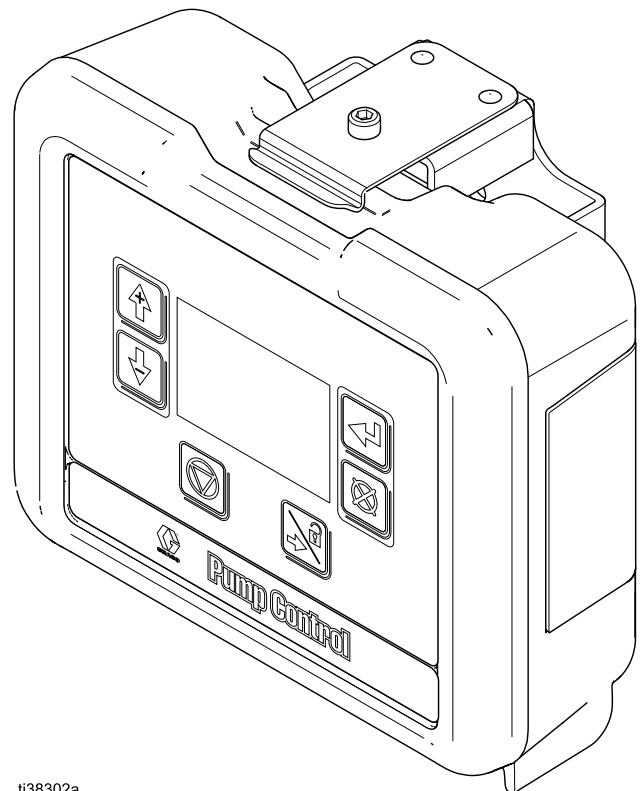

ti38302a

# Contents

Related Manuals .....	2	Pump Setup Chapter.....	29
Approvals.....	2	Diagnostic Chapter .....	30
Warnings .....	3	Totalizer Chapter .....	30
Pump Control Module .....	7	Modbus Chapter .....	31
Installation.....	7	Miscellaneous Chapter .....	32
Hazardous Locations.....	7	Error Code Troubleshooting .....	35
Grounding .....	9	Parts.....	38
Cable Connection .....	11	25B234 Pneumatic ADCM Display	
Typical Installation .....	13	Enclosure Assembly .....	39
Operation.....	14	Accessories and Kits.....	41
Pressure Relief Procedure.....	14	Automatic Air Control Kit 19Y482 and	
Modes of Operation.....	14	20A991 .....	41
Display.....	15	NXT Air Control Kit 19Y996 .....	43
Module Screens.....	16	Transducer I/P Kit 24V001.....	44
Module Menu Bar.....	16	Pressure Transducer Kit for 4-ball Pumps	
Module Keys.....	16	24R050Pressure Transducer Kit	
Run Screens .....	17	for 2-ball Pumps 24Y245.....	44
Pump Control Chapter.....	17	Pressure Transducer Kit for Sanitary	
Totalizer Chapter .....	19	Pumps 24X089.....	45
Agitator Chapter.....	20	California Proposition 65 .....	45
Event Log Chapter .....	21	Appendix A - Modbus Variable Map .....	46
Setup Screens.....	22	Appendix B - Control Module Programming .....	58
Profile Chapter.....	22	Graco Standard Warranty.....	60
Pressure Transducer Chapter .....	27		

# Related Manuals







Manual No.	Description
332013	Advanced Display Control Module (ADCM), Instructions-Parts
332196	IS Power Supply Modules, Instructions-Parts
3A1244	Graco Control Architecture Module Programming, Instructions
3A3382	High-Flo® 4-Ball Pumps, Instructions-Parts
3A3452	4-Ball Lowers with Open Wet Cup, Repair-Parts
333015	Endura-Flo™ 3D150, 3D350, 4D150, and 4D350 Diaphragm Pump, Instructions
307843	Air-Powered Glutton® Pumps, Instructions-Installation
334644	XL™ 10000 Air Motor, Instructions
3A5423	XL™ 6500 and 3400 Air Motors, Instructions

# Approvals



# Warnings

The following warnings are for the setup, use, grounding, maintenance and repair of this equipment. The exclamation point symbol alerts you to a general warning and the hazard symbol refers to procedure-specific risks. When these symbols appear in the body of this manual or on warning labels, refer back to these Warnings. Product-specific hazard symbols and warnings not covered in this section may appear throughout the body of this manual where applicable.

 <h2 style="margin: 0;">WARNING</h2>	
	<p><b>FIRE AND EXPLOSION HAZARD</b></p> <p>Flammable fumes, such as solvent and paint fumes, in <b>work area</b> can ignite or explode. Paint or solvent flowing through the equipment can cause static sparking. To help prevent fire and explosion:</p> <ul style="list-style-type: none"> <li>• Use equipment only in well ventilated area.</li> <li>• Eliminate all ignition sources; such as pilot lights, cigarettes, portable electric lamps, and plastic drop cloths (potential static arc).</li> <li>• Keep work area free of debris, including solvent, rags and gasoline.</li> <li>• Do not plug or unplug power cords, or turn power or light switches on or off when flammable fumes are present.</li> <li>• Ground all equipment in the work area. See <b>Grounding</b> instructions.</li> <li>• Use only grounded hoses.</li> <li>• <b>Stop operation immediately</b> if static sparking occurs or you feel a shock. Do not use equipment until you identify and correct the problem.</li> <li>• Keep a working fire extinguisher in the work area.</li> </ul>
	<ul style="list-style-type: none"> <li>• Use equipment only in well ventilated area.</li> <li>• Eliminate all ignition sources; such as pilot lights, cigarettes, portable electric lamps, and plastic drop cloths (potential static arc).</li> <li>• Keep work area free of debris, including solvent, rags and gasoline.</li> <li>• Do not plug or unplug power cords, or turn power or light switches on or off when flammable fumes are present.</li> <li>• Ground all equipment in the work area. See <b>Grounding</b> instructions.</li> <li>• Use only grounded hoses.</li> <li>• <b>Stop operation immediately</b> if static sparking occurs or you feel a shock. Do not use equipment until you identify and correct the problem.</li> <li>• Keep a working fire extinguisher in the work area.</li> </ul>
	
	<p>Static charge may build up on plastic parts during cleaning and could discharge and ignite flammable vapors. To prevent fire and explosion:</p> <ul style="list-style-type: none"> <li>• Clean plastic parts only in a well-ventilated area.</li> <li>• Do not clean with a dry cloth.</li> </ul>
	



# WARNING



## INTRINSIC SAFETY

Intrinsically safe equipment that is installed improperly or connected to non-intrinsically safe equipment will create a hazardous condition and can cause fire, explosion, or electric shock. Follow local regulations and the following safety requirements.



- Installation should be in accordance with ANSI/ISA RP12.06.01 “Installation of Intrinsically Safe Systems for Hazardous (Classified) Locations” and the National Electrical Code® (ANSI/NFPA 70).



- Installation in Canada should be in accordance with the Canadian Electrical Code, CSA C22.1, Part 1, Appendix F.

- For ATEX, install per EN 60079–14 and applicable local and national codes.

- Equipment that comes in contact with intrinsically safe terminals must meet the entity parameter requirements specified in Control Drawing 16M169. See Appendix A in Manual 332013. This includes safety barriers, DC voltage meters, ohmmeters, cables, and connections. Remove the unit from the hazardous area when servicing.

- Without the safety barrier, the equipment is no longer intrinsically safe and must not be operated in hazardous locations, as defined in article 500 of the National Electrical Code (USA) or your local electrical code.

- Do not install equipment approved only for non-hazardous location in a hazardous area. See the ID label for the intrinsic safety rating for your model.

- Do not use intrinsically safe equipment with a power supply that has no barrier. Intrinsic safety may be compromised.

- Ground the power supply. A voltage limiting safety barrier must be properly grounded to be effective. For proper grounding, use a 12 gauge minimum ground wire. The barrier’s ground must be within 1 ohm of true earth ground.

- Do not remove any cover until power has been removed.

- Do not substitute system components as this may impair intrinsic safety.



# WARNING



## SKIN INJECTION HAZARD

High-pressure fluid from gun, hose leaks, or ruptured components will pierce skin. This may look like just a cut, but it is a serious injury that can result in amputation. **Get immediate surgical treatment.**



- Do not spray without tip guard and trigger guard installed.

- Engage trigger lock when not spraying.

- Do not point gun at anyone or at any part of the body.

- Do not put your hand over the spray tip.

- Do not stop or deflect leaks with your hand, body, glove, or rag.

- Follow the **Pressure Relief Procedure** when you stop spraying and before cleaning, checking, or servicing equipment.

- Tighten all fluid connections before operating the equipment.

- Check hoses and couplings daily. Replace worn or damaged parts immediately.



## EQUIPMENT MISUSE HAZARD

Misuse can cause death or serious injury.

- Do not operate the unit when fatigued or under the influence of drugs or alcohol.

- Do not exceed the maximum working pressure or temperature rating of the lowest rated system component. See **Technical Specifications** in all equipment manuals.

- Use fluids and solvents that are compatible with equipment wetted parts. See **Technical Specifications** in all equipment manuals. Read fluid and solvent manufacturer's warnings. For complete information about your material, request Safety Data Sheets (SDSs) from distributor or retailer.

- Do not leave the work area while equipment is energized or under pressure.

- Turn off all equipment and follow the **Pressure Relief Procedure** when equipment is not in use.

- Check equipment daily. Repair or replace worn or damaged parts immediately with genuine manufacturer's replacement parts only.

- Do not alter or modify equipment. Alterations or modifications may void agency approvals and create safety hazards.

- Make sure all equipment is rated and approved for the environment in which you are using it.

- Use equipment only for its intended purpose. Call your distributor for information.

- Route hoses and cables away from traffic areas, sharp edges, moving parts, and hot surfaces.

- Do not kink or over bend hoses or use hoses to pull equipment.

- Keep children and animals away from work area.

- Comply with all applicable safety regulations.





# WARNING



## PERSONAL PROTECTIVE EQUIPMENT

Wear appropriate protective equipment when in the work area to help prevent serious injury, including eye injury, hearing loss, inhalation of toxic fumes, and burns. Protective equipment includes but is not limited to:

- Protective eyewear, and hearing protection.
- Respirators, protective clothing, and gloves as recommended by the fluid and solvent manufacturer.

# Pump Control Module

The Pump Control Module is a user interface for the setup and control of pneumatic pumps. It is an Advanced Display Control Module (ADCM) that uses specialized software to allow the user to remotely set the mode of pump operation, and to monitor and control pressure and flow rate.



The screen backlight is factory set to remain on, even without screen activity. See [Setup Miscellaneous 1, page 32](#), to set the brightness and backlight timer. Press any key to restore the settings.

Keys are used to input numerical data, enter setup screens, navigate within a screen, scroll through screens, and select setup values.

## Installation

For installation and setup instructions, see the Advanced Display Control Module (ADCM) manual 332013.

### Hazardous Locations

				
<p>Do not substitute or modify system components as this may impair intrinsic safety. For installation, maintenance, or operation instructions, read the instruction manuals provided: 3A7709 and 332013. Do not install equipment approved only for non-hazardous location in a hazardous location. See the identification label for the intrinsic safety rating for your model.</p>				

Intrinsically safe equipment should not be used with a power supply that has no IS barrier. Do not move units from a non-IS installation to an IS installation. IS equipment that has been used with a non-IS power

supply must not be returned to a hazardous location. Always use an IS barrier with IS equipment.

- Install according to Control Drawing Number 16M169. See Appendix A in the Advanced Display Control Module (ADCM) manual 332013.
- Installation in the US should be in accordance with ANSI/ISA RP12.06.01, "Installation of Intrinsically Safe Systems for Hazardous (Classified) Locations," and the National Electrical Code® (ANSI/NFPA 70).
- Installation in Canada should be in accordance with the Canadian Electrical Code, CSA C22.1, Part 1, Appendix F.
- For ATEX, install per EN 60079-14 and applicable local and national codes.
- Multiple earthing of components is allowed only if a high integrity equipotential system is realized between the points of bonding.
- Do not remove any cover until power has been removed.

Installation

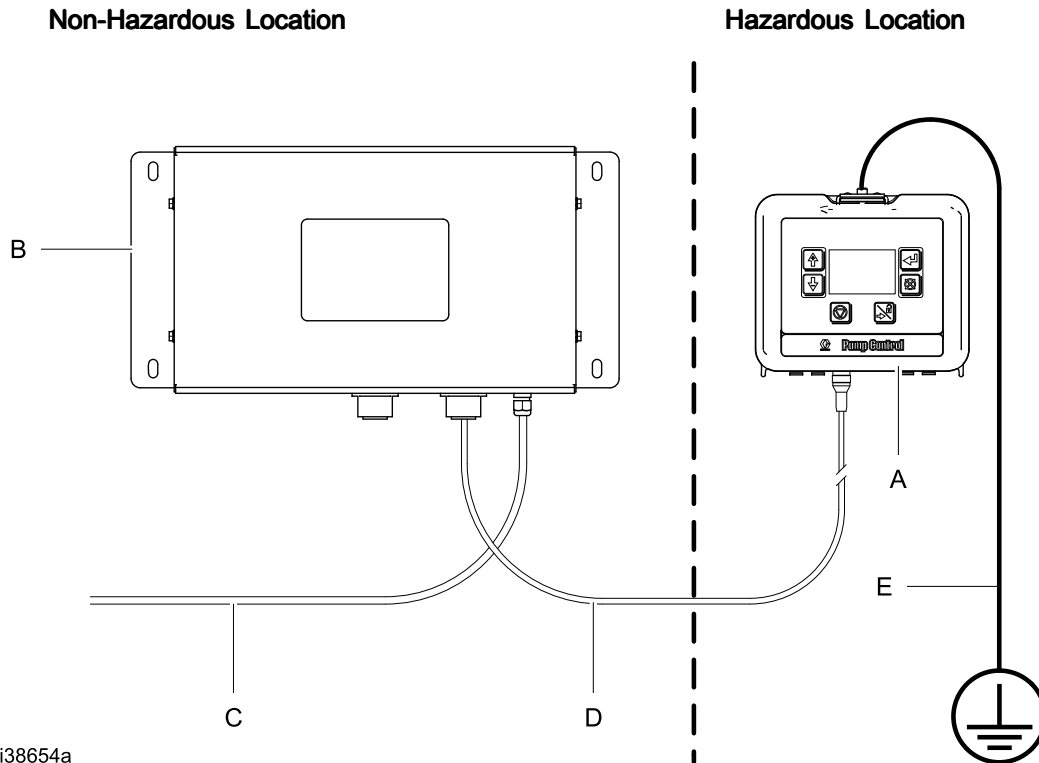

ti38654a





Figure 1 Installation in a Hazardous Location

**KEY:**

- A** Pump Control Module
- B** Power Supply Module
- C** Power Accessory Cable
- D** IS Power Cable (50 ft., 15 m), to terminal 3. See [Cable Connection, page 11](#).
- E** Ground wire and clamp for Pump Control Module. PN 223547 is not supplied.



## Grounding

				
<p>The equipment must be grounded to reduce the risk of static sparking. Static sparking can cause fumes to ignite or explode. Grounding provides an escape wire for the electric current.</p>				

**Pump Control Module:** Grounded through the IS Power Cable (34) to the IS barrier (29) in the Power Supply Module. (See [Power Supply Module Grounding, page 10.](#)) If the mounting bracket is used, connect a ground wire (E) to the screw at the top of the bracket to a true earth ground. (See Figure 1.)

**Power Supply Module:** Follow the grounding instructions in the Power Supply Module manual 332196.

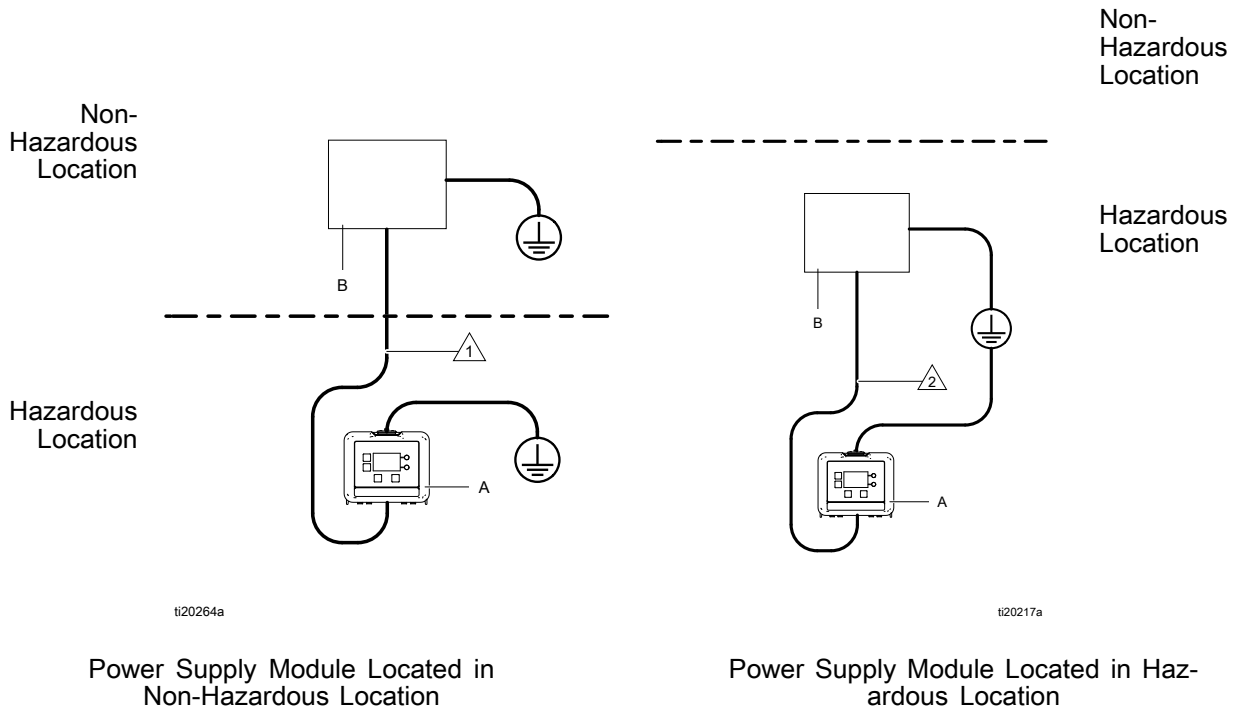

### KEY

**A** Pump Control Module

**B** Power Supply Module and Barrier



The power cable **CANNOT** have the cable shield tied to the coupling nut. 500 VAC isolation is required. The power cable and circuit board are isolated from the Pump Control Module enclosure. They have conductive paths to **SEPARATE** grounds.



The power cable **CAN** have the cable shield tied to the coupling nut. The power cable coupling nut and Pump Control Module have conductive paths to a **COMMON** ground.

## Power Supply Module Grounding

**NOTE:** The callouts and identifications on this page reflect those used in the IS Power Supply Modules manual (332196), and are included here only for reference and for consistency with manual 332196.

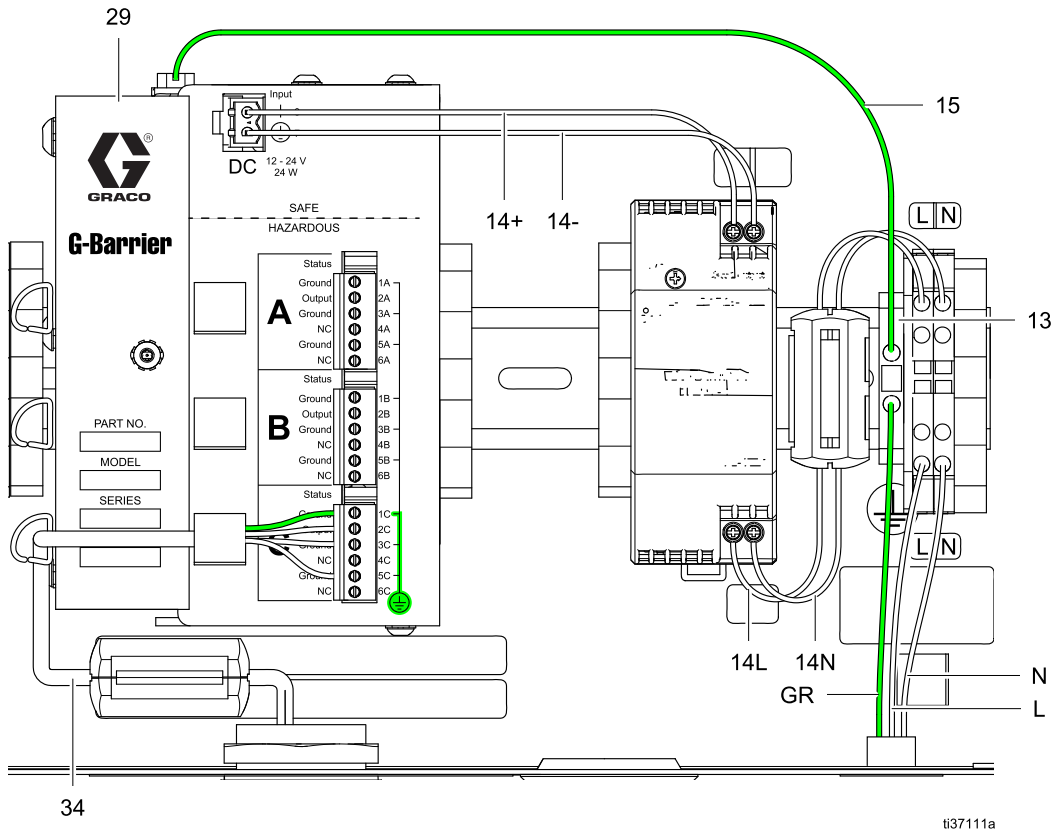

Figure 2 Power Supply Module Grounding

**KEY:**

- GR** Supply Ground Wire
- L** Supply Line Wire
- N** Supply Neutral Wire
- 13** Ground Terminal Block
- 14+** Power Supply output power
- 14-** Power Supply output power
- 14L** Power Supply input power
- 14N** Power Supply input power
- 15** Ground (from the Ground Terminal Block (13) to the G-Barrier (29))
- 29** G-Barrier
- 34** IS Power Cable (from the G-Barrier (29) to the Pump Control Module (A, see Figure 1); installed in factory)

## Cable Connection

Order a power accessory cable (C) from Table 1. Connect the cable to Port 3 on the bottom of the control module (see Figure 3). Connect the other end to the power barrier (see Figure 1). Connect other cables as described in Table 2.

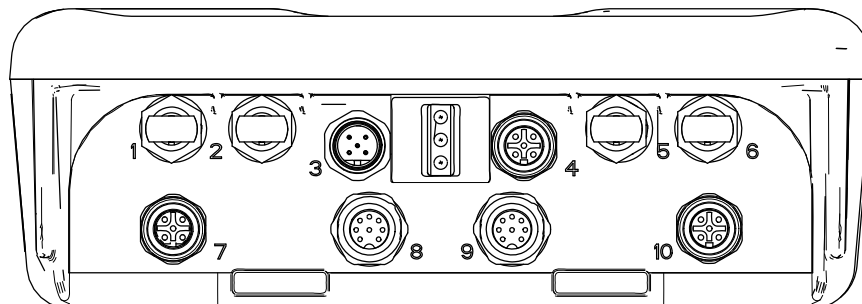

ti19093a

Figure 3 Pump Control Module Connectors

Table 1 Power Accessory Cable

Cable Part No.	Description
16K509	Intrinsically safe power cable, 52 ft (16 m)
16K615	Intrinsically safe power cable, 105 ft (32 m)

Table 2 ADCM Cable Connections

ADCM Port Number	Connector Purpose	Connection	Notes
1	Fiber Optic Receive		Fiber optic receive line used for Modbus communications
2	Fiber Optic Transmit		Fiber optic transmit line used for Modbus communications
3	Power Input	Pin 1 – CAN Low	CAN data low line for GCA communication. CAN communication is not used on this product.
		Pin 2 – Power	Power supply voltage
		Pin 3 – Common	Power supply common
		Pin 4 – CAN High	CAN data high line for GCA communication. CAN communication is not used on this product.
		Pin 5 – Shield	Cable shield

Installation

4	Auxiliary IO	Pin 1 – Voltage	Connected to the system input voltage (Power Input Pin 2)
		Pin 2 – Reed Switch 1 Input	Downstroke input for reed switch. Input can be configured
		Pin 3 – Auxiliary Output	Not used at this time
		Pin 4 – Reed Switch 2 Input	Upstroke input for reed switch. Potential to be configured as input capture, but currently not supported in component library.
		Pin 5 – Common	Connected to the system input voltage common (Power Input Pin 3)
5	Fiber Optic Receive		Mirror of fiber optic receive port 1
6	Fiber Optic Transmit		Mirror of fiber optic transmit port 2
7	Pressure Transducer 1		A differential voltage input. This port can support multiple pressure transducer ranges (see <a href="#">Pressure Transducer Chapter, page 27</a> ). Monitors pump outlet pressure.
8	4–20 mA Output 1		Used to control the air inlet to the pump to regulate the system fluid pressure. The I2P provides a response correlated to the inlet air pressure, with a 0–100% drive signal controlling pressure to a boost value.
9	4–20 mA Output 2		Used to control any back pressure regulator (BPR). At 4 mA (0%) the BPR is completely open, and at 20 mA (100%) the BPR is fully closed.
10	Pressure Transducer 2		A differential voltage input. This port can support multiple pressure transducer ranges. Monitors the pressure at the BPR, but can be used anywhere in the system (including air inlet pressure).

## Typical Installation

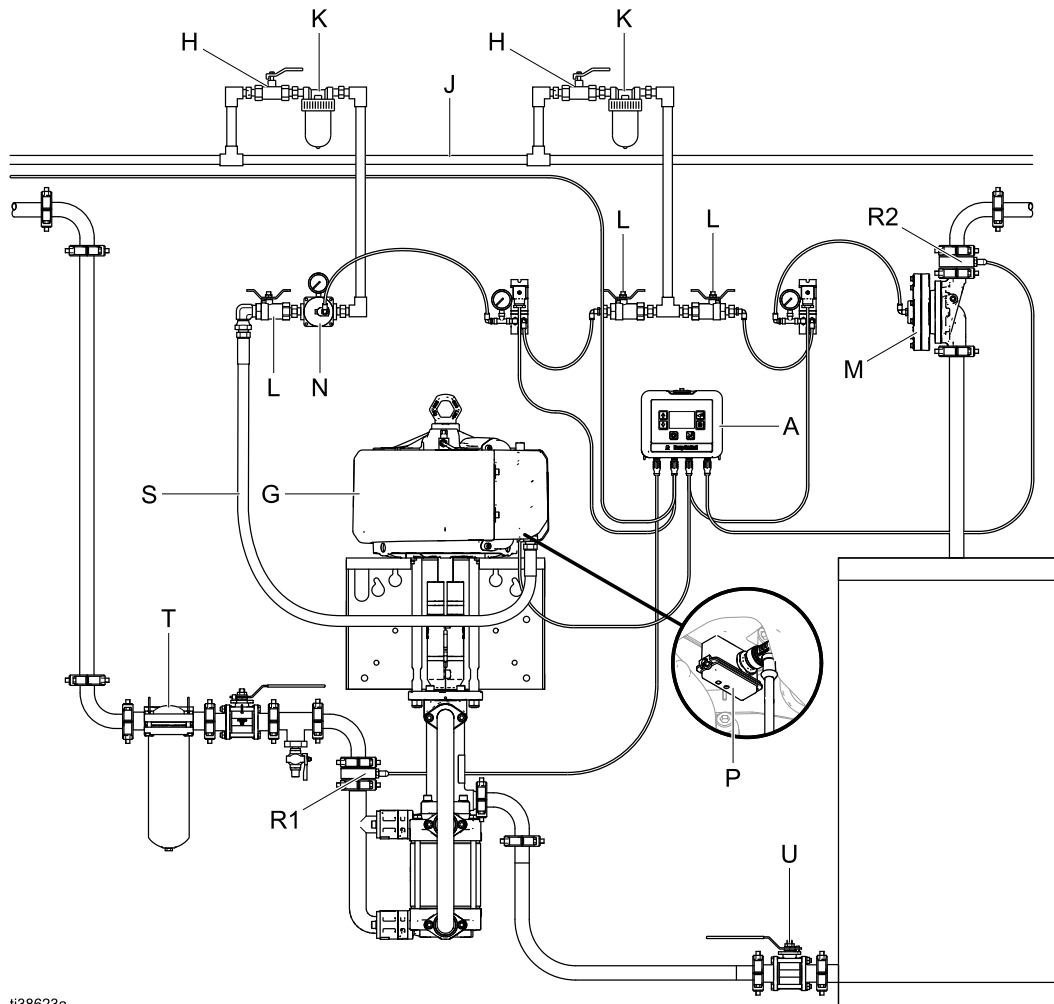

ti38623a

Figure 4 Typical Installation

**KEY:**

- A** Pump control module
- G** Air motor
- H** Air line shutoff valve
- J** Air supply line
- K** Air line filter
- L** Bleed-type master air valve
- M** Back-pressure regulator (BPR)
- N** Self-relieving piloted air regulator
- P** Reed switches
- R1** Pressure transducer at outlet of pump
- R2** Pressure transducer at BPR
- S** Pump inlet hose
- T** Fluid filter
- U** Fluid inlet shutoff valve

# Operation

## Pressure Relief Procedure



Follow the Pressure Relief Procedure whenever you see this symbol.

Unexpected activation of the pump could result in serious injury from pressurized fluid, such as skin injection, splashing fluid and moving parts. Follow the Pressure Relief Procedure when you stop spraying and before cleaning, checking, or servicing the equipment.

1. Ensure the pump is off by pressing the pump shutdown button on the pump control module (A).
2. Close the bleed-type master air valve (L).
3. Open all fluid drain valves in the system, having a waste container ready to catch drainage. Leave drain valves open until you are ready to spray again.

## Modes of Operation

### Pressure Control

When the system is in pressure control mode, the pump controls the pressure provided at the outlet of the pump with closed-loop control. The unit controls the air into the pump using an I2P while monitoring the outlet pressure with a differential pressure sensor. The control loop updates at the top of the cycle. The pressure target should be reached within five cycles.

### Flow Control

When the system is in flow control mode, the pump controls to a flow rate using pressure. Flow rate is estimated on cycles/minute and volume displacement. The control loop updates at the top of the cycle for traditional air motors and at the left cycle of an AODD or Glutton®. The flow rate target should be reached within five cycles.

### Hybrid

When the system is in control pump mode, the pump controls to a pressure target while also updating the BPR setpoint to control the flow rate. The user is required to enter a pressure target, flow rate target, and a maximum flow rate value. The system first achieves the pressure target. Next, if the system is running too fast or slow based on the flow rate target, the system adjusts the BPR target to achieve the flow rate target. If the BPR target is at either 100% or 0%, the flow rate target may not be achieved.







### Open Loop

When the system is in open loop mode, a fixed air pressure is applied to the pump inlet. The system will operate similarly to a manual air regulator. Changing the percentage set point up or down adjusts the air applied to the air motor inlet.

**NOTE:** This mode of operation is only recommended if the other modes cannot be used, but the pump still needs to operate. To troubleshoot error codes see [Error Code Troubleshooting, page 35](#).

## Display

### Overlay

Overlay Keys		
 Up Arrow	<p><b>Page Navigation</b></p> <p>The up arrow is used to move to the previous page. If the user is at Page 1, pressing the up arrow causes the pages to roll over to the last page.</p>	<p><b>Setpoint Incrementation</b></p> <p>When the user is in an entry field, the up arrow is used to increment the value. If the value is at "9", pressing the up arrow will cause the value to roll over to "0".</p>
 Down Arrow	<p><b>Page Navigation</b></p> <p>The down arrow is used to move to the next page. If the user is at the last page, pressing the down arrow causes the pages to overflow and display the first page.</p>	<p><b>Setpoint Decrementation</b></p> <p>When the user is in an entry field, the down arrow is used to decrement the value. If the value is at "0", pressing the down arrow will cause the value to roll over to "9".</p>
 Right Arrow / Setup	<p><b>Chapter Navigation</b></p> <p>The right arrow is used to move to the next chapter. If the user is at the last chapter, pressing the right arrow will wrap around to the first chapter.</p>	<p><b>Setup</b></p> <p>To enter or exit Setup, the user will press and hold the right arrow key for three seconds.</p>
 Enter	<p><b>Field Entry</b></p> <p>Pressing the enter key activates a field for editing, activates the changes in a highlighted field, selects a highlighted option in a menu, and selects or unselects a checkbox.</p>	
 Shutdown	<p><b>Stop Pump</b></p> <p>Pressing the shutdown key will stop the pump.</p>	
 Cancel	<p><b>Field Entry</b></p> <p>When the user is in a menu or a numeric field, pressing the cancel key causes the display to exit field entry mode and revert back to the previous screen.</p>	

## Module Screens

There are two sets of screens (Books): Run and Setup. Run and Setup books contain chapters, and every chapter contains pages. Chapters are accessed by using the right arrow key. At the bottom of the screen there are dots to indicate the number of chapters and to highlight the current chapter. If you navigate past the chapter you want to display, you need to continue pressing right arrow key to wrap back to the chapter you would like to update.

Pages are accessed using the up and down arrows. At the right side of the screen there are dots to indicate the number of pages in this chapter and to highlight the current page.



Press and hold the right arrow / lock icon (  ) for three seconds to enter or exit Setup.

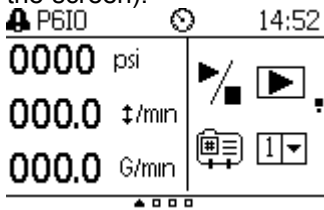

**NOTE:** The screen automatically dims based on the load requirements.

Example: This set of Run Screens has three chapters (indicated by the bottom of the screen) and two pages (indicated by the squares on the right side of the screen).



## Module Menu Bar

The Module Top Menu only displays on [Run Screens, page 17](#) and shows the following:

- **Error Codes**  See [Error Code Troubleshooting, page 35](#).
- **Current Profile Mode**  (Pressure Mode shown). See [Profile Configuration Page, page 22](#).
- **Time**

## Module Keys

The figure below is a view of the control module display and keys. [Overlay, page 15](#), explains the function of the membrane keys on the control module. As you move through the screens, you will notice that most information is communicated using icons rather than words to simplify global communication. The detailed screen descriptions in [Run Screens, page 17](#), and [Setup Screens, page 22](#), explain what each icon represents. The two keys are membrane buttons whose function correlates with the screen content to the immediate left of the button.

### NOTICE

To prevent damage to the buttons, do not press the buttons with sharp objects such as pens, plastic cards, or fingernails.

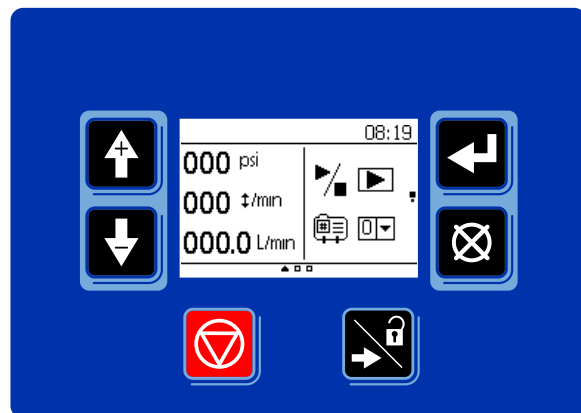

t138303a

Figure 5 Control Module Keypad and Display



# Run Screens

Unexpected activation of the pump could result in serious injury from pressurized fluid, such as skin injection, splashing fluid and moving parts. Follow the Pressure Relief Procedure when you stop spraying and before cleaning, checking, or servicing the equipment.

Run Screens are comprised of the runtime information that the system is monitoring and controlling, such as: Current Flow Rate, Cycle Per Minute, Pressure, Active Profile, etc. See [Overlay, page 15](#), for information on how to make selections and enter data.

## Pump Control Chapter

### Pump Control Page 1

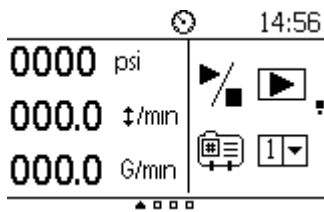

Figure 6 Pump Control Page 1

Pump Control Page 1 Key	
<b>Current Pressure</b>	<p>Displays the current average pressure at the outlet of the pump in pressure units selected in setup.</p> <p>Range:</p> <ul style="list-style-type: none"> <li>• PSI: 0 – 9999</li> <li>• Bar: 0.0 – 999.9</li> <li>• MPa: 0.00 – 99.99</li> </ul>
<b>Cycles Per Minute</b>	<p>Displays the current average cycles rate of the pump in cycles per minute.</p> <p>Range: 00.0 – 99.9 CPM</p>
<b>Current Flow Rate</b>	<p>Display the current flow rate of the pump. Number is calculated based on cycles per minute and displacement. The value is displayed in the flow rate units specified in setup.</p> <p>Range:</p> <ul style="list-style-type: none"> <li>• Gallons/min: 0.0 – 999.9</li> <li>• Liters/min: 0.0 – 999.9</li> <li>• CC/min: 0 – 99999</li> <li>• Oz/min: 0 – 99999</li> <li>• CPM: 0.0 – 99.9</li> </ul>

Pump Control Page 1 Key	
<b>Run/Stop</b>	Command the pump to start or stop, as indicated by a play or pause icon. Press to toggle between the two icons. Range: 0 (■) – 1 (▶) Default: 0 (Pause)
<b>Profile Select</b>	Select the profile ( ) to run on the pump. Profiles are configured in Setup. Range: 1 – 4 Default: Last value the pump was running

### Pump Control Page 2

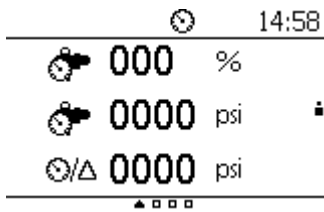

Figure 7 Pump Control Page 2

Pump Control Page 2 Key	
<b>Back Pressure Regulator Percent Output</b>	Displays the current percent output being applied to the back pressure regulator. 0% indicates fully open, while 100% indicates fully closed. Range: 0 – 100%
<b>Back Pressure Regulator Pressure</b>	Displays the average pressure indicated by pressure sensor 2. A common application is the pressure at the Back Pressure Regulator. Range: <ul style="list-style-type: none"> <li>• PSI: 0 – 999</li> <li>• Bar: 0.0 – 99.9</li> <li>• MPa: 0.00 – 9.99</li> </ul>
<b>Delta Pressure</b>	Displays the difference in pressure between the outlet of the pump and the second pressure transducer. Common application is to monitor pressure drop across the circulation line. In that application the second pressure transducer is installed at the BPR. Range: <ul style="list-style-type: none"> <li>• PSI: 0 – 999</li> <li>• Bar: 0.0 – 99.9</li> <li>• MPa: 0.00 – 9.99</li> </ul>

## Totalizer Chapter

### Totalizer Page

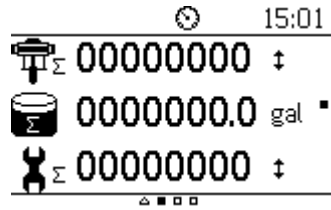



Figure 8 Totalizer Page

Totalizer Page Key	
<p><b>Pump Totalizer</b></p> 	<p>The pump totalizer displays the total cycles/volume that the pump has displaced. This field is not resettable.</p>
<p><b>Batch Totalizer</b></p>	<p>The batch totalizer displays the total volume that the pump has displaced for a particular job. Batch totalizer can be reset in setup.</p>
<p><b>Maintenance Totalizer</b></p> 	<p>The maintenance totalizer displays the current volume that the pump has displaced since the last time maintenance was performed. Maintenance totalizer has to be reset in setup after each maintenance cycle.</p>

**NOTE:** All counters count up.

## Agitator Chapter

This screen displays information for controlling an electric agitator using the supervisor to pass on the control set point to a Variable Frequency Drive (VFD), also known as an inverter.

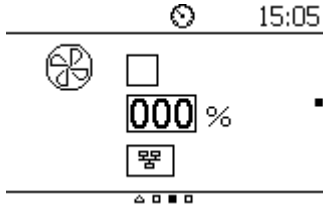



Figure 9 Agitator Chapter

Run Screen 2 Key	
<p><b>Enable/Disable Agitator</b></p> 	Select the box to enable or disable the agitator.
<p><b>Speed Setpoint</b></p>	Set the speed setpoint for the agitator from 0–100%.
<p><b>Local Mode</b></p> 	Select this box to put agitator control in local only mode. Setpoint and Enable/Disable requests from PLC/Supervisor will be ignored.

## Event Log Chapter

The errors screen is utilized to show any system errors that have occurred. The errors will be displayed with one error per row. The previous 20 errors can be displayed at any time over the four error screens. A lack of an error is shown with hyphens '-'. The errors are displayed most recent first.

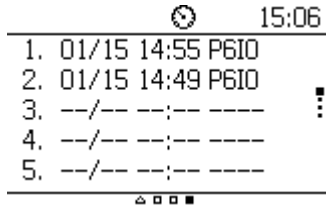

Figure 10 Event Log Chapter

Event Log Key	
<b>Event Log 1</b>	Displays the last 1–5 Events.
<b>Event Log 2</b>	Displays the last 6–10 Events.
<b>Event Log 3</b>	Displays the last 11–15 Events.
<b>Event Log 4</b>	Displays the last 16–20 Events.

# Setup Screens

Use the Setup screens for pump settings and accessory features. See [Overlay, page 15](#), for information on how to make selections and enter data.







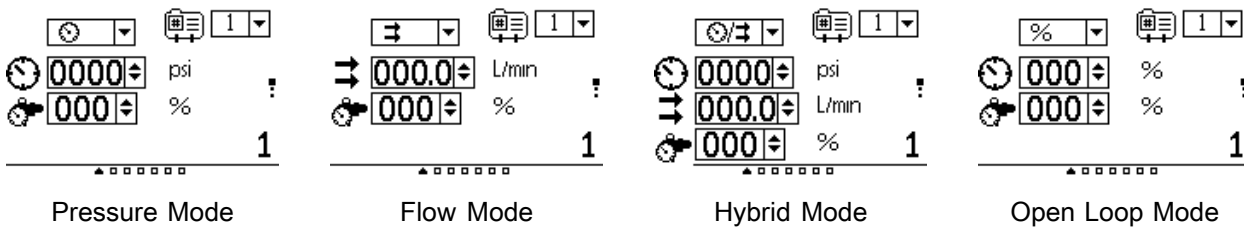



Inactive fields are grayed out on a screen.

## Profile Chapter

### Profile Configuration Page



Profile Configuration Page Key	
<b>Profile Number</b>	Select the number of the desired profiles from the menu: 1 – 4.
<b>Profile Mode</b>	<p>Select the operating mode of the profile.</p> <p>Range:</p> <ul style="list-style-type: none"> <li>• Pressure (🕒) — When selected, the unit will operate on the pressure setpoint with a flow rate limited by the maximum value.</li> <li>• Flow (⇄) — When selected, the unit will operate on the flow setpoint with a pressure limited by the maximum value.</li> <li>• Hybrid (🕒/⇄) — When selected, the unit will operate on the pressure setpoint, and automatically adjust the BPR to control the flow.</li> <li>• Open Loop — When selected the unit will operate on a percentage setpoint from 0 - 100%. This directly correlates to the inlet air to the pump.</li> </ul>
<b>Target</b>	<p>Target fields (see the following Pressure, Flow, and Back Pressure Regulator fields ) are updated based on the Profile Mode.</p> <ul style="list-style-type: none"> <li>• Pressure Mode: <ul style="list-style-type: none"> <li>– Target Pressure (🕒)</li> <li>– BPR Setpoint (🕒)</li> </ul> </li> <li>• Flow Mode: <ul style="list-style-type: none"> <li>– Target Flow (⇄)</li> <li>– BPR Setpoint (🕒)</li> </ul> </li> <li>• Hybrid Mode: <ul style="list-style-type: none"> <li>– Target Pressure (🕒)</li> <li>– Target Flow (⇄)</li> </ul> </li> </ul>

Profile Configuration Page Key	
 <b>Pressure</b>	<p>Sets the target pressure when the Profile Mode field is set to Pressure () or Hybrid () .</p> <p>Range:</p> <ul style="list-style-type: none"> <li>• PSI: 0 – 9999</li> <li>• Bar: 0.0 – 999.9</li> <li>• MPa: 0.00 – 99.99</li> </ul> <p>Default: 0.0</p>
 <b>Flow</b>	<p>Sets the target flow rate when the Profile Mode field is set to Flow () or Hybrid () .</p> <p>Range:</p> <ul style="list-style-type: none"> <li>• Gallons/min: 0.0 – 999.9</li> <li>• Liters/min: 0.0 – 999.9</li> <li>• CC/min: 0 – 99999</li> <li>• Oz/min: 0 – 99999</li> <li>• CPM: 0.0 – 99.9</li> </ul> <p>Default: 0.0</p>
 <b>Back Pressure Regulator (BPR)</b>	<p>Sets the Back Pressure Regulator percentage when Profile Mode field is set to Pressure () or Flow () .</p> <p>To run Hybrid Mode () , enter a starting BPR pressure. This is required to ensure the system is stable. After the Hybrid mode profile starts, the system will automatically adjust the BPR percent based on the starting percentage value. If the system stalls for 15 seconds, then the BPR percentage will automatically decrease.</p> <p>Range:</p> <ul style="list-style-type: none"> <li>• BPR: 0 – 100%</li> </ul> <p>Default: 0</p>

### Limit Configuration Page

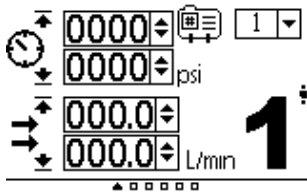

**NOTE:** Limit, Deviation, or Alarm are configured on Profile Page 3 (see [Event Configuration Page, page 26](#)).

Figure 11 Limit Configuration Page

Profile Configuration Page Key	
<b>Pressure High Limit</b>	<p>This field is active when the profile is in Pressure mode, and disabled when in Flow or Hybrid mode.</p> <p><b>NOTE:</b> High Pressure limit should be specified when in Flow mode. If the system stalls, then the system will keep increasing the pressure every 15 seconds to move the pump or until it reaches the specified High Pressure limit.</p> <p>This field can have three different event types:</p> <ul style="list-style-type: none"> <li>• Limit: Limits the maximum pressure the motor can generate.</li> <li>• Deviation: Generates a deviation when the motor pressure exceeds the limit.</li> <li>• Alarm: Generates an alarm and shuts down the motor after the limit is exceeded for two cycles.</li> </ul> <p>– Range:</p> <ul style="list-style-type: none"> <li>◆ PSI: 0 – 9999</li> <li>◆ Bar: 0.0 – 999.9</li> <li>◆ MPa: 0.00 – 99.99</li> </ul> <p>– Default: 0.0</p>
<b>Pressure Low Limit</b>	<p>This field can have three different event types:</p> <ul style="list-style-type: none"> <li>• Limit: Limits the minimum pressure the motor can generate.</li> <li>• Deviation: Generates a deviation when the motor pressure drops below the limit.</li> <li>• Alarm: Generates an alarm and shuts down the motor when the force drops below the limit for two cycles.</li> </ul> <p>– Range:</p> <ul style="list-style-type: none"> <li>◆ PSI: 0 – 9999</li> <li>◆ Bar: 0.0 – 999.9</li> <li>◆ MPa: 0.00 – 99.99</li> </ul> <p>– Default: 0.0</p>



<b>Profile Configuration Page Key</b>	
<b>Flow Rate High Limit</b>	<p>This field is active when the profile is in Flow mode, and is disabled when in Pressure or Hybrid mode.</p> <p>This field can have three different event types:</p> <ul style="list-style-type: none"> <li>• Limit: Limits the maximum flow rate the system can generate.</li> <li>• Deviation: Generates a deviation when the system flow rate exceeds the limit.</li> <li>• Alarm: Generates an alarm and shuts down the motor when the limit is exceeded for two cycles.</li> </ul> <p>– Range:</p> <ul style="list-style-type: none"> <li>◆ Gallons/min: 0.0 – 999.9</li> <li>◆ Liters/min: 0.0 – 999.9</li> <li>◆ CC/min: 0 – 99999</li> <li>◆ Oz/min: 0 – 99999</li> <li>◆ CPM: 0.0 – 999.9</li> </ul> <p>– Default: 0.0</p>
<b>Flow Rate Low Limit</b>	<p>This field can have three different event types:</p> <ul style="list-style-type: none"> <li>• Limit: Limits the minimum flow rate the system can generate.</li> <li>• Deviation: Generates a deviation when the system flow rate drops below the limit.</li> <li>• Alarm: Generates an alarm and shuts down the motor when the flow rate drops below limit for two cycles.</li> </ul> <p>– Range:</p> <ul style="list-style-type: none"> <li>◆ Gallons/min: 0.0 – 999.9</li> <li>◆ Liters/min: 0.0 – 999.9</li> <li>◆ CC/min: 0 – 99999</li> <li>◆ Oz/min: 0 – 99999</li> <li>◆ CPM: 0.0 – 999.9</li> </ul> <p>– Default: 0.0</p>

## Event Configuration Page

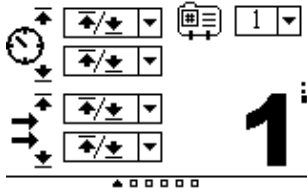

Figure 12 Event Configuration Page

Profile Configuration Page Key	
<b>Pressure/Force High Event Type</b>	<p>Limit: Limits the maximum pressure or force the motor can generate.</p> <p>Deviation: Generates a deviation when the motor pressure exceeds the limit.</p> <p>Alarm: Generates an alarm and shuts down the motor when the limit is exceeded.</p> <ul style="list-style-type: none"> <li>• Range: Limit, Deviation, Alarm</li> <li>• Default: Limit</li> </ul>
<b>Pressure/Force Low Event Type</b>	<p>Limit: Limits the minimum pressure or force the motor can generate.</p> <p>Deviation: Generates a deviation when the motor pressure drops below the limit.</p> <p>Alarm: Generates an alarm and shuts down the motor when the force drops below the limit.</p> <ul style="list-style-type: none"> <li>• Range: Limit, Deviation, Alarm</li> <li>• Default: Limit</li> </ul>
<b>Flow High Event Type</b>	<p>Limit: Limits the maximum flow rate the system can generate.</p> <p>Deviation: Generates a deviation when the system flow rate exceeds the limit.</p> <p>Alarm: Generates an alarm and shuts down the motor when the limit is exceeded.</p> <ul style="list-style-type: none"> <li>• Range: Limit, Deviation, Alarm</li> <li>• Default: Limit</li> </ul>
<b>Flow Low Event Type</b>	<p>Limit: Limits the minimum flow rate the system can generate.</p> <p>Deviation: Generates a deviation when the system flow rate drops below the limit.</p> <p>Alarm: Generates an alarm and shuts down the motor when the flow rate drops below the limit.</p> <ul style="list-style-type: none"> <li>• Range: Limit, Deviation, Alarm</li> <li>• Default: Limit</li> </ul>

## Pressure Transducer Chapter

### Setup Pressure Sensor 1

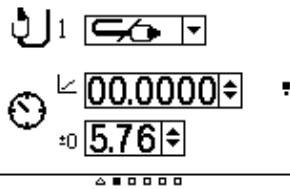





Figure 13 Setup Pressure Sensor 1

Setup Pressure Sensor 1 Key	
<p><b>Pressure Transducer</b></p> 	<p>Use the menu to select the attached transducer option. The default value is the no transducer icon ().</p> <p>Range: No transducer, 500 psi, or 7500 psi.</p> <p>Default: 500 psi</p>
<p><b>Sensor Sensitivity</b></p> 	<p>Enter the calibration scale factor into this field. Each pressure transducer has a unique calibration scale factor.</p> <p>Range: 00.0000 – 99.9999 mV/V</p> <p>Default: 00.0000 mV/V</p>
<p><b>Offset Voltage</b></p> <p>±0</p>	<p>Enter the offset factor into this field. Each pressure transducer has a unique offset voltage factor.</p> <p>Range: 0.00 – 9.99 mV/V</p> <p>Default: 0.00 mV/V</p>

## Setup Pressure Sensor 2

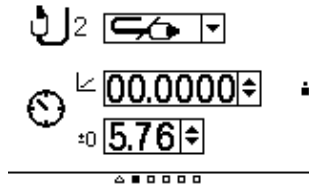

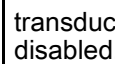

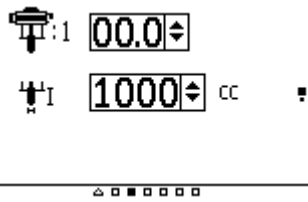



Figure 14 Setup Pressure Sensor 2

Setup Pressure Sensor 2 Key	
<p><b>Pressure Transducer</b></p> 	<p>Use the menu to select the attached transducer option. The default value is the no transducer icon (). When 100 psi is selected, the delta pressure feature is disabled. It is assumed that the air inlet to the pump is monitored.</p> <p>Range: No transducer, 500 psi, or 7500 psi.</p> <p>Default: No transducer</p>
<p><b>Sensor Sensitivity</b></p> 	<p>Enter the calibration scale factor into this field. Each pressure transducer has a unique calibration scale factor.</p> <p>Range: 00.0000 – 99.9999 mV/V</p> <p>Default: 00.0000 mV/V</p>
<p><b>Offset Voltage</b></p> <p>±0</p>	<p>Enter the offset factor into this field. Each pressure transducer has a unique offset voltage factor.</p> <p>Range: 0.00 – 9.99 mV/V</p> <p>Default: 0.00 mV/V</p>

## Pump Setup Chapter



### Pump Setup Screen 1

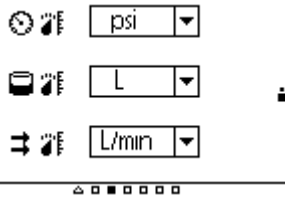

Pump Setup Screen 1 Key	
<p><b>Pump Ratio</b></p> 	Enter the pump ratio. Reference the product manual if the value is not known.
<p><b>Lower Size</b></p> 	Check the box to lock out the agitator field in the Run screens.

### Pump Setup Screen 2



Pump Setup Key	
<p><b>Pressure Units</b></p> 	<p>Select the pressure units:</p> <ul style="list-style-type: none"> <li>• psi</li> <li>• bar (default)</li> <li>• MPa</li> </ul>
<p><b>Volume Units</b></p> 	<p>Select the volume units:</p> <ul style="list-style-type: none"> <li>• liters (default)</li> <li>• gallons</li> <li>• cc</li> </ul>
<p><b>Flow Rate Units</b></p> 	<p>Select the flow rate units:</p> <ul style="list-style-type: none"> <li>• L/min (default)</li> <li>• gpm</li> <li>• cc/min</li> <li>• oz/min</li> <li>• cycles/min</li> </ul>

## Diagnostic Chapter

### Setup Diagnostic

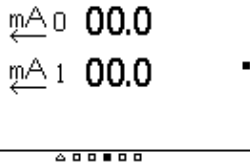

Figure 15 Setup Diagnostic

Setup Diagnostic Outputs Key	
<b>Current Readback</b> — Port 8	This non-editable field reads the instantaneous output current in mA for motor inlet I2P output.
<b>Current Readback</b> — Port 9	This non-editable field reads the instantaneous output current in mA for Back Pressure Regulator I2P output.

## Totalizer Chapter

### Setup Totalizer

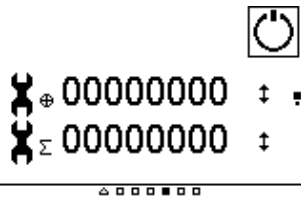



Figure 16 Setup Totalizer

Set Totalizer Key	
<b>Maintenance Cycles</b> 	Counts down the number of cycles before a maintenance event is triggered. A maintenance event is triggered when the value hits zero. This field is resettable.  Range: 0 – 9999999 cycles Default: 0
<b>Maintenance Setpoint</b> 	Sets the amount of cycles in a maintenance cycle.  Range: 0 – 9999999 cycles Default: 0

## Modbus Chapter

Use this screen to set the Modbus preferences.

**NOTE:** The following are fixed Modbus settings, which cannot be set or changed by the user:





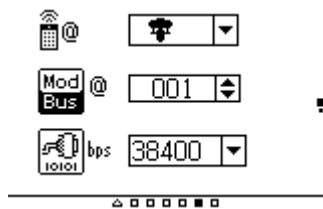

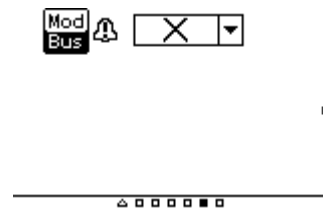

Data Bits: 8  
 Stop Bits: 2  
 Parity: None

**Modbus Setup: Screen 1**



**Modbus Setup: Screen 2**



Modbus Setup Key	
<p><b>Location</b></p> 	<p>Select local  or remote  from the menu. This setting applies to the selected pump only.</p> <p>Local mode allows you to view changes over the Modbus network, but you cannot make changes over the Modbus network. Remote mode allows you to both view and change information over the Modbus network.</p>
<p><b>Modbus Node ID</b></p> 	<p>Enter or change the Modbus node ID. The value is between 1 and 246. Each pump requires a unique node ID, which identifies that pump if more than one pump is connected to the display.</p>
<p><b>Serial Port Baud Rate</b></p> 	<p>Select the serial port baud rate from the menu. This is a system-wide setting.</p> <ul style="list-style-type: none"> <li>• 38400 kbps</li> <li>• 57600 kbps (default)</li> <li>• 115200 kbps</li> </ul>
<p><b>Modbus Event</b></p> 	<p>Select the Modbus event type:</p> <ul style="list-style-type: none"> <li> None</li> <li> Deviation</li> <li> Alarm</li> </ul>

## Miscellaneous Chapter

### Setup Miscellaneous 1

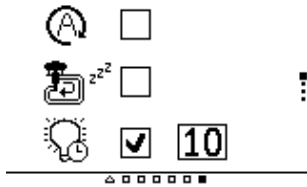





Figure 17 Setup Miscellaneous 1

<b>Setup Maintenance 1 Key</b>	
<b>Auto Restart</b> 	When enabled if the pump losses power it will automatically resume operation in the last profile it was running before power loss. Range: 0 – 1 Default: 0
<b>Off Production Mode</b> 	Enable the off production profile mode. This feature turns profile 4 into the off production profile.
<b>Backlight Time-out</b> 	Specify the back light timeout in minutes. If the display is inactive for x amount of time the display backlight will turn off. If value is 0 then backlight will always remain on. Range: 0 – 99 Default: 10



## Setup Miscellaneous 2

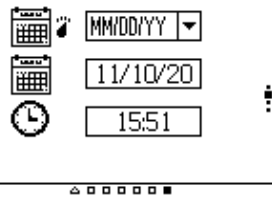





Figure 18 Setup Miscellaneous 2

Setup Maintenance 2 Key	
<p><b>Date Order</b></p> 	<p>Use the drop down menu to select the desired date orientation.                      Range: MM/DD/YY, DD/MM/YY, or YY/MM/DD                      Default: MM/DD/YY</p>
<p><b>Set Date</b></p> 	<p>Use the field to set the current date.                      Month Range: 01-12                      Day Range: 01-31                      Year Range: 00 -99</p>
<p><b>Set Time</b></p> 	<p>Use the field to set the current time.                      Hour Range: 01-23                      Minute Range: 01-59</p>

### Setup Miscellaneous 3

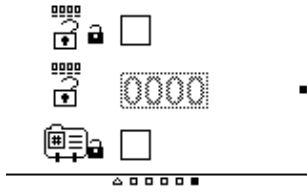









Figure 19 Setup Miscellaneous 3

<b>Setup Maintenance 3 Key</b>	
<p><b>Passcode</b></p> 	<p>Enables passcode entry when user enters setup.</p> <p>Range: Enable / Disable</p> <p>Default: Disable</p>
<p><b>Passcode Enable</b></p> 	<p>Check the box next to the lock icon to enable a passcode on the device. Enter the desired passcode in the field below the box. Upon accepting these changes, pressing the lock softkey will lock the access to the settings of the device. A password of 0000 is invalid and will not lock the settings of the device.</p> <p>Range: 0000 – 9999</p> <p>Default: 0000</p>
<p><b>Profile Lock</b></p> 	<p>Check the box next to profile lock icon () to lock out the user from modifying the current profile on the Run screens.</p> <p>Range: Enable / Disable</p> <p>Default: Disable</p>

# Error Code Troubleshooting

Error codes can take three forms:

- Alarm  : alerts you to the alarm cause and shuts down the pump.
- Deviation  : alerts you to the problem, but pump may continue to run past the set limits until the system's absolute limits are reached.
- Advisory  : information only. Pump will continue to operate.

**NOTE:** On Advanced motors, flow (K codes) and pressure (P codes) can be designated as alarms or deviations. See [Event Configuration Page, page 26](#).

**NOTE:** In the error codes listed below, an “X” means the code is associated with the display only.

**NOTE:** In the error codes listed below, a “\_” in the code is a placeholder for the number of the pump where the event occurred.

**NOTE:** The blink code is displayed using the power indicator on the motor. The blink code given below indicates the sequence. For example, blink code 1–2 indicates 1 blink, then 2 blinks; the sequence then repeats.

**NOTE:** A blink code of 9 is not an error code, but an indicator of which pump is active.

Event Code	Event	Event Type	Description
<b>C3G1</b>	Modbus Communication Deviation	Deviation	Display detects a loss of Modbus communication when Modbus event type is setup to be a deviation. Trigger event if there has not been a Modbus read event within 1 second.
<b>C4G1</b>	Modbus Communication Alarm	Alarm	Display detects a loss of Modbus communication when Modbus event type is setup to be an alarm. Trigger event if there has not been a Modbus read event within 1 second.
<b>DD90</b>	Reed Switch Failure	Deviation	System is not detecting a reed switch.
<b>DK61</b>	Pump Diving Down Stroke	Deviation	The time to complete a down stroke is significantly shorter to complete than an up stroke.
<b>DK62</b>	Pump Cavitation Up Stroke	Deviation	The time to complete an up stroke is significantly shorter than to complete a down stroke.
<b>K1D1</b>	Minimum Flow Rate Alarm	Alarm	Average flow rate has dropped below minimum flow rate threshold specified for active profile. Event will trigger if minimum flow rate event is configured for alarm.
<b>K2D1</b>	Minimum Flow Rate Deviation	Deviation	Average flow rate has dropped below minimum flow rate threshold specified for active profile. Event will trigger if minimum flow rate event is configured for deviation.

Error Code Troubleshooting

Event Code	Event	Event Type	Description
<b>K3D1</b>	Maximum Flow Rate Deviation	Deviation	Average flow rate has risen above maximum flow rate threshold specified for active profile. Event will trigger if maximum flow rate event is configured for deviation.
<b>K4D1</b>	Maximum Flow Rate Alarm	Alarm	Average flow rate has risen above maximum flow rate threshold specified for active profile. Event will trigger if maximum flow rate event is configured for alarm.
<b>P1I1</b>	Minimum Pressure 1 Alarm	Alarm	Average pump outlet pressure has dropped below minimum pressure threshold specified for active profile. Event will trigger if minimum pressure event is configured for alarm.
<b>P2I1</b>	Minimum Pressure 1 Deviation	Deviation	Average pump outlet pressure has dropped below minimum pressure threshold specified for active profile. Event will trigger if minimum pressure event is configured for deviation.
<b>P3I1</b>	Maximum Pressure 1 Deviation	Deviation	Average pump outlet pressure has risen above maximum pressure threshold specified for active profile. Event will trigger if maximum pressure event is configured for deviation.
<b>P4I1</b>	Maximum Pressure 1 Alarm	Alarm	Average pump outlet pressure has risen above maximum pressure threshold specified for active profile. Event will trigger if maximum pressure event is configured for alarm.
<b>P6I1</b>	Pressure Transducer 1 Fault	Alarm	For units without closed loop pressure control: Transducer 1 is enabled but not detected.
<b>P1CB</b>	Minimum Pressure 2 Alarm	Alarm	Average pressure at transducer 2 has dropped below minimum pressure threshold. Event will trigger if minimum pressure event is configured for alarm.
<b>P2CB</b>	Minimum Pressure 2 Deviation	Alarm	Average pressure at transducer 2 has dropped below minimum pressure threshold. Event will trigger if minimum pressure event is configured for deviation.

<b>Event Code</b>	<b>Event</b>	<b>Event Type</b>	<b>Description</b>
<b>P3CB</b>	Maximum Pressure 2 Deviation	Alarm	Average pressure at transducer 2 has risen above maximum pressure threshold. Event will trigger if maximum pressure event is configured for deviation.
<b>P4CB</b>	Maximum Pressure 2 Alarm	Alarm	Average pressure at transducer 2 has risen above maximum pressure threshold. Event will trigger if maximum pressure event is configured for alarm.
<b>P6CB</b>	Pressure Transducer 2 Fault	Alarm	Transducer 2 is open circuit.
<b>P6D1</b>	Motor Inlet I2P is disconnected	Alarm	Port 8 is enabled and the current draw is less than 4 mA. The motor air inlet driver is requesting a value greater than 0%. Verify that the device is connected.
<b>P6P1</b>	Back Pressure Regulator I2P is disconnected	Alarm	Port 9 is enabled and the current draw is less than 4 mA. The BPR is requesting a value greater than 0%. Verify the device is connected.
<b>WSC1</b>	Pressure Target is 0	Alarm	Profile is set to 0 pressure.
<b>WSC2</b>	Flow Rate Target is 0	Alarm	Profile is set to 0 flow.
<b>WSD1</b>	Invalid Lower Size	Alarm	Invalid lower size; occurs if the unit is operated before setting up the lower size.
<b>WSD2</b>	Invalid Pump Ratio	Alarm	Invalid pump ratio; occurs if the unit is operated before setting up the pump ratio.

# Parts

## 19Y486 Pump Control Module

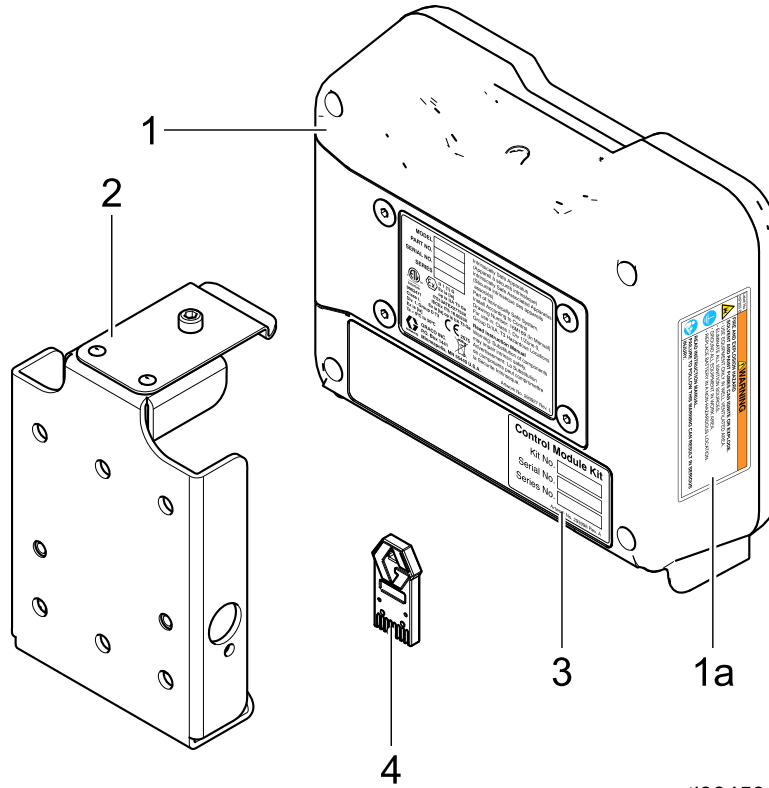

ti38453a

Ref	Part	Description	Qty	Ref	Part	Description	Qty
1	19Y486	DISPLAY KIT, control module; includes item 1a, 1b, and 1c; see manual 332013 for approvals information about the bare ADCM module	1	2	---	BRACKET, control module	1
1a▲	16P265	LABEL, warning, English	1	3	---	LABEL, product	1
1b▲	16P265	LABEL, warning, French	1	4	---	TOKEN, GCA, upgrade, IPK pneumatic	1
1c▲	16P265	LABEL, warning, Spanish (shipped loose)	1				

▲ Replacement safety labels, tags, and cards are available at no cost.

Items marked --- are not available separately.

# 25B234 Pneumatic ADCM Display Enclosure Assembly

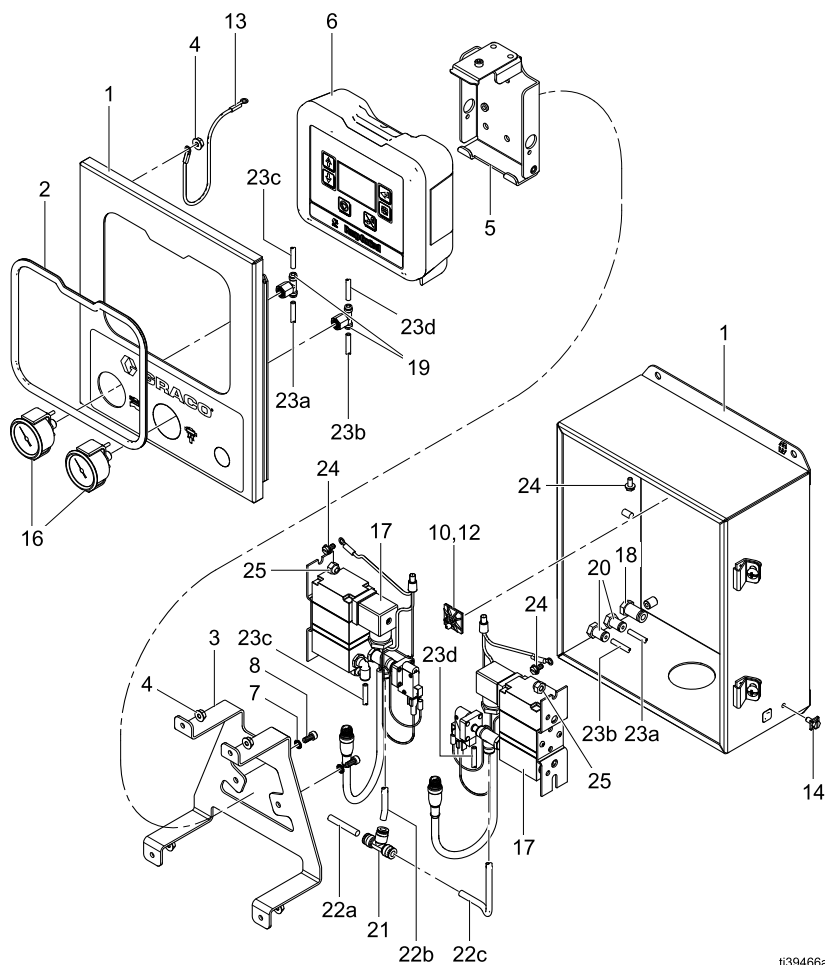
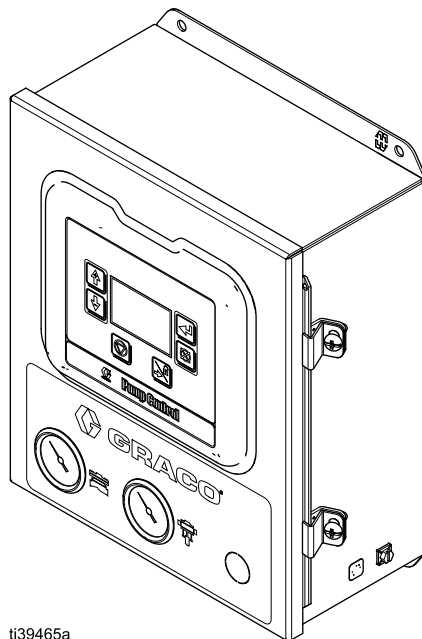

Parts

Ref	Part	Description	Qty	Ref	Part	Description	Qty
1	— — —	ENCLOSURE, ADCM	1	14	— — —	SCREW ,GROUND	1
2	114225	TRIM, EDGE PROTECTION	1	16	15T500	GAUGE, PRESSURE, AIR, PL MNT, 1/8	2
3	— — —	BRACKET, MOUNTING, AOCM, PAINTED	1	17		TRANSDUCER, I/P, PRESSURE SWITCH	2
4	— — —	NUT, FLANGE, SERRATED, #10-32, SS	5	18	104176	BULKHEAD, 1/4 T X 1/4 T	1
5	277853	BRACKET, MOUNTING, BOOTH CONTROL	1	19	— — —	FITTING, TEE, 5/32 TUBE, 1/8 NPT	2
6	258475	MODULE, GCA, ADCM, IS	1	20	— — —	BULKHEAD, TUBE, 5/32	2
7	— — —	WASHER, LOCK, EXTERNAL	2	21	U5415	FITTING, UNION, TEE 1/4 TUBE	1
8	117026	SCREW, SHCS M5XU	2	22	— — —	TUBE, POLYURETHANE, RD	1
10	— — —	HOLDER, TIE	1	23	54757	TUBE, NYLON, RND	1
12	102478	U STRAP, TIE WIRING	1	24	— — —	SCREW, GROUND, 10-32	3
13	— — —	WIRE, GROUNDING PANEL	1	25	— — —	NUT, LOCK, HEX	4

Items marked — — — are not available separately.



# Accessories and Kits

## Automatic Air Control Kit 19Y482 and 20A991

The air regulator (106) is used to control air into the Air Motor (G, see [Typical Installation, page 13](#)). The reed switch assembly (102) monitors pump operation and provides control to the transducer I2P (101). The reed switch cable (105) connects the reed switch assembly (102) to the 19Y486 Pump Control Module (A).

Ref	Part	Description	Qty
102	24X220	SWITCH, reed, assembly (19Y482)	1
	273274	SWITCH, reed, assembly (20A991)	
103	— — —	SCREW, pan head, #8-32 X 1.5 in.	1
104	102360	WASHER, flat	1
105	19Y480	CABLE, M12 harness connect	1
106	19Y479	REGULATOR, remote piloted, 3/4 in.	1

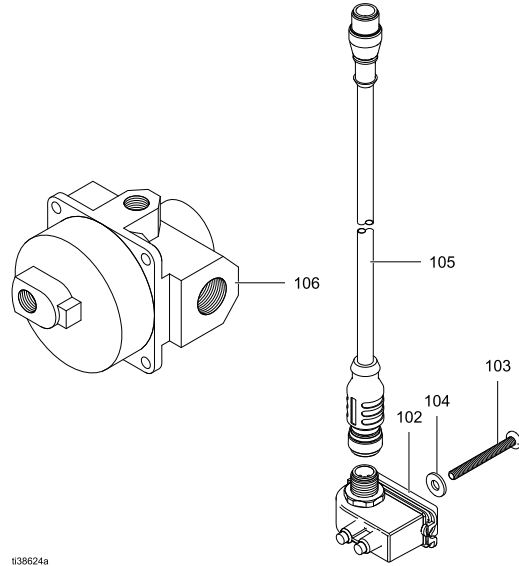

### 20A991 Requirements

Use 20A991 with XL Air Motors with Series B or later air valves. See the air valve label  to determine the air valve series.

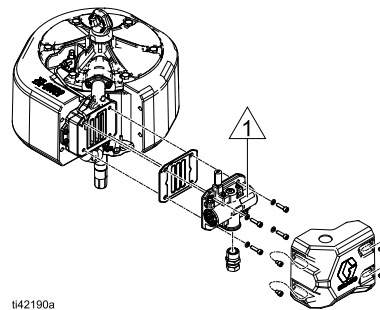

label location

Figure 20 Air valve

**Technical Specifications for 19Y482 and 20A991**

Reed Switch 24X220 and 273274	US	Metric
<b>Electrical Ratings:</b>		
Voltage	24 VDC	
Current	400 mA	
Power	10 W maximum	
Ambient Temperature	-22°F – 158°F	-30°C – 70°C
<b>EX Ratings:</b>		
Classification	<p>"Simple Apparatus" in accordance with UL/EN/IEC 60079-11, clause 5.7                      Class I, Div 1: Group D T4</p> <p style="text-align: center;">                       Ex ia IIC T4 Ga                 </p>	
Parameters	<p> <math>U_i = 17.9 \text{ V}</math>  <math>I_i = 400 \text{ mA}</math>  <math>P_i = 1.2 \text{ W}</math>  <math>C_i = 1.2 \text{ nF}</math>  <math>L_i = 6.0 \text{ }\mu\text{H}</math>  <math>L_i/R_i = 5.9 \text{ }\mu\text{H}/\Omega</math> </p>	

## NXT Air Control Kit 19Y996

The air regulator (206) is used to control air into the Air Motor (G, see [Typical Installation, page 13](#)). The NXT reed switch assembly (203) monitors pump operation and provides control to the transducer I2P (201). The reed switch cable (205) connects the NXT reed switch assembly (203) to the 19Y486 Pump Control Module (A). The NXT reed switch conversion cable (202) allows the M12 reed switch cable (205) to connect to connect to the standard NXT air motor reed switch (203).

Ref	Part	Description	Qty
202	19Y997	SWITCH, reed, NXT, assembly	1
203	119700	SENSOR, reed switch	1
204	102730	SCREW, machine, hex washer head	1
205	19Y480	SWITCH, M12 harness connect	1
206	19Y479	REGULATOR, remote piloted, 3/4 in.	1
207	118605	O-RING	1

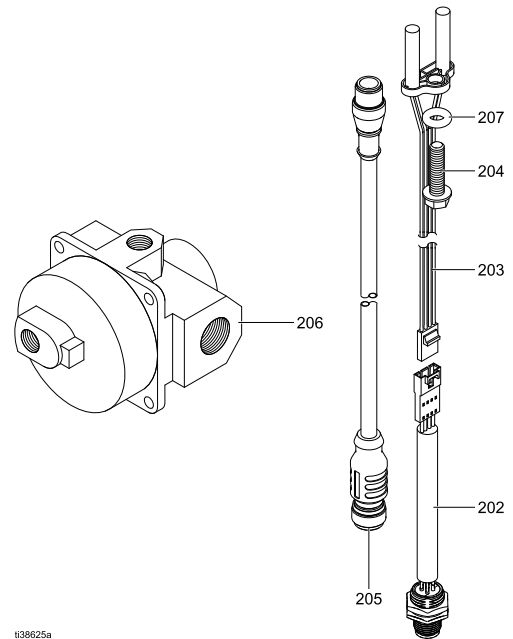

## Technical Specifications for 19Y996

Reed Switch 119700	US	Metric
<b>Electrical Ratings:</b>		
Voltage	24 VDC	
Current	500 mA	
Power	10 W maximum	
Ambient Temperature	-40°F – 221°F	-40°C – 105°C
<b>EX Ratings:</b>		
Classification	"Simple Apparatus" in accordance with UL/EN/IEC 60079-11, clause 5.7 Class I, Div 1: Group D T4 	
Parameters	U <sub>i</sub> = 17.9 V I <sub>i</sub> = 500 mA P <sub>i</sub> = 1.2 W C <sub>i</sub> = 1.2 nF L <sub>i</sub> = 6.0 μH L <sub>i</sub> /R <sub>i</sub> = 5.65 μH/Ω	

### Transducer I/P Kit 24V001

Used for Air Motor air inlet control and Back Pressure Regulator control. For the Air Motor (G, see [Typical Installation, page 13](#)), the cable (302) connects to Port 8 on the 19Y486 Pump Control Module (A). For the Back Pressure Regulator (M), the cable (302) connects to Port 9 on the 19Y486 Pump Control Module (A).

Ref	Part	Description	Qty
301	---	TRANSDUCER, miniature	1
302	---	CABLE, F/C, I.S., 8 M	1
303	110436	GAUGE, pressure, air	1
304	100030	BUSHING	1
305	198178	ELBOW	1
306	110207	ELBOW	1
307	C19466	TEE	1
308	198171	ELBOW	1

--- Parts not sold separately.

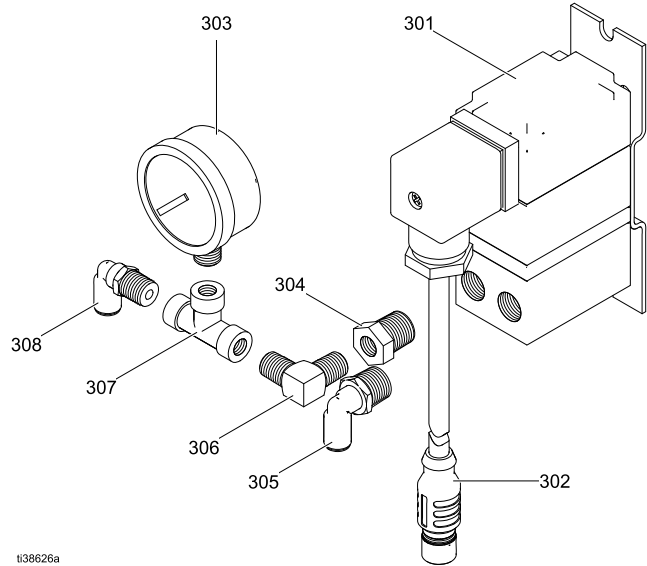

### Pressure Transducer Kit for 4-ball Pumps 24R050 Pressure Transducer Kit for 2-ball Pumps 24Y245

Pressure transducer kits are used to monitor the pump outlet pressure (R1, see [Typical Installation, page 13](#)) and pressure at the Back Pressure Regulator (R2, M). For monitoring pump outlet pressure (R1), the cable (403) connects to Port 7 on the 19Y486 Pump Control Module (A). For the pressure transducer (R2) at the Back Pressure Regulator (M), the cable (403) connects to Port 10 on the 19Y486 Pump Control Module (A).

Ref	Description	24R050 Part	24Y245 Part	Qty
401	ADAPTER, fitting, pressure sensor	16U440		1
402	PACKING, o-ring	119348		1
403	SENSOR, pressure, fluid outlet	16P289	15M669	1

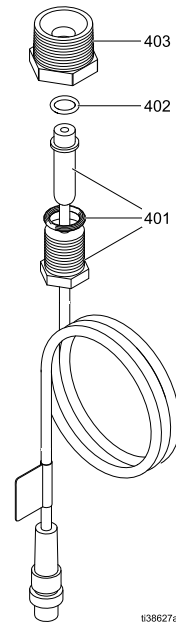

### Pressure Transducer Kit for Sanitary Pumps 24X089

Ref	Description	Part	Qty
501	MANIFOLD, 1.5 in. sanitary, transducer	17D233	1
502	SENSOR, pressure, fluid outlet	16P289	1
503	PACKING, o-ring	119348	1
504	CLAMP, sanitary, 1.5 in.	118598	1
505	GASKET, sanitary	120351	1

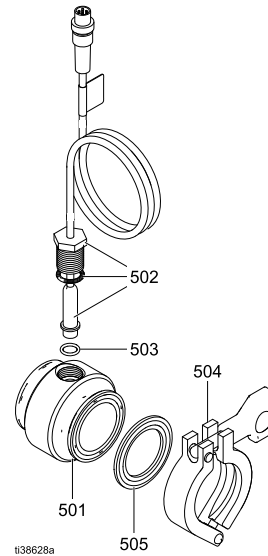

### Technical Specifications for 24R050, 24Y245, and 24X089

Pressure Transducer Kits 24R050, 24Y245, and 24X089	US	Metric
<b>Electrical Ratings:</b>		
Voltage	5 VDC	
Full Scale sensitivity	20.00 mV/V	
Span At Max pressure	100 mV	
Ambient Temperature	32°F – 140°F	0°C – 60°C
<b>EX Ratings:</b>		
Classification	"Simple Apparatus" in accordance with UL/EN/IEC 60079-11, clause 5.7 Class I, Div 1: Group D T4 	
Parameters	U <sub>i</sub> = 17.9 V I <sub>i</sub> = 73 mA P <sub>i</sub> = 1.3 W C <sub>i</sub> = 900 pF L <sub>i</sub> = 1.7 μH L <sub>i</sub> /R <sub>i</sub> = 6.6 μH/Ohm	

## California Proposition 65

#### CALIFORNIA RESIDENTS

 **WARNING:** Cancer and reproductive harm — [www.P65warnings.ca.gov](http://www.P65warnings.ca.gov).

## Appendix A - Modbus Variable Map

To communicate through fiber optics with the E-Flo DC Control Module, reference the appropriate hardware as shown in manual 332356. That manual indicates various options for connecting fiber optic cables from the control module to the non-hazardous area. The following tables list Modbus registers available to a PC or PLC located in the non-hazardous area.

Table 3 shows the registers needed for basic operation, monitoring, and alarm control features. Tables 4 and 5 provide bit definitions as needed for certain registers. Table 6 shows the units and how to convert the register value to a unit value.

**Table 3 Pump Configuration Registers**

ADCM Modbus Register	Parameter Name	Range	Register Access
403100	timeHour_u8	0–23	Read
403101	timeMinute_u8	0–59	Read
403102	timeSecond_u8	0–59	Read
403103	dateYear_u8	0–99	Read
403104	dateMonth_u8	1–12	Read
403105	dateDay_u8	1–31	Read
403106	Active Alarms Upper	See Event Table	Read
403107	Active Alarms Lower	See Event Table	Read

403200	timeHour_u8	0–23	Read/Write
403201	timeMinute_u8	0–59	Read/Write
403202	timeSecond_u8	0–59	Read/Write
403203	dateYear_u8	0–99	Read/Write
403204	dateMonth_u8	1–12	Read/Write
403205	dateDay_u8	1–31	Read/Write
403206	displayPassword_u32	0-9999	Read/Write
403207	displayDateFormat_enum	0 = MMDDYY 1 = DDMMYY 2 = YYMMDD	Read/Write
403208	PressureUnits	0 = PSI 1 = BAR 2 = MPA	Read/Write
403209	VolumeUnits	0 = Gallons 1 = Liters	Read/Write
403210	FlowUnits	0 = Liter/min 1 = Gallons / min 2 = cc/min 3 = oz/min 4 = cycles/min	Read/Write
403211	ProfileLock	0 = unlocked 1 = locked	Read/Write

ADCM Modbus Register	Parameter Name	Range	Register Access
403212	Tranducer_1_type	0 = None 1 = 500 psi	Read/Write
403213	Reserved		
403214	Transducer_1_Scale Upper	0-65535	Read
403215	Transducer_1_Scale Lower	0-65535	Read
403216	Transducer_1_Offset Upper	0-65535	Read
403217	Transducer_1_Offset Lower	0-65535	Read
403218	Transducer_2_type	0 = None 1 = 500 psi	Read/Write
403219	Reserved		
403220	Transducer_2_Scale Upper	0-65535	Read
403221	Transducer_2_Scale Lower	0-65535	Read
403222	Transducer_2_Offset Upper	0-65535	Read
403223	Transducer_2_Offset Lower	0-65535	Read
403224	DisableRemoteStart_bool	0 = Remote Start Enabled 1 = Remote Start Disabled	Read/Write

**Table 4 Pump Run Registers**

ADCM Modbus Register	Parameter Name	Range	Register Access
404100	Pump Status Bits	bit 0 = Pump trying to move bit 1 = Pump actually moving bit 2 = Active Alarm bit 3 = Active Deviation bit 4 = Active Advisory bit 5 = Setup Modified (Registers 6141-6159) bit 6 = Pump Direction bit 7 = Run Status bit 8 = Profile 1 Modified bit 9 = Profile 2 Modified bit 10 = Profile 3 Modified bit 11 = Profile 4 Modified	Read
404101	Actual Pump Speed	10 = 1.0 cycle/min	Read
404102	Actual Pump Flow Rate	10 = 1.0 L/min 10 = 1.0 Gal/min 1 = 1 cc/min 1 = 1 oz/min 10 = 1.0 cycle/min	Read
404103	Estimated Pump Force or Pressure	0-100	Read
404104	Transducer 1 Pressure	1 = 1 psi 10 = 1.0 Bar 100 = 1.00 Mpa	Read

Appendix A - Modbus Variable Map

ADCM Modbus Register	Parameter Name	Range	Register Access
404105	Transducer 2 Pressure	1 = 1 psi 10 = 1.0 Bar 100 = 1.00 Mpa	Read
404106	Batch Total High Word	0 - 65535	Read
404107	Batch Total Low Word	0 - 65535	Read
404108	Grand Total High Word Pump 1	0 - 65535	Read
404109	Grand Total Low Word Pump 1	0 - 65535	Read
404110	Maintenance Total High Word	0 - 65535	Read
404111	Maintenance Total Low Word	0 - 65535	Read
404112	Pump Alarms High Word	See Event Table	Read
404113	Pump Alarms Low Word	See Event Table	Read
404114	Reserved		
404115	Reserved		
404116	Reserved		
404117	Reserved		
404118	Reserved		
404119	Reserved		
404120	Display Version Major	0-99	Read
404121	Display Version Minor	0-99	Read
404122	Display Version Build	0-99	Read

404150	Active Profile Pressure Minimum	0 to maximum pressure for pump type	Read
404151	Active Profile Pressure	0 to maximum pressure for pump type	Read
404152	Active Profile Pressure	0 to maximum pressure for pump type	Read
404153	Active Profile Flow	0 to maximum pressure for pump type	Read
404154	Active Profile Flow	0 to maximum pressure for pump type	Read
404155	Active Profile Flow	0 to maximum pressure for pump type	Read
404156	Active Profile Mode	0 = Pressure 1 = Flow 2 = Hybrid	Read
404157	Active BPR % Closed	0-100	Read
404158	Active Pressure Minimum Event Type	0 = Limit 1 = Deviation 2 = Alarm	Read



ADCM Modbus Register	Parameter Name	Range	Register Access
404159	Active Pressure Maximum Event Type	0 = Limit 1 = Deviation 2 = Alarm	Read
404160	Active Flow Rate Minimum Event Type	0 = Limit 1 = Deviation 2 = Alarm	Read
404161	Active Flow Rate Maximum Event Type	0 = Limit 1 = Deviation 2 = Alarm	Read
404200	Local/Remote Control	0 = Local 1 = Remote	Read/Write
404201	Active Profile	1-4	Read/Write
404202	Reset Event		Read/Write
404203	Maintenance Interval Upper	0 - 65535	Read/Write
404204	Maintenance Interval Lower	0 - 65535	Read/Write
404205	Reserved		
404206	Reserved		
404207	Reserved		
404208	Reserved		
404209	Reserved		
404210	Pump Lower Type		Read/Write
404211	Pump Lower Size		Read/Write
404212	Reserved		
404213	Reserved		
404214	Stop BPR %	1-100	Read/Write
404250	Password Enable	0 = Disabled 1 = Enabled	Read/Write
404251	ProfileLock	0 = unlocked 1 = locked	Read/Write

**Table 5 Profile Registers**

ADCM Modbus Register	Parameter Name	Range	Register Access
405x00	Profile x Min Pressure	0 to maximum pressure for pump type	Read/Write
405x01	Profile x Profile Target Pressure	0 to maximum pressure for pump type	Read/Write

Appendix A - Modbus Variable Map

ADCM Modbus Register	Parameter Name	Range	Register Access
405x02	Profile x Profile Max Pressure	0 to maximum pressure for pump type	Read/Write
405x03	Profile x Profile Min Flow	0 to maximum pressure for pump type	Read/Write
405x04	Profile x Profile Target Flow	0 to maximum pressure for pump type	Read/Write
405x05	Profile x Profile Max Flow	0 to maximum pressure for pump type	Read/Write
405x06	Profile x Profile Mode Select	0 = Pressure 1 = Flow 2 = Hybrid	Read/Write
405x07	Profile x Analog Output #1 BPR Cntrl (4 - 20 ma)	0-100	Read/Write
405x08	Profile x Profile Min Pressure Alarm Type	0 = Limit 1 = Deviation 2 = Alarm	Read/Write
405x09	Profile x Profile Max Alarm Type	0 = Limit 1 = Deviation 2 = Alarm	Read/Write
405x10	Profile x Profile Min Flow Alarm Type	0 = Limit 1 = Deviation 2 = Alarm	Read/Write
405x11	Profile x Profile Max Flow Alarm Type	0 = Limit 1 = Deviation 2 = Alarm	Read/Write
405x12 - 405x15	Reserved		

Table 6 IPK Registers

ADCM Modbus Register	Parameter Name	Range	Register Access
406100	Secs Counter	0 - 60	Read
406101	Pump Status Bits	bit 0 = Pump trying to move bit 1 = Pump actually moving bit 2 = Active Alarm bit 3 = Active Deviation bit 4 = Active Advisory bit 5 = Setup Modified (Registers 6141-6159) bit 6 = Pump Direction bit 7 = Run Status bit 8 = Profile 1 Modified bit 9 = Profile 2 Modified bit 10 = Profile 3 Modified bit 11 = Profile 4 Modified	Read
406102	Actual Pump Speed	10 = 1.0 cycle/min	Read

ADCM Modbus Register	Parameter Name	Range	Register Access
406103	Actual Pump Flow Rate	10 = 1.0 L/min 10 = 1.0 Gal/min 1 = 1 cc/min 1 = 1 oz/min 10 = 1.0 cycle/min	Read
406104	Estimated Pump Force or Pressure	0-100	Read
406105	Transducer 1 Pressure	1 = 1 psi 10 = 1.0 Bar 100 = 1.00 Mpa	Read
406106	Transducer 2 Pressure	1 = 1 psi 10 = 1.0 Bar 100 = 1.00 Mpa	Read
406107	Reserved		
406108	ADCM Output Bits	bit 0: Aux Output 0 = Off 1 = On	Read/Write
406109	Active Profile Number	0 - 4	Read/Write
406110	Reserved		
406111	Reserved		
406112	Reserved		
406113	Reserved		
406114	Batch Total High Word	0 - 65535	Read Only
406115	Batch Total Low Word	0 - 65535	Read Only
406116	Grand Total High Word Pump 1	0 - 65535	Read Only
406117	Grand Total Low Word Pump 1	0 - 65535	Read Only
406118	Reserved		
406119	Reserved		
406120	Reserved		
406121	Last Up Time	0-65535 ms	Read
406122	Last Down Time	0-65535 ms	Read
406123	BPR Target	0-100	Read/Write
406124	Reserved		
406125	Reserved		
406126	Reserved		
406127	Reserved		
406128	Reserved		
406129	Pump Alarms High Word		Read
406130	Pump Alarms Low Word		Read
406131	Reserved		

Appendix A - Modbus Variable Map

ADCM Modbus Register	Parameter Name	Range	Register Access
406132	Reserved		
406133	Reserved		
406134	Reserved		
406135	Reserved		
406136	Reserved		
406137	Reserved		
406138	Reserved		
406139	Pump Control Bitfield	bit 0 = Clear Alarm bit 1 = Reset Batch bit 2 = Reset Maint Counter	Read/Write
406140	Configuration	bit 0: 0 = Local 1 = Remote bit 1: Profile 4 Circ 0 = Standard 1 = Circ Profile bit 2: Transducer 1 0 = Disabled 1 = Enabled bit 3: Transducer 2 0 = Disabled 1 = Enabled bit 15: Remote Start 0 = Enable 1 = Disable	Read/Write
406141	Reserved		
406142	Pressure Units	0 = Psi 1 = bar 2 = Mpa	Read/Write
406143	Volume Units	0 = Liters 1 = Gallons	Read/Write
406144	Flow Units	0 = Liter/min 1 = Gallons/min 2 = cc/min 3 = oz/min 4 = Cycles / min	Read/Write
406145	Reserved		
406146	Stop Profile BPR % Setting	0-100	Read/Write
406147	Reserved		
406148	Reserved		
406149	Reserved		
406150	Reserved		
406151	Reserved		
406152	Reserved		

ADCM Modbus Register	Parameter Name	Range	Register Access
406153	Reserved		
406154	Reserved		
406155	Pump Ratio	0–65353	Read/Write
406156	Pump Lower Size	0-65535 cc	Read/Write

**NOTE:** See [Error Code Troubleshooting, page 35](#), for a description of each alarm.

**Table 7 Alarm Bits**

404112 - Pump Events — High Word			
Bit	Event Type	Event Code	Event Name
0		DD91	Pump Diving Down
1		DD92	Pump Diving Up
2		CAGX	Modbus Communication Deviation
3		C4GX	Modbus Communication Alarm
4		MND1	Maintenance Interval Expired
5		WSC1	Invalid Pressure Target
6		WSC2	Invalid Flow Rate Target
7		WSD1	Invalid Lower Size
8		WSD2	Invalid Pump Ratio
9	Reserved		
10	Reserved		
11	Reserved		
12	Reserved		
13	Reserved		
14	Reserved		
15	Reserved		
404113 - Pump Events — Low Word			
Bit	Event Type	Event Code	Event Name
0	Alarm	K1D0	Minimum Flow Rate Alarm
1	Deviation	K2D0	Minimum Flow Rate Deviation
2	Deviation	K3D0	Maximum Flow Rate Deviation
3	Alarm	K4D0	Maximum Flow Rate Alarm
4	Alarm	P1I0	Minimum Pump Outlet Fluid Pressure Alarm
5	Deviation	P2I0	Minimum Pump Outlet Fluid Pressure Deviation
6	Deviation	P3I0	Maximum Pump Outlet Fluid Pressure Deviation
7	Alarm	P4I0	Maximum Pump Outlet Fluid Pressure Alarm

Appendix A - Modbus Variable Map

8	Alarm	P6I0	Pump Outlet Pressure Sensor Failure
9	Alarm	P1CB	Minimum BPR Pressure Alarm
10	Deviation	P2CB	Minimum BPR Pressure Deviation
11	Deviation	P3CB	Maximum BPR Pressure Deviation
12	Alarm	P4CB	Maximum BPR Pressure Alarm
13	Alarm	P6CB	BPR Pressure Sensor Failure
14	Deviation	DK61	Reed Switch 1 Not Detected
15	Deviation	DK62	Reed Switch 2 Not Detected

**Table 8 404100 - Pump Status Bits**

404100 - Pump Status Bits	
Bit	Meaning
0	Reads 1 if the pump is trying to move
1	Reads 1 if the pump is actually moving
2	Reads 1 if there are any active alarms
3	Reads 1 if there are any active deviations
4	Reads 1 if there are any active advisories
5	Setup changed
6	Reserved
7	Run/Stop switch closed
8	Profile 1 changed
9	Profile 2 changed
10	Profile 3 changed
11	Profile 4 changed

**Table 9 404202 - Pump Control Bits**

404202 - Pump Control Bits	
Bit	Meaning
0	Reads 0 for an active alarm or deviation. Reset to 1 to clear.
1	Set to 1 to reset the batch total
2	Set to 1 to reset the maintenance counter
others	Reserved for future use - only write 0

**Table 10 406140 - Pump Status and Configuration Bits**

406140 - Pump Status Bits	
Bit	Meaning
0	Pump is trying to moved 0 = Pump is off 1 = Pump is on

1	Pump is moving 0 = Pump is stalled (CPM is less than 1) 1 = Pump is moving at more than 1 CPM
2	Active Alarm 0 = No active alarm 1 = Active alarm
3	Active Deviation 0 = No active deviation 1 = Active deviation
4	Active Advisory 0 = No active advisory 1 = Active advisory
5	Setup Changed
6	Reserved
7	Reserved
8	Profile 1 Changed 0 = Profile not modified 1 = Profile modified (bit is cleared automatically upon reading profile 1)
9	Profile 2 Changed 0 = Profile not modified 1 = Profile modified (bit is cleared automatically upon reading profile 2)
10	Profile 3 Changed 0 = Profile not modified 1 = Profile modified (bit is cleared automatically upon reading profile 3)
11	Profile 4 Changed 0 = Profile not modified 1 = Profile modified (bit is cleared automatically upon reading profile 4)
12	Reserved
13	Reserved
14	Reserved
15	Reserved
<b>404202 - Pump Control Bits</b>	
<b>Bit</b>	<b>Meaning</b>
0	Control Mode 0 = Local (only accept commands from local display) 1 = Remote
1	Enable Off Production Profile - Profile 4 is now used as the off production profile 0 = Disable 1 = Enable
2	Enable Pressure Transducer 1 0 = Disable 1 = Enable
3	Enable Pressure Transducer 2 0 = Disable 1 = Enable
4	Reserved
5	Reserved

*Appendix A - Modbus Variable Map*

6	Reserved
7	Reserved
8	Reserved
9	Reserved
10	Reserved
11	Reserved
12	Reserved
13	Reserved
14	Reserved
15	Remote Start - System can be turned on by PLC or remote source 0 = Enabled 1 = Disabled





Table 11 Units

Unit Type	Selectable Units	Units Register	Converting registers to unit values	Register value for 1 unit
Pressure	Percent	n/a	Pressure = Register	1 = 1% Pressure
Pressure	psi	403208 = 0	Pressure = Register	1 = 1 psi
	Bar	403208 = 1	Pressure = Register/10	10 = 1.0 Bar
	MPa	403208 = 2	Pressure = Register/100	100 = 1.00 Mpa
Speed	Cycles/min	n/a	Speed = Register/10	10 = 1.0 cycle/min
Flow	Liters/min	403210 = 0	Flow = Register/10	10 = 1.0 L/min
	Gallons/min	403210 = 1	Flow = Register/10	10 = 1.0 Gal/min
	cc/min	403210 = 2	Flow = Register	1 = 1 cc/min
	oz/min	403210 = 3	Flow = Register	1 = 1 oz/min
	Cycles/min	403210 = 4	Flow = Register/10	10 = 1.0 cycle/min
Volume	Liters	403209 = 0	Volume = 1000*High + Low/10	0 (High) / 10 (Low) = 1.0 L
	Gallons	403209 = 1	Volume = 1000*High + Low/10	0 (High) / 10 (Low) = 1.0 Gal
Cycles	Pump Cycles	n/a	Cycles = 10000*High + Low	0 (High) / 1 (Low) = 1 cycle

= Example of converting volume register reading to units: If the reading for register 404106 (volume high word) is 12, and the reading for register 404107 (volume low word) is 34, the volume is 12003.4 liters.  $12 * 1000 + 34/10 = 12003.4$ .

== Example of converting cycles register reading to units: If the reading for register 404108 (cycles high word) is 75, and the reading for register 404109 (cycles low word) is 8000, the volume is 758,000 cycles.  $75 * 10000 + 8000 = 758000$ .

# Appendix B - Control Module Programming

				
<p>To help prevent fire and explosion, do not connect, download, or remove the token unless the unit is removed from the hazardous (explosive atmosphere) location.</p>				

- **All data in the module may be reset to factory default settings.** Record all settings and user preferences before the upgrade, for ease of restoring them following the upgrade.
- The latest software version for each system can be found at [www.graco.com](http://www.graco.com).

## Software Upgrade Instructions

**NOTE:** If the software on the token is the same version that is already programmed on the module, nothing will happen (including flashing red light). No harm can be done by attempting to program the module multiple times.

1. Remove power from the Pump Control Module by turning off system power and move the Pump Control Module to a non-hazardous location.
2. Remove access cover (C).

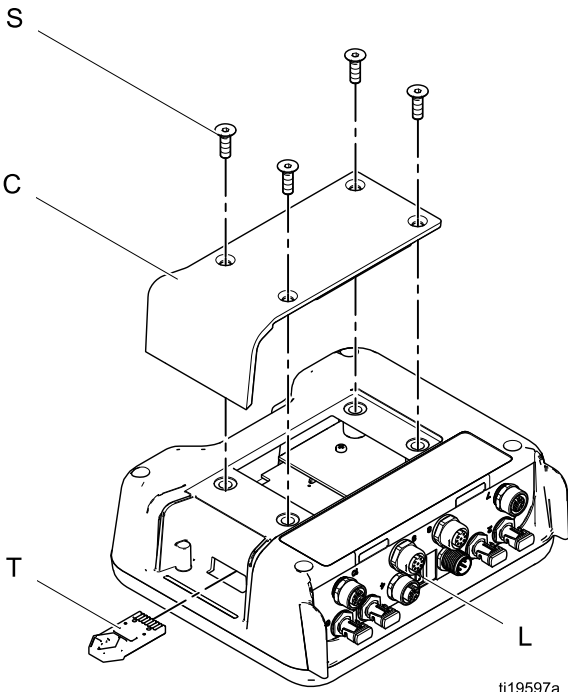

3. Insert and press the token (T) firmly into the slot. **NOTE:** Token has no preferred orientation.
4. Return the unit to the hazardous location.
5. Supply electrical power to the Graco Control Module.
6. The red indicator light (L) will flash while the software is being loaded on the display. When the software is completely loaded, the red light will turn off.

<b>NOTICE</b>
<p>To prevent corrupting the software, do not remove the token, turn off the system power, or disconnect any modules until the status screen indicates that updates are complete.</p>

7. The following screen will be shown when the display turns on.



*Communications with motors established.*

8. Wait for update to complete. **NOTE:** The approximate time until completion is shown along bottom of progress bar.

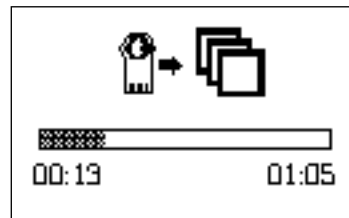

9. Updates are complete. Icon indicates update success or failure.

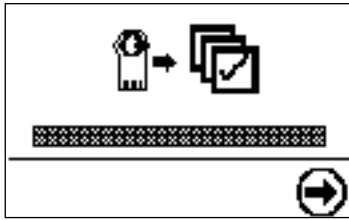

Icon	Description
	Update successful
	Update unsuccessful
	Update complete; no change necessary

10. Remove power from the Pump Control Module by turning off the system power and move the Pump Control Module to a non-hazardous location.
11. Remove the access cover (C).
12. Remove the token (T) from its slot.
13. Reinstall the access cover (C) and secure with screws (S).
14. Return the Pump Control Module to the hazardous location and apply power.

# Graco Standard Warranty

Graco warrants all equipment referenced in this document which is manufactured by Graco and bearing its name to be free from defects in material and workmanship on the date of sale to the original purchaser for use. With the exception of any special, extended, or limited warranty published by Graco, Graco will, for a period of twelve months from the date of sale, repair or replace any part of the equipment determined by Graco to be defective. This warranty applies only when the equipment is installed, operated and maintained in accordance with Graco's written recommendations.

This warranty does not cover, and Graco shall not be liable for general wear and tear, or any malfunction, damage or wear caused by faulty installation, misapplication, abrasion, corrosion, inadequate or improper maintenance, negligence, accident, tampering, or substitution of non-Graco component parts. Nor shall Graco be liable for malfunction, damage or wear caused by the incompatibility of Graco equipment with structures, accessories, equipment or materials not supplied by Graco, or the improper design, manufacture, installation, operation or maintenance of structures, accessories, equipment or materials not supplied by Graco.

This warranty is conditioned upon the prepaid return of the equipment claimed to be defective to an authorized Graco distributor for verification of the claimed defect. If the claimed defect is verified, Graco will repair or replace free of charge any defective parts. The equipment will be returned to the original purchaser transportation prepaid. If inspection of the equipment does not disclose any defect in material or workmanship, repairs will be made at a reasonable charge, which charges may include the costs of parts, labor, and transportation.

**THIS WARRANTY IS EXCLUSIVE, AND IS IN LIEU OF ANY OTHER WARRANTIES, EXPRESS OR IMPLIED, INCLUDING BUT NOT LIMITED TO WARRANTY OF MERCHANTABILITY OR WARRANTY OF FITNESS FOR A PARTICULAR PURPOSE.**

Graco's sole obligation and buyer's sole remedy for any breach of warranty shall be as set forth above. The buyer agrees that no other remedy (including, but not limited to, incidental or consequential damages for lost profits, lost sales, injury to person or property, or any other incidental or consequential loss) shall be available. Any action for breach of warranty must be brought within two (2) years of the date of sale.

**GRACO MAKES NO WARRANTY, AND DISCLAIMS ALL IMPLIED WARRANTIES OF MERCHANTABILITY AND FITNESS FOR A PARTICULAR PURPOSE, IN CONNECTION WITH ACCESSORIES, EQUIPMENT, MATERIALS OR COMPONENTS SOLD BUT NOT MANUFACTURED BY GRACO.** These items sold, but not manufactured by Graco (such as electric motors, switches, hose, etc.), are subject to the warranty, if any, of their manufacturer. Graco will provide purchaser with reasonable assistance in making any claim for breach of these warranties.

In no event will Graco be liable for indirect, incidental, special or consequential damages resulting from Graco supplying equipment hereunder, or the furnishing, performance, or use of any products or other goods sold hereto, whether due to a breach of contract, breach of warranty, the negligence of Graco, or otherwise.

## FOR GRACO CANADA CUSTOMERS

The Parties acknowledge that they have required that the present document, as well as all documents, notices and legal proceedings entered into, given or instituted pursuant hereto or relating directly or indirectly hereto, be drawn up in English. Les parties reconnaissent avoir convenu que la rédaction du présente document sera en Anglais, ainsi que tous documents, avis et procédures judiciaires exécutés, donnés ou intentés, à la suite de ou en rapport, directement ou indirectement, avec les procédures concernées.

## Graco Information

For the latest information about Graco products, visit [www.graco.com](http://www.graco.com).  
For patent information, see [www.graco.com/patents](http://www.graco.com/patents).

**To place an order**, contact your Graco Distributor or call to identify the nearest distributor.

**Phone:** 612-623-6921 **or Toll Free:** 1-800-328-0211 **Fax:** 612-378-3505

All written and visual data contained in this document reflects the latest product information available at the time of publication. Graco reserves the right to make changes at any time without notice

Original Instructions. This manual contains English. MM 3A7709

**Graco Headquarters:** Minneapolis

**International Offices:** Belgium, China, Japan, Korea

**GRACO INC. AND SUBSIDIARIES • P.O. BOX 1441 • MINNEAPOLIS MN 55440-1441 • USA**

**Copyright 2019, Graco, Inc. All Graco manufacturing locations are registered to ISO 9001.**

[www.graco.com](http://www.graco.com)

Revision D, October 2022