



MAGNUM[®] TRUEAIRLESS[™]

Electric Airless Sprayer



OWNERS MANUAL

3A6430C EN

Project Painter Plus, X5, X7, LTS 15, LTS 17



Important Safety Instructions

Read all warnings and instructions in this manual, related manuals, and on the unit. Be familiar with the controls and the proper usage of the equipment. Save these instructions.



Questions?
888-541-9788

<http://magnum.graco.com/magop/>



Magnum Products Operational Videos
<http://magnum.graco.com/magop/>

For portable spray applications of water-based and oil-based non-flammable architectural paints and coatings only.

Not approved for use in explosive atmospheres or hazardous locations.

PROVEN QUALITY. LEADING TECHNOLOGY.

Before You Spray

Before You Spray

Review Warnings for Important Safety Information

Important! Read carefully and practice good safety habits.



Related Manuals

Repair: 3A5572
Gun: 312830 (SG)

Magnum Products Operational Videos
<http://magnum.graco.com/magop/>

Models

	VAC	Model	Maximum Working Pressure	Stand (Series)	Cart (Series)
 Intertek 110474 Certified to CAN/CSA C22.2 No. 68 Conforms to UL 1450	120 USA	Project Painter Plus	2800 psi	257025 (A) CAN257 (A)	
		X5	3000 psi	262800 (E) 17K437 (A) CAN800 (A)	
		LTS15	3000 psi	17K955 (A)	
		X7	3000 psi		262805 (D) CAN805 (A)
		LTS17	3000 psi		17K960 (A)

Online Resources

Visit Our Website:	magnum.graco.com
Operational Videos:	magnum.graco.com/magop/
Manuals:	magnum.graco.com/support/#manuals
Parts Online:	magnum.graco.com/partsonline/
Material Compatibility:	magnum.graco.com/downloads/MaterialCompatibility.pdf

Important User Information

Thank You for Your Purchase!

Before using your sprayer read this Owners Manual for complete instructions on proper use and safety warnings.

This sprayer is designed to provide superior spray performance with water-based and oil-based (mineral spirit-type) architectural paints and coatings. This user information is intended to help you understand the types of materials that can be used with your sprayer.

Please read the information on the material container label to determine if it can be used with your sprayer. Ask for a Safety Data Sheet (SDS) from your supplier. The container label and SDS will explain the contents of the material and the specific precautions related to it.

Paints, coatings and clean-up materials generally fit into one of the following **3 basic categories**:



WATER-BASED: The container label should indicate that the material can be cleaned up with soap and water. Your sprayer is compatible with this type of material. Your sprayer is **NOT** compatible with harsh cleaners such as chlorine bleach.



OIL-BASED: The container label should indicate that the material is COMBUSTIBLE and can be cleaned up with mineral spirits or paint thinner. The SDS must indicate that the flash point of the material is above 100° F. Your sprayer is compatible with this type of material. Use oil-based material outdoors or in a well-ventilated indoor area with a flow of fresh air. See the safety warnings in this manual.



FLAMMABLE: This type of material contains flammable solvents such as xylene, toluene, naphtha, MEK, lacquer thinner, acetone, denatured alcohol, and turpentine. The container label should indicate that this material is FLAMMABLE. This type of material is **NOT** compatible with your sprayer and **CANNOT** be used.



WARNING

FIRE AND EXPLOSION HAZARD

- Use only non-flammable or water-based materials, or non-flammable paint thinners. Do not use materials having flash points lower than 100° F (38° C). This includes, but is not limited to, acetone, xylene, toluene, or naphtha. For more information about your material, request Safety Data Sheet (SDS) from the supplier.
- Spraying flammable or combustible (oil-based) materials in a factory or fixed location must comply with NFPA 33 and OSHA 1910.94(c) requirements in the USA and with all similar local regulations in other countries.

Contents

Before You Spray	2
Important User Information	3
Contents	4
Warnings	5
Warning Labels, Tags, and Cards are available at no cost	8
Know Your Sprayer	9
Project Painter Plus	9
Know Your Sprayer	10
X5 and LTS15 Stand Models	10
Know Your Sprayer	11
X7 and LTS17 Cart Models	11
Know Your Controls	12
Set Up	13
Start Up	14
Pressure Relief Procedure	14
Flush Storage Fluid	15
Strain the Paint	16
Fill Pump (Prime Pump)	16
Fill Gun and Hose	16
Refilling Paint Pail	17
Blockages	17
Spraying	18
Start	18
Adjust Pressure Control	18
Spray Pattern Quality	18
Spray Techniques	19
Triggering Gun	19
Aiming Gun	19
Aligning Spray Pattern	19
Spray Tip and Pressure Selection	20
Clear Spray Tip Clog	21
Spray Tip Installation	21
Cleanup	23
Cleaning from a Pail	23
Cleanup with Power Flush Valve (Water-based materials only)	25
Clean the Gun and Gun Filter	26
Storage	27
Short Term Storage	27
Long Term Storage	27
Reference	29
Cleaning Fluid Compatibility	29
Static Grounding Instructions (Oil-Based Materials)	29
Quick Reference	30
Maintenance	31
Airless Hoses	31
Spray Tips	31
Storage/Priming Tool	31
Troubleshooting	33
Technical Specifications	37
Graco Standard Warranty	38

Warnings

The following warnings are for the setup, use, grounding, maintenance, and repair of this equipment. The exclamation point symbol alerts you to a general warning and the hazard symbols refer to procedure-specific risks. When these symbols appear in the body of this manual or on warning labels, refer back to these Warnings. Product-specific hazard symbols and warnings not covered in this section may appear throughout the body of this manual where applicable.

WARNING



GROUNDING

This product must be grounded. In the event of an electrical short circuit, grounding reduces the risk of electric shock by providing an escape wire for the electric current. This product is equipped with a cord having a grounding wire with an appropriate grounding plug. The plug must be plugged into an outlet that is properly installed and grounded in accordance with all local codes and ordinances.

- Improper installation of the grounding plug is able to result in a risk of electric shock.
- When repair or replacement of the cord or plug is required, do not connect the grounding wire to either flat blade terminal.
- The wire with insulation having an outer surface that is green with or without yellow stripes is the grounding wire.
- Check with a qualified electrician or serviceman when the grounding instructions are not completely understood, or when in doubt as to whether the product is properly grounded.
- Do not modify the plug provided; if it does not fit the outlet, have the proper outlet installed by a qualified electrician.
- This product is for use on a nominal 120V circuit and has a grounding plug similar to the plugs illustrated below.

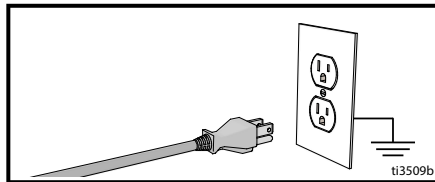

- Only connect the product to an outlet having the same configuration as the plug.
- Do not use a 3-to-2 adapter with this product.

Extension Cords:

- Use only a 3-wire extension cord that has a grounding plug and a grounding receptacle that accepts the plug on the product.
- Make sure your extension cord is not damaged. If an extension cord is necessary use 12 AWG (2.5mm²) minimum to carry the current that the product draws.
- An undersized cord results in a drop in line voltage and loss of power and overheating.

Conductor Size		Length
AWG (American Wire Gauge)	Metric	Maximum
16	1.5 mm ²	25 ft. (8 m)
12	2.5 mm ²	50 ft. (15 m)

WARNING



FIRE AND EXPLOSION HAZARD

Flammable fumes, such as solvent and paint fumes, in work area can ignite or explode. To help prevent fire and explosion:



- Do not spray or clean with materials having flash points lower than 100°F (38° C). Use only non-flammable or water-based materials, or non-flammable paint thinners. For complete information about your material, request the Safety Data Sheets (SDSs) from the material distributor or retailer.



- Do not spray combustible (oil-based) materials near an open flame or sources of ignition such as cigarettes, motors, and electrical equipment.



- Paint or solvent flowing through the equipment is able to result in static electricity. Static electricity creates a risk of fire or explosion in the presence of paint or solvent fumes. All parts of the spray system, including the pump, hose assembly, spray gun, and objects in and around the spray area shall be properly grounded to protect against static discharge and sparks. Use Graco conductive or grounded high-pressure airless paint sprayer hoses.

- Verify that all containers and collection systems are grounded to prevent static discharge. Do not use pail liners unless they are anti-static or conductive.

- Connect to a grounded outlet and use grounded extensions cords. Do not use a 3-to-2 adapter.

- Do not use a paint or a solvent containing halogenated hydrocarbons.

- Do not spray combustible liquids in a confined area.

- Keep spray area well-ventilated. Keep a good supply of fresh air moving through the area.

- Sprayer generates sparks. Keep pump assembly in a well ventilated area a least 20 feet (6.1 m) from the spray area when spraying, flushing, cleaning, or servicing. Do not spray pump assembly.

- Do not smoke in the spray area or spray where sparks or flame is present.

- Do not operate light switches, engines, or similar spark producing products in the spray area.

- Keep area clean and free of paint or solvent containers, rags, and other flammable materials.

- Know the contents of the paints and solvents being sprayed. Read all Safety Data Sheets (SDSs) and container labels provided with the paints and solvents. Follow the paint and solvents manufacturer's safety instructions.

- Keep a working fire extinguisher in the work area.



ELECTRIC SHOCK HAZARD

This equipment must be grounded. Improper grounding, setup, or usage of the system can cause electric shock.



- Turn off and disconnect power cord before servicing equipment.

- Connect only to grounded electrical outlets.

- Use only 3-wire extension cords.

- Ensure ground prongs are intact on power and extension cords.

- Do not expose to rain. Store indoors.

WARNING

SKIN INJECTION HAZARD



High-pressure spray is able to inject toxins into the body and cause serious bodily injury. In the event that injection occurs, **get immediate surgical treatment**.



- Do not aim the gun at, or spray any person or animal.
- Keep hands and other body parts away from the discharge. For example, do not try to stop leaks with any part of the body.



- Always use the nozzle tip guard. Do not spray without nozzle tip guard in place.



- Use Graco nozzle tips.



- Use caution when cleaning and changing nozzle tips. In the case where the nozzle tip clogs while spraying, follow the **Pressure Relief Procedure** for turning off the unit and relieving the pressure before removing the nozzle tip to clean.



- Equipment maintains pressure after power is shut off. Do not leave the equipment energized or under pressure while unattended. Follow the **Pressure Relief Procedure** when the equipment is unattended or not in use, and before servicing, cleaning, or removing parts.

- Check hoses and parts for signs of damage. Replace any damaged hoses or parts.

- This system is capable of producing 3000 psi (207 bar, 20.7 MPa). Use Graco replacement parts or accessories that are rated a minimum of 3000 psi (207 bar, 20.7 MPa).

- Always engage the trigger lock when not spraying. Verify the trigger lock is functioning properly.

- Verify that all connections are secure before operating the unit.

- Know how to stop the unit and bleed pressure quickly. Be thoroughly familiar with the controls.

EQUIPMENT MISUSE HAZARD



Misuse can cause death or serious injury.



- Always wear appropriate gloves, eye protection, and a respirator or mask when painting.

- Do not operate or spray near children. Keep children away from equipment at all times.

- Do not overreach or stand on an unstable support. Keep effective footing and balance at all times.

- Stay alert and watch what you are doing.

- Do not operate the unit when fatigued or under the influence of drugs or alcohol.

- Do not kink or over-bend the hose.

- Do not expose the hose to temperatures or to pressures in excess of those specified by Graco.

- Do not use the hose as a strength member to pull or lift the equipment.

- Do not spray with a hose shorter than 25 feet.

- Do not alter or modify equipment. Alterations or modifications may void agency approvals and create safety hazards.

- Make sure all equipment is rated and approved for the environment in which you are using it.

Warnings

WARNING

PRESSURIZED ALUMINUM PARTS HAZARD



Use of fluids that are incompatible with aluminum in pressurized equipment can cause serious chemical reaction and equipment rupture. Failure to follow this warning can result in death, serious injury, or property damage.

- Do not use 1,1,1-trichloroethane, methylene chloride, other halogenated hydrocarbon solvents or fluids containing such solvents.
- Do not use chlorine bleach.
- Many other fluids may contain chemicals that can react with aluminum. Contact your material supplier for compatibility.

MOVING PARTS HAZARD



Moving parts can pinch, cut, or amputate fingers and other body parts.

- Keep clear of moving parts.
- Do not operate equipment with protective guards or covers removed.
- Pressurized equipment can start without warning. Before checking, moving, or servicing equipment, follow the **Pressure Relief Procedure** and disconnect all power sources.



TOXIC FLUID OR FUMES HAZARD

Toxic fluids or fumes can cause serious injury or death if splashed in the eyes or on skin, inhaled, or swallowed.

- Read Safety Data Sheets (SDSs) to know the specific hazards of the fluids you are using.
- Store hazardous fluid in approved containers, and dispose of it according to applicable guidelines.



PERSONAL PROTECTIVE EQUIPMENT

Wear appropriate protective equipment when in the work area to help prevent serious injury, including eye injury, hearing loss, inhalation of toxic fumes, and burns. This protective equipment includes but is not limited to:

- Protective eyewear, and hearing protection.
- Respirators, protective clothing, and gloves as recommended by the fluid and solvent manufacturer.

CALIFORNIA PROPOSITION 65

This product contains a chemical known to the State of California to cause cancer, birth defects or other reproductive harm. Wash hands after handling.

Warning Labels, Tags, and Cards are available at no cost

Part Number	Description
17K627	Warning Label on Power Cord
15G026	Warning Tag on Airless Hose
179960	Medical Alert Card

Know Your Sprayer

Project Painter Plus

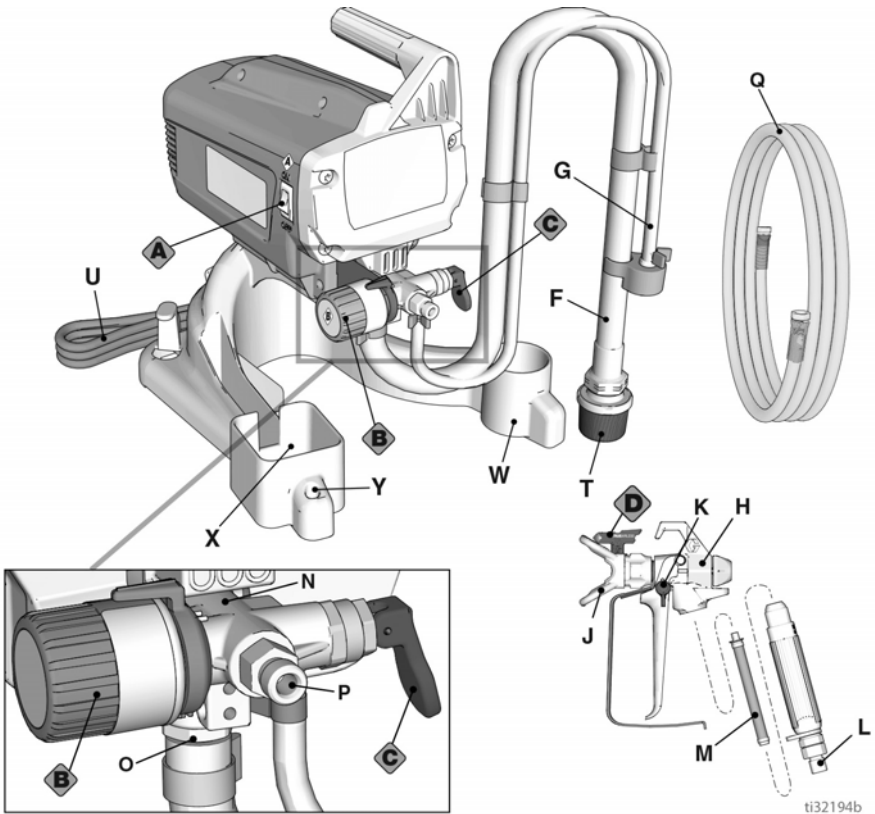

ti32194b

A	Power - ON/OFF Switch
B	Pressure Control Knob
C	Prime/Spray Valve
D	Spray Tip
F	Suction Tube
G	Drain Tube (with diffuser)
H	Airless Spray Gun
J	Spray Tip Guard
K	Gun Trigger Lock
L	Gun Fitting
M	Gun Filter (inside handle)

N	Pump
O	Inlet Valve
P	Outlet Valve (airless hose connection)
Q	Airless Hose
T	Inlet Screen
U	Power Cord
W	Suction Tube Drip Cup
X	Gun Holder
Y	Tip Holder
	Model/Serial Tag (Not Shown, located on bottom of unit)
See Quick Reference , page 30 for more information.	

Know Your Sprayer

Know Your Sprayer

X5 and LTS15 Stand Models

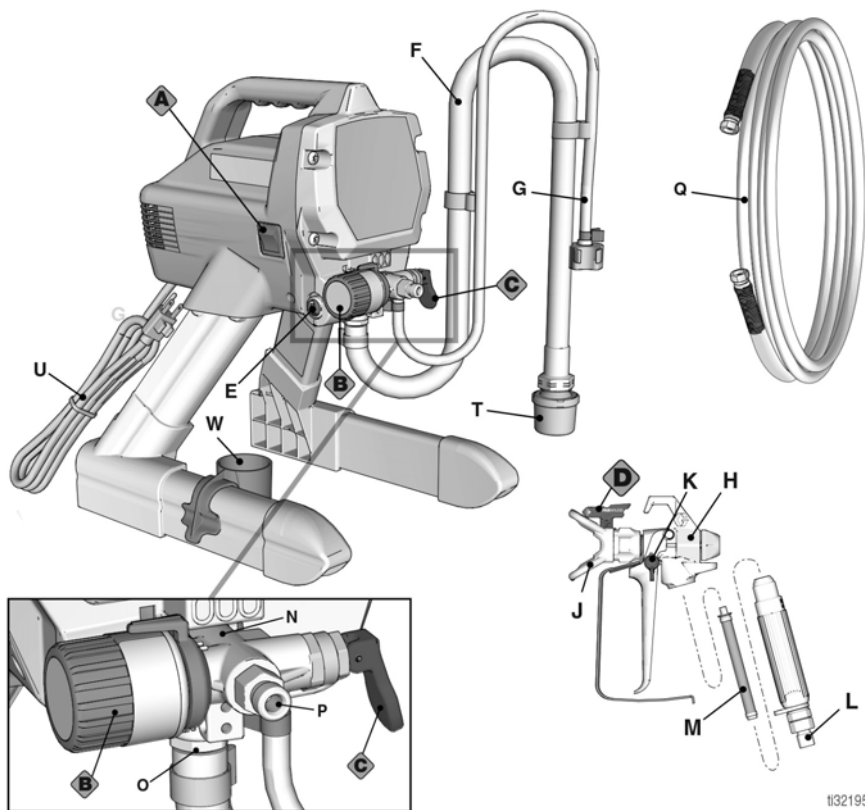

t132195b

A	Power - ON/OFF Switch
B	Pressure Control Knob
C	Prime/Spray Valve
D	Spray Tip
E	PushPrime™ Button
F	Suction Tube
G	Drain Tube (with diffuser)
H	Airless Spray Gun
J	Spray Tip Guard
K	Gun Trigger Lock
L	Gun Fitting

M	Gun Filter (inside handle)
N	Pump
O	Inlet Valve
P	Outlet Valve (airless hose connection)
Q	Airless Hose
T	Inlet Screen
U	Power Cord
W	Suction Tube Drip Cup
	Model/Serial Tag (Not shown, located on bottom of unit.)

See **Quick Reference**, page 30 for more information.

Know Your Sprayer

X7 and LTS17 Cart Models

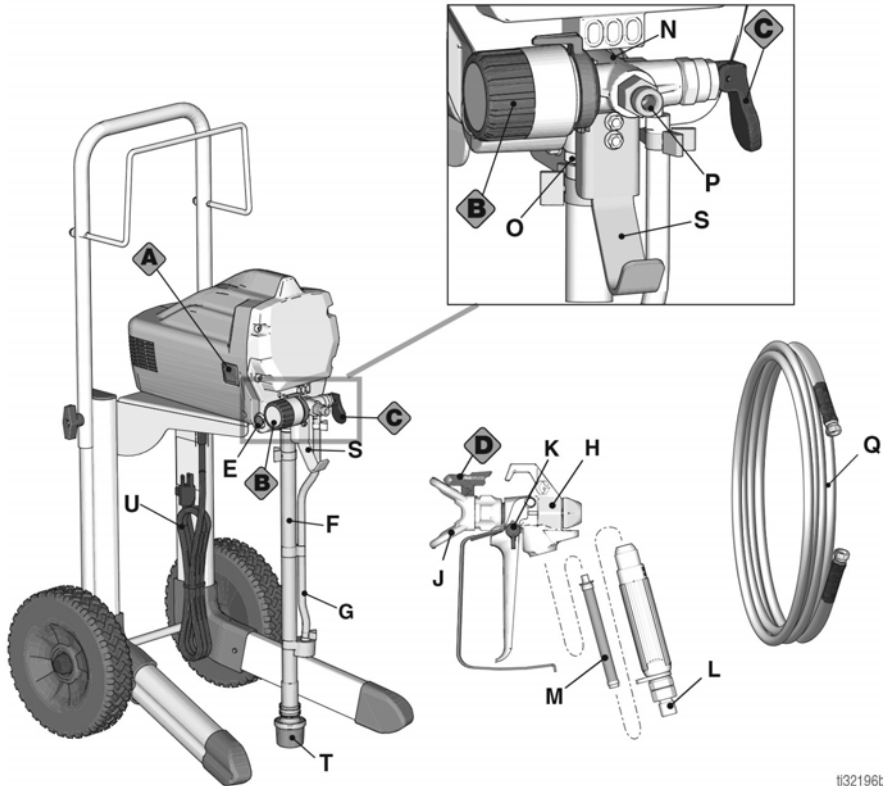





1132196b

A	Power - ON/OFF Switch
B	Pressure Control Knob
C	Prime/Spray Valve
D	Spray Tip
E	PushPrime™ Button
F	Suction Tube
G	Drain Tube (with diffuser)
H	Airless Spray Gun
J	Spray Tip Guard
K	Gun Trigger Lock
L	Gun Fitting

M	Gun Filter (inside handle)
N	Pump
O	Inlet Valve
P	Outlet Valve (airless hose connection)
Q	Airless Hose
S	Pail Hanger
T	Inlet Screen
U	Power Cord
	Model/Serial Tag (Not shown, located on bottom of unit.)
See Quick Reference , page 30 for more information.	

Know Your Controls

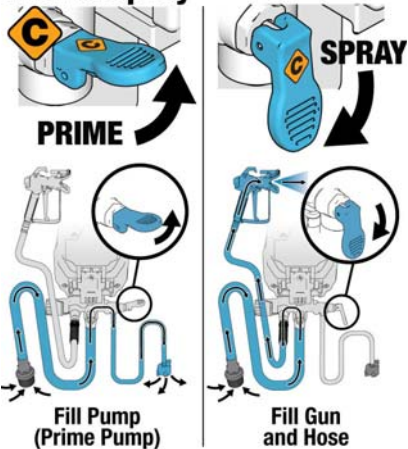
Know Your Controls

<p>Power</p>  <p>A yellow diamond warning symbol with the letter 'A' is shown next to a rectangular power switch. The switch has 'ON/O' and 'OFF/O' labels.</p>	<p>The ON/OFF power switch controls the main power to your sprayer.</p>
<p>Pressure</p>  <p>A yellow diamond warning symbol with the letter 'B' is shown next to a blue pressure control knob. The knob has a minus sign (-) on the left and a plus sign (+) on the right.</p>	<p>The Pressure Control knob increases or decreases the pressure and flow of the paint.</p>
<p>Prime/Spray</p>  <p>The diagram shows two positions of the Prime/Spray valve. On the left, the valve is in the 'PRIME' position, and a circular inset shows the valve handle being pushed down. Below this is a diagram of the sprayer with the hose and gun, labeled 'Fill Pump (Prime Pump)'. On the right, the valve is in the 'SPRAY' position, and a circular inset shows the valve handle being pulled up. Below this is a diagram of the sprayer with the hose and gun, labeled 'Fill Gun and Hose'.</p>	<p>The Prime/Spray Valve directs the fluid to either the Drain Tube or the hose and gun. It is used to prime the sprayer, which means to evacuate the air out of the pump, hose, and gun.</p> <p>Your gun will not spray if there is air in the system. It is necessary to prime the pump, hose, and gun any time air enters the Suction Tube.</p>
<p>Spray Tip</p>  <p>A yellow diamond warning symbol with the letter 'D' is shown next to two diagrams of the spray tip. The left diagram shows the tip in the 'SPRAY' position, and the right diagram shows it in the 'UNCLOG' position. A blue spray is shown coming out of the tip in the 'SPRAY' position.</p>	<p>The Spray Tip is the key to airless spray technology. High pressure paint pumped through the very small hole in the Spray Tip comes out as a spray.</p> <p>The Spray Tip has the ability to be reversed and quickly clear clogs.</p>

Set Up

Assemble Your Sprayer

1. Connect airless hose to airless hose connection (P) on sprayer. Use wrench to tighten securely.
2. Connect the other end of the hose to the gun. Use two wrenches to tighten securely to gun (see image below).

If hose is already connected, make sure connections are tight.

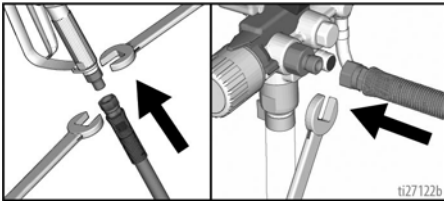

3. Assure Spray Tip is properly inserted into the Spray Tip Guard, and the Spray Tip Guard assembly is tightened securely to gun. See **Spray Tip Installation**, page 21.

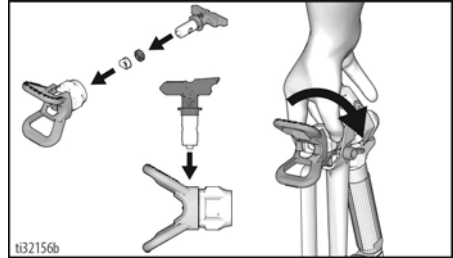

4. Perform the **Pressure Relief Procedure**, page 14.

Start Up

Start Up

Pressure Relief Procedure



Follow the Pressure Relief Procedure whenever you see this symbol.

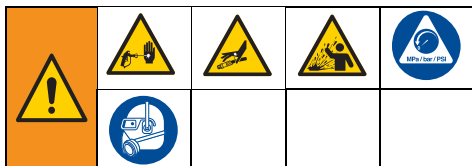

This equipment stays pressurized until pressure is manually relieved. To help prevent serious injury from pressurized fluid, such as skin injection or splashed fluid, follow the **Pressure Relief Procedure** whenever sprayer is stopped and before sprayer is cleaned or checked, and before equipment is serviced.

1. Turn ON/OFF switch to the **OFF** position.

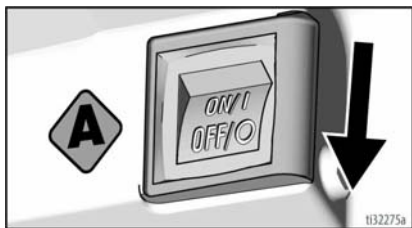

2. Engage the trigger lock. Always engage the trigger lock when sprayer is stopped to prevent the gun from being triggered accidentally.

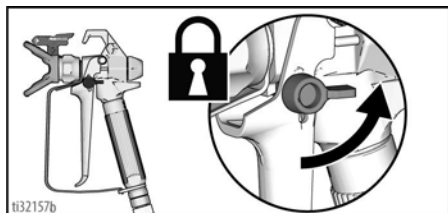

3. Turn pressure control knob to lowest setting.

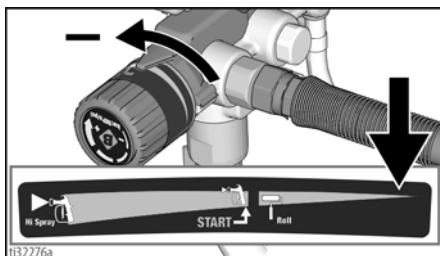

4. Put Drain Tube into a waste pail and lift Prime/Spray Valve in PRIME position to relieve pressure.

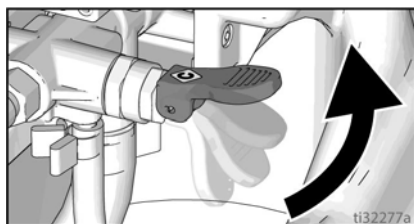

5. Hold the gun firmly to a pail. Point gun into pail. Disengage the trigger lock and trigger the gun to relieve pressure.

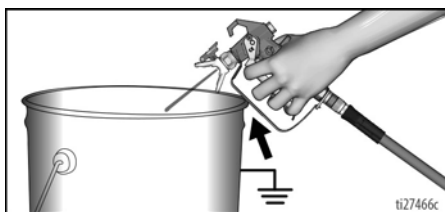

6. Engage the trigger lock.

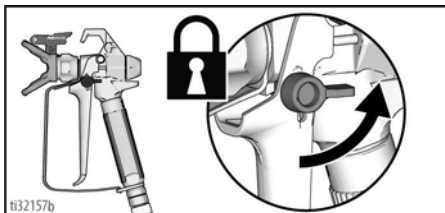

7. If you suspect that pressure has not been fully relieved, see **Blockages**, page 17.

NOTE: Leave Prime/Spray Valve in the PRIME position until you are ready to spray.

Flush Storage Fluid

It is important that you flush storage fluid from the sprayer before using it.

1. Make certain ON/OFF switch is **OFF**.
2. Separate Drain Tube (smaller) from Suction Tube (larger). Place Drain Tube in a waste pail.
3. Submerge Suction Tube into pail filled with water if spraying water-based material, or mineral spirits if spraying oil-based material.

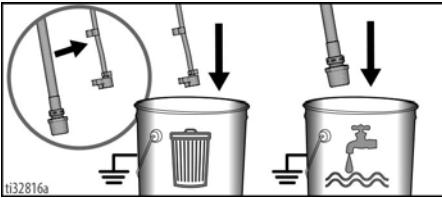

4. Lift Prime/Spray Valve to **PRIME** position.

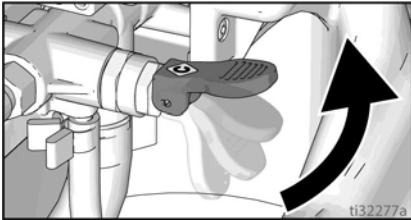

5. Plug power supply cord into a properly grounded electrical outlet.
6. For Project Painter Plus go to step 8. All other models, press the PushPrime button twice to loosen Inlet Valve ball.

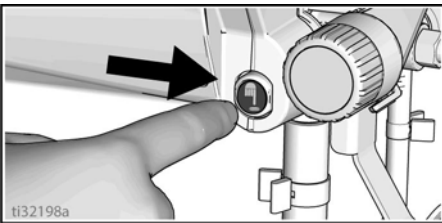

7. Align setting indicator with the **START** setting on the pressure control knob.

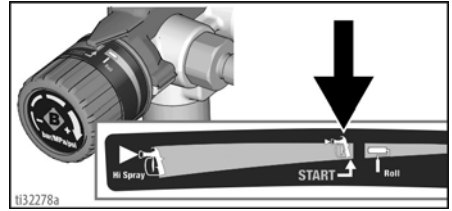

8. Turn ON/OFF switch to **ON** position.

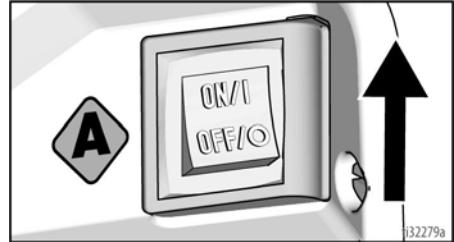

9. When sprayer starts pumping, flushing fluid will flow up the Suction Tube and out the Drain Tube. Allow fluid to flow out of Drain Tube, into waste pail, for 30 to 60 seconds.

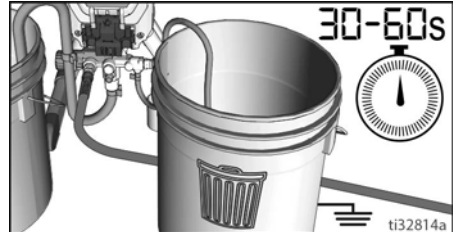

10. Turn the ON/OFF switch to **OFF** position.

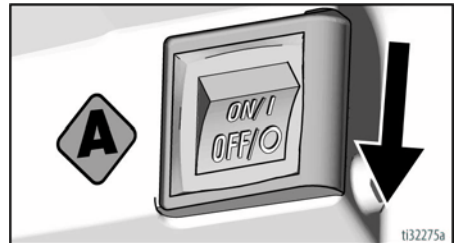





NOTE: If flushing fluid fails to come out of the Drain Tube, see **Storage/Priming Tool**, page 31.

Strain the Paint

Disposable paint strainer bags are used to remove coarse particles and debris from new or previously opened paint or stain, and are available where paint is sold. To avoid priming problems and Spray Tip clogs it is recommended to strain all paints and stains before spraying. Stretch a disposable paint strainer bag over a clean pail and pour the paint through the strainer.



				
<p>High-pressure spray is able to inject toxins into the body and cause serious bodily injury. Do not stop leaks with hand or rag.</p>				

Fill Pump (Prime Pump)

The Prime/Spray Valve directs the fluid to either the Drain Tube or the hose and gun. It is used to prime the sprayer, which means to evacuate the air out of the pump, hose, and gun.

Your gun will not spray if there is air in the system. It is necessary to prime the pump, hose, and gun any time air enters the suction tube.

1. Move Suction Tube to paint pail and submerge Suction Tube in paint.

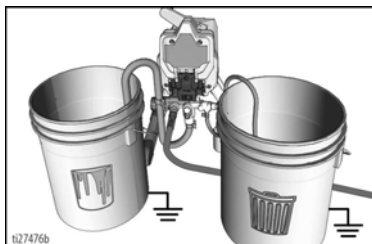

2. Turn ON/OFF switch to **ON** position.
3. Wait to see paint coming out of Drain Tube.
4. Turn ON/OFF switch to **OFF** position.

NOTE: If paint does NOT flow up the Suction Tube and out the Drain Tube, see **Flush Storage Fluid**, page 15.

Fill Gun and Hose

1. Rotate Spray Tip to **UNCLOG** position and ensure the Spray Tip Guard is tight.

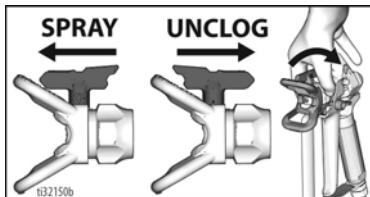

2. Hold gun against waste pail. Point gun into waste pail.
 - a. Disengage trigger lock (A).
 - b. Pull and hold gun trigger (B).
 - c. Lower Prime/Spray Valve to **SPRAY** position (C).
 - d. Turn ON/OFF switch to **ON** position (D).

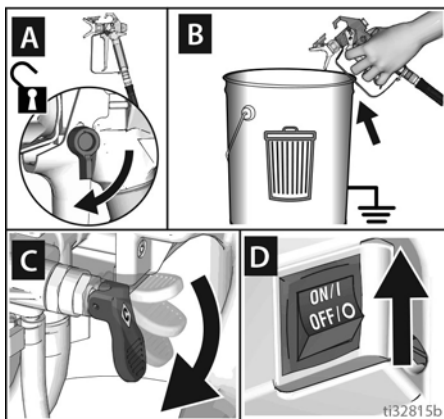

3. Trigger gun into waste pail until only paint comes out of the gun.

4. Release trigger. Engage trigger lock.

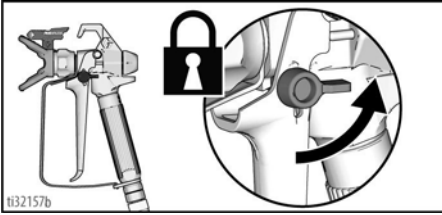

High-pressure spray is able to inject toxins into the body and cause serious bodily injury. Do not stop leaks with hand or rag.

- NOTE:** Inspect for leaks. If leaking occurs, perform **Pressure Relief Procedure**, page 14, then tighten all fittings and repeat **Fill Pump (Prime Pump)**, page 16.

5. Transfer Drain Tube to paint pail and clip to Suction Tube.

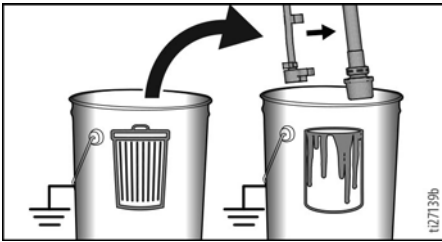

6. Rotate Spray Tip back to SPRAY position and ensure the Spray Tip Guard is tight.

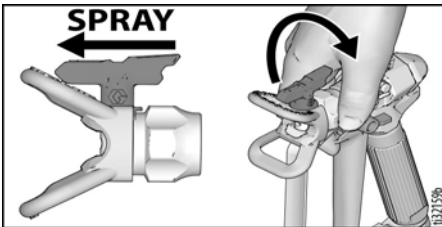

Refilling Paint Pail

When the paint pail runs low and the gun stops spraying, refill the paint pail and repeat the **Fill Pump (Prime Pump)** procedure, then the **Fill Gun and Hose** procedure.

You are now ready to spray!

NOTE: It is normal for the motor to stop once the sprayer is primed and under pressure. If the motor continues to run, the sprayer is not primed. Repeat the **Fill Pump (Prime Pump)** and **Fill Gun and Hose** processes.

Blockages

If paint does not come out of the gun, or if performing pressure relief procedure and you suspect pressure has not been fully relieved:

1. VERY SLOWLY loosen the hose connection to the gun and disconnect the airless spray hose from the gun.
2. Lower Prime/Spray Valve to SPRAY position.
3. While holding hose firmly, point end of hose into paint pail and turn ON/OFF switch to ON position.
 - a. If fluid does not flow out of hose, replace the hose and continue to step 4.
 - b. If fluid flows out of hose, see **Clean the Gun and Gun Filter**, page 26.
4. Reassemble the hose and gun, and repeat **Fill Gun and Hose**, page 16.

Spraying

Spraying



Start

1. Turn pressure control knob to **START** position.
2. Disengage trigger lock.

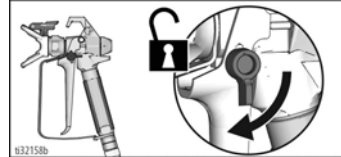
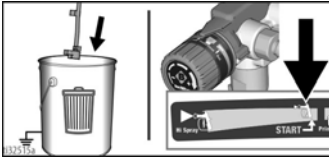

Adjust Pressure Control

To select a setting, align symbol on pressure control knob with setting indicator on sprayer.

1. For best spray results with lowest overspray, adjust pressure control to "**START**" setting.
2. Test the spray pattern on a test area or piece of cardboard.
3. If needed, increase Pressure Control Knob setting to minimum setting that results in an acceptable spray pattern.

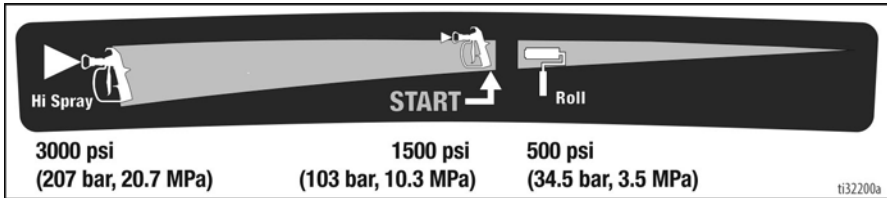

Spray Pattern Quality

A good spray pattern is evenly distributed as it hits the surface.

- Spray should be atomized (evenly distributed, no gaps at edges).
- Increase Pressure Control Knob if needed until spray is even and without gaps at edges.
- Spray Tip may be worn or a smaller tip may be needed. See **Spray Tip and Pressure Selection**, page 20.
- Material may need to be thinned. If material needs to be thinned follow manufacturer's recommendations.

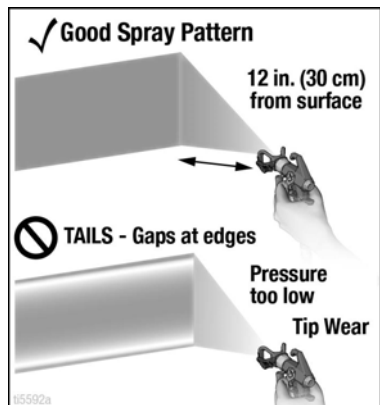

Spray Techniques

Use a piece of scrap cardboard to practice these basic spraying techniques before you begin spraying the surface.

- Hold gun 12 in. (30 cm) from surface and aim straight at surface. Tilting gun to direct spray angle causes an uneven finish.
- Flex wrist to keep gun pointed straight. Fanning gun to direct spray at angle causes uneven finish.

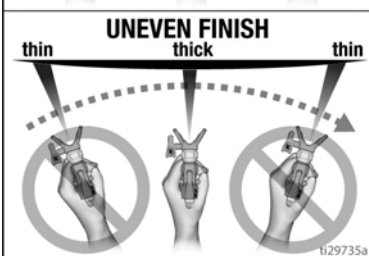
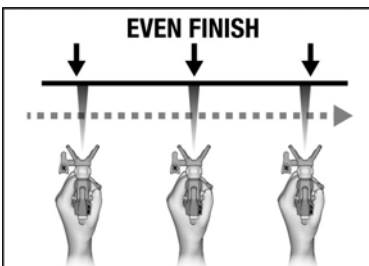
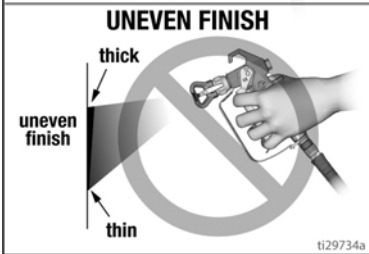
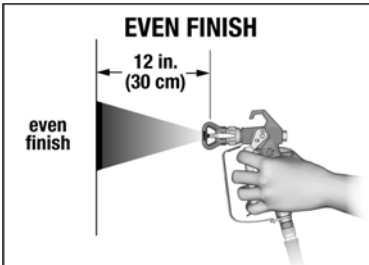

Triggering Gun

Pull trigger after starting stroke. Release trigger before end of stroke. Gun must be moving when trigger is pulled and released.

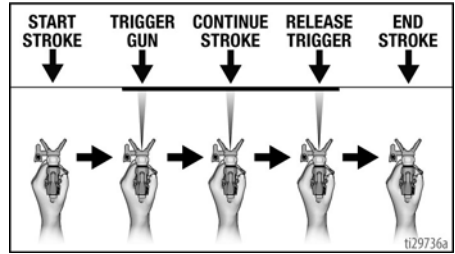

Aiming Gun

Aim center of spray of gun at bottom edge of previous stroke, overlapping each stroke by half.

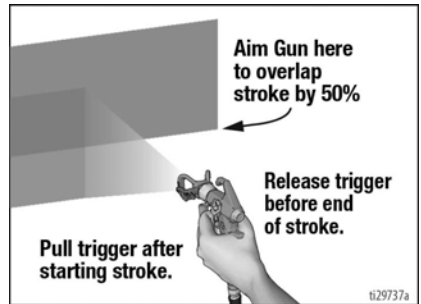

Aligning Spray Pattern



High-pressure spray is able to inject toxins into the body and cause serious bodily injury. Do not stop leaks with hand or rag.

1. Relieve pressure. See **Pressure Relief Procedure**, page 14. Engage trigger lock.
2. Align guard horizontally to spray a horizontal pattern.
3. Align guard vertically to spray a vertical pattern.

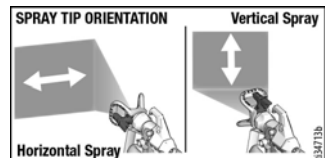

Spray Tip and Pressure Selection

Spray Tips come in a variety of sizes for spraying a wide range of materials. Your sprayer includes a 515 Spray Tip for use with most paints on large surfaces such as walls and ceilings. If you are spraying stain or need a different spray fan width, refer to the Spray Tip chart below to select the best Spray Tip for your project. Additional Spray Tip sizes are available where paint sprayers are sold.

- 1 What material are you spraying?
 - The thicker the material, the larger Spray Tip size you will need.
- 2 What spray fan width is needed for your project?
 - Narrow spray fan for smaller projects
 - Wider spray fan for larger projects
- 3 Confirm your sprayer can be used with your Spray Tip size.

Tip Number Calculation:

- The first digit is half of the fan width (#5 x 2 = 10 inch fan width).
- The last two digits are the size of the tip opening in thousandths of an inch.



1 Material	2 Fan Width					3 Sprayer Compatibility Each Sprayer Supports a Maximum Spray Tip Size
	4 in Fan Width	6 in Fan Width	8 in Fan Width	10 in Fan Width	12 in Fan Width	
Stain and Sealer	209	309				Project Painter Plus, X5/LTS15, X7/LTS17
	211	311	411			Project Painter Plus, X5/LTS15, X7/LTS17
Semi Transparent Stain	211	311	411			Project Painter Plus, X5/LTS15, X7/LTS17
		313	413			Project Painter Plus, X5/LTS15, X7/LTS17
Solid Stain	211	311	411			Project Painter Plus, X5/LTS15, X7/LTS17
		313	413			Project Painter Plus, X5/LTS15, X7/LTS17
Interior Paint/Primer		315	415			Project Painter Plus, X5/LTS15, X7/LTS17
			417	517		X7/LTS17
Exterior Paint/Primer			415	515		Project Painter Plus, X5/LTS15, X7/LTS17
			417	517		X7/LTS17

- As you spray, the Spray Tip wears and as a result, the hole size gets larger. Starting with a Spray Tip hole size smaller than the maximum will allow you to spray longer within the compatibility of the sprayer.
- Spray Tips wear with use and need periodic replacement.

Clear Spray Tip Clog

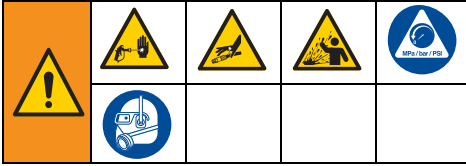

In the event that particles or debris clog the Spray Tip, the Spray Tip can be reversed to quickly and easily clear particles without disassembling the sprayer.

See **Strain the Paint**, page 16 for additional information.

1. Engage trigger lock. Rotate Spray Tip to UNCLOG position. Ensure spray tip remains fully seated, pushed all the way into the Spray Tip Guard. Disengage trigger lock. Trigger gun at waste area to clear clog.

UNCLOG



NOTE: If Spray Tip is difficult to rotate when turning to the UNCLOG position perform, **Pressure Relief Procedure**, page 14, then lower Prime/Spray Valve to SPRAY position and repeat step 1.

2. Engage trigger lock. Rotate Spray Tip back to SPRAY position. Disengage trigger lock and continue spraying.

SPRAY

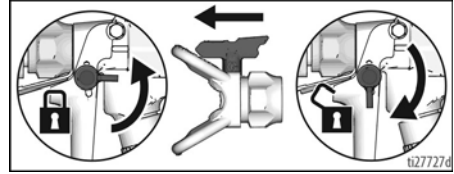

Spray Tip Installation



To prevent Spray Tip leaks make certain Spray Tip and Spray Tip Guard are installed properly.

1. Perform **Pressure Relief Procedure**, page 14.
2. Engage trigger lock.
3. Verify Spray Tip Guard parts are assembled in the order shown.

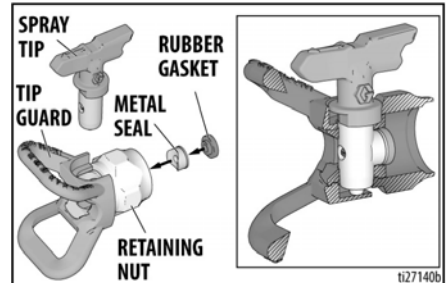

Spraying

- a. Use Spray Tip to align gasket and seal in the Spray Tip Guard.

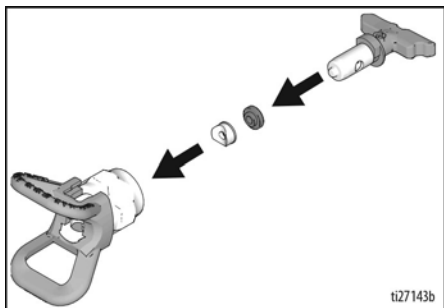

- b. Spray Tip must be pushed all the way into the Spray Tip Guard. Rotate Spray Tip while pushing down.

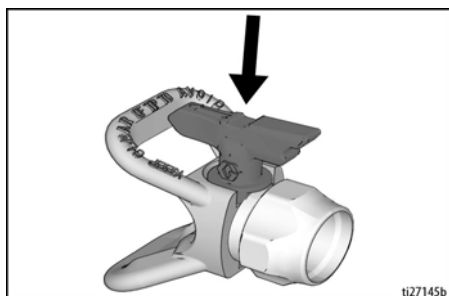

- c. Turn the arrow shaped handle on the Spray Tip forward to the SPRAY position.
4. Screw Spray Tip Guard assembly onto the gun and tighten.

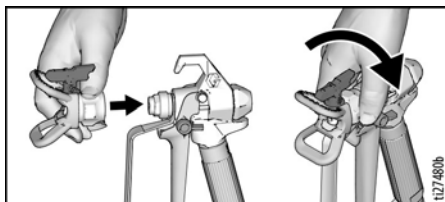

Cleanup

Cleaning the sprayer after each use results in a trouble free start up the next time the sprayer is used.

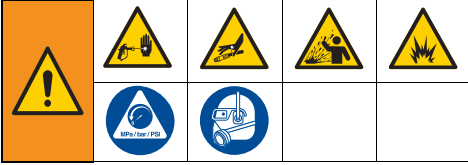

- For short term shutdown periods (overnight to two days), refer to **Short Term Storage**, page 27.
- For cleanup after using water-based materials only (by use of a garden hose), refer to **Cleanup with Power Flush Valve (Water-based materials only)**, page 25.
- For cleanup from pails, refer to **Cleaning from a Pail**, below.
- See **Cleaning Fluid Compatibility**, page 29 for information on flushing/cleaning fluids and **Static Grounding Instructions (Oil-Based Materials)**, page 29.

Cleaning from a Pail

1. Perform **Pressure Relief Procedure**, page 14.
2. Remove Spray Tip Guard assembly from gun and place in waste pail.

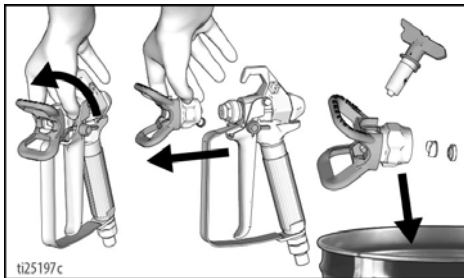

3. Lift Suction Tube and Drain Tube from paint pail. Let paint drain into the pail.
4. Separate Drain Tube (smaller) from Suction Tube (larger).

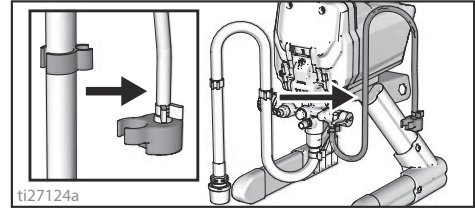

5. Place empty waste and flushing fluid pails side by side.
6. Place Suction Tube in flushing fluid. For water-based paint, use water. For oil-based paints, use mineral spirits, paint thinner, or compatible flushing fluid. Place Drain Tube in waste pail.

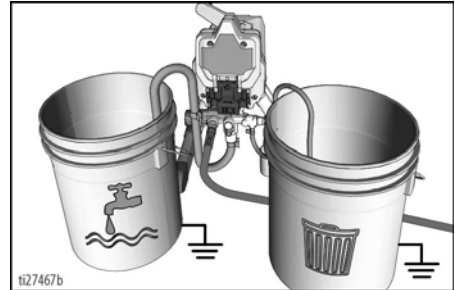

7. Turn Pressure Control Knob to the **START** position.

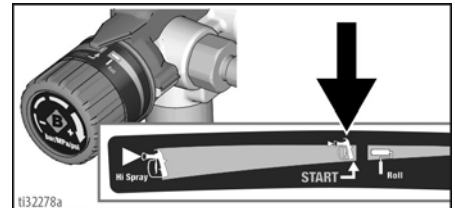

Cleanup

- Lift Prime/Spray Valve to PRIME position.

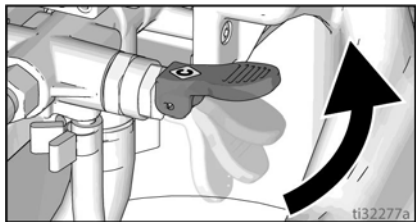

- Turn ON/OFF switch to **ON** position.
- Flush until approximately 1/3 of the flushing fluid is emptied from the pail.
- Turn ON/OFF switch to **OFF** position.

NOTE: Step 12 is for returning paint in hose to paint pail. One 25 ft (7.6 m) hose holds approximately 1/2 quart (0.5 liter) of paint.

- To recover paint in hose, point gun into paint pail while holding gun firmly to the pail.
 - Disengage trigger lock (A).
 - Pull and hold gun trigger (B).
 - Lower Prime/Spray Valve to **SPRAY** position (C).
 - Turn ON/OFF switch to **ON** position (D).

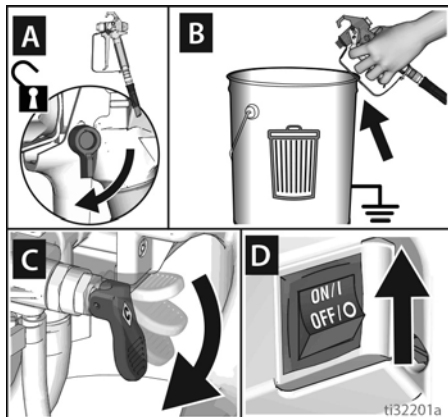

- Continue to hold gun trigger until you see paint diluted with flushing fluid starting to come out of gun.

- While continuing to trigger gun, quickly move gun to redirect spray into waste pail. Continue triggering gun into waste pail until flushing fluid dispensed from gun is relatively clear.

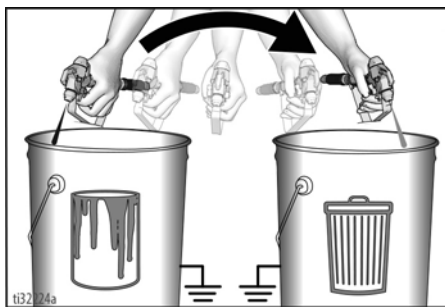

- Turn pressure control knob to the lowest setting.
- Stop triggering gun. Engage the trigger lock.

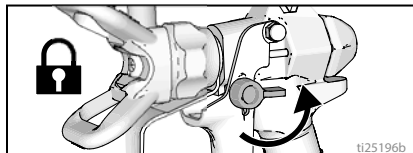

- Lift Prime/Spray Valve to PRIME position.
- Turn ON/OFF switch to **OFF** position.
- Follow **Short Term Storage** or **Long Term Storage**, page 27.

Cleanup with Power Flush Valve (Water-based materials only)

Power flushing is a faster method of cleanup. It can only be used after spraying water-based coatings.

1. Perform **Pressure Relief Procedure**, page 14.
2. Engage trigger lock. Remove Spray Tip Guard assembly from gun and place in waste pail.

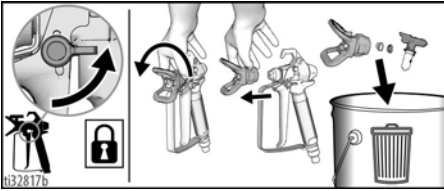

3. Place empty waste and paint pails side by side.
4. Lift Suction Tube and Drain Tube from paint pail. Let paint drain into the pail.
5. Place suction and Drain Tube in waste pail.

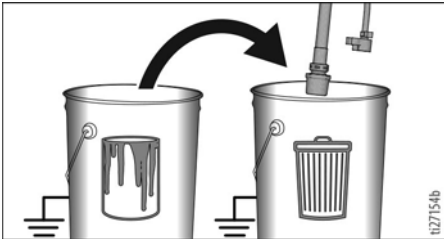

6. Turn pressure control knob to the **START** position.

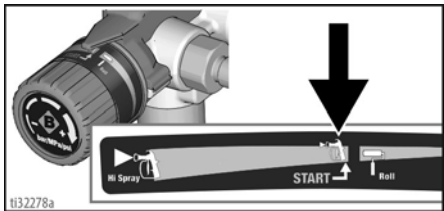

7. Screw Power Flush Valve (included with sprayer) to garden hose. Close Power Flush Valve.
8. Turn on water. Open Power Flush Valve. Rinse paint off Suction Tube, Drain Tube and inlet screen. Close Power Flush Valve.

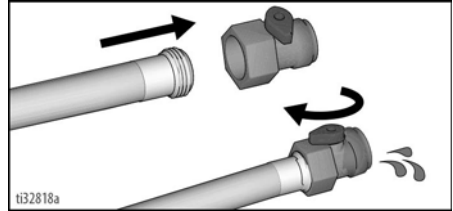

9. Unscrew inlet screen from Suction Tube. Place inlet screen in waste pail. Connect garden hose to Power Flush Valve on Suction Tube. Leave Drain Tube in waste pail.

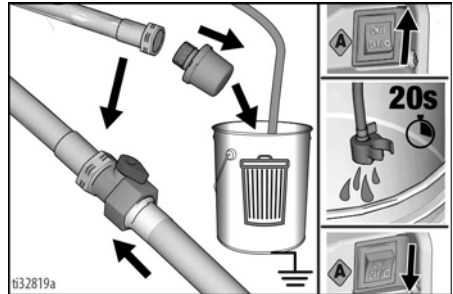

10. Turn ON/OFF switch to **ON** position.
11. Open Power Flush Valve.
12. Circulate water through sprayer, into waste pail, for 20 seconds.
13. Turn ON/OFF switch to **OFF** position.

NOTE: Step 14 is for returning paint in hose to paint pail. One 25 ft (7.6 m) hose holds approximate 1 1/2 quart (0.5 liter) of paint.

14. To recover paint in hose, point gun into paint pail while holding gun firmly to the pail.
 - a. Disengage trigger lock (A).
 - b. Pull and hold gun trigger (B).

Cleanup

- c. Lower Prime/Spray Valve to SPRAY position (C).
- d. Turn ON/OFF switch to ON position (D).
- e. Continue to hold gun trigger until you see paint diluted with flushing fluid starting to come out of gun.

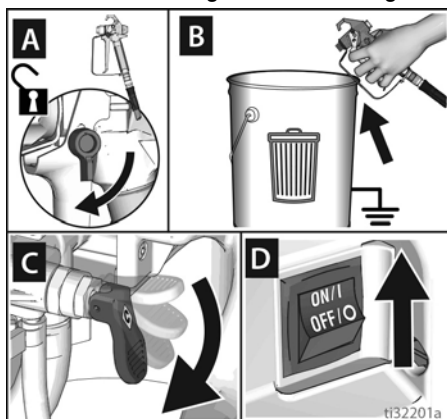

15. While continuing to trigger gun, quickly move gun to redirect spray into waste pail. Continue triggering gun into waste pail until flushing fluid dispensed from gun is relatively clear.

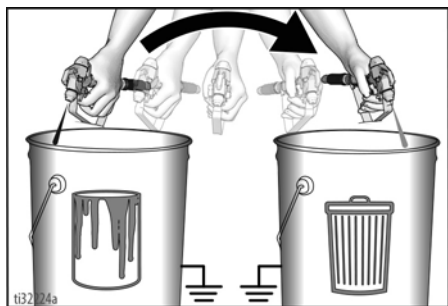

16. Turn pressure control knob to the lowest setting.
17. Stop triggering gun. Engage the trigger lock.

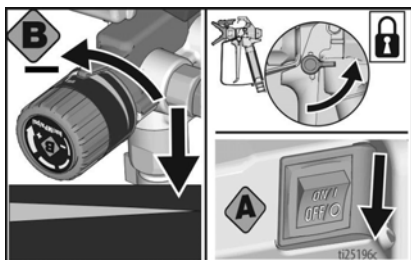

18. Lift Prime/Spray Valve to PRIME position.
19. Turn ON/OFF switch to OFF position.
20. Follow **Short Term Storage** or **Long Term Storage**, page 27.

Clean the Gun and Gun Filter

1. Perform **Pressure Relief Procedure**, page 14.
2. Remove the gun handle by unscrewing the handle from the gun head.

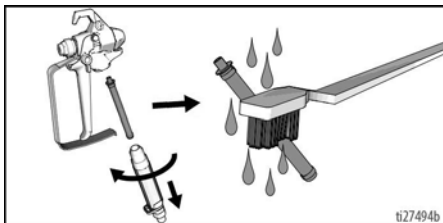

3. Clean gun filter with water or flushing fluid and a brush every time you flush the system. Replace gun filter if damaged.
4. Remove Spray Tip Guard assembly and clean with water or flushing fluid and a brush.

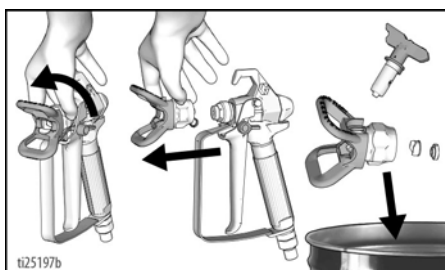

5. See **Spray Tip Installation**, page 21 to properly reinstall Spray Tip Guard assembly.
6. Wipe paint off outside of gun using a soft cloth moistened with water or flushing fluid.

Storage

With proper storage, the sprayer will be ready to use the next time it is needed.

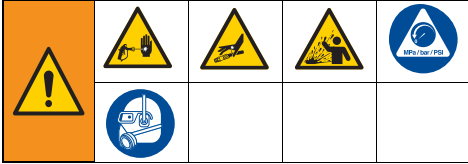

Short Term Storage

(up to 2 days)

1. Disconnect power (unplug power cord). Perform **Pressure Relief Procedure**, page 14.
2. Leave Suction Tube and Drain Tube in paint pail.

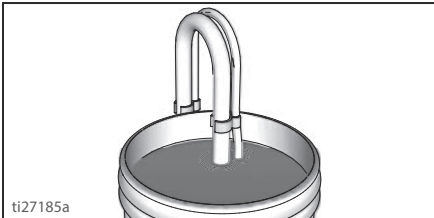

3. Cover paint and pail tightly with plastic wrap.

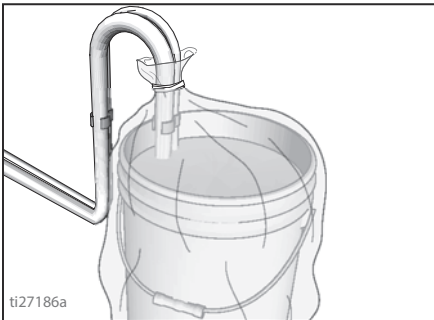

4. Engage trigger lock.

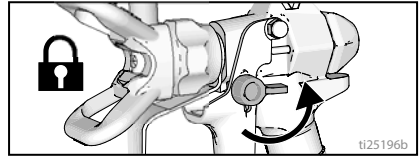

5. Leave gun attached to hose.
6. Remove Spray Tip and Spray Tip Guard and clean with water or flushing fluid and a brush.
7. Wipe paint off outside of gun using a soft cloth moistened with water or flushing fluid.

Long Term Storage

(more than 2 days)

Pump Armor™ fluid protects the sprayer against freezing and corrosion.

- Do not store the sprayer full of water.
- Do not allow water to freeze in sprayer.
- Do not store sprayer under pressure.
- Store sprayer indoors.

1. Perform **Cleanup**, page 23.
2. Remove Pump Armor bottle cap and foil seal.

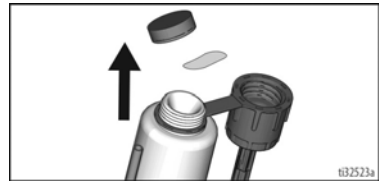

3. If needed, unscrew Inlet Screen from Suction Tube. Lift Prime/Spray Valve to PRIME position.

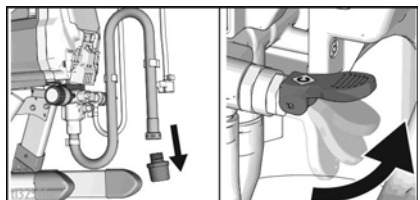

Storage

4. Place drain tube in waste pail. Turn pressure control to the **START** position.

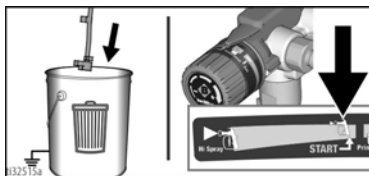

5. While holding the Suction Tube above the sprayer, pour approximately 2 ounces (1/4 cup) of Pump Armor into Suction Tube and turn Power Switch **ON**.

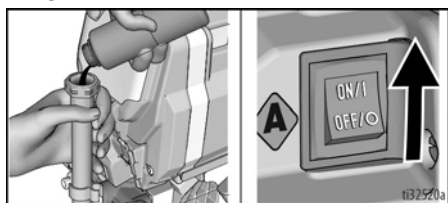

6. When Pump Armor is flushed through the sprayer and out the Drain Tube, turn Power Switch **OFF**. Replace and tighten child-proof cap for storage.

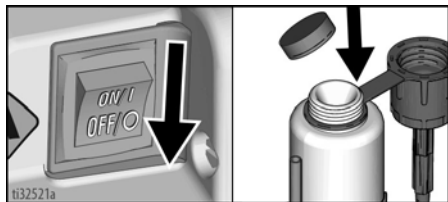

7. Screw Inlet Screen back to Suction Tube. Ensure that spray gun and hose stay attached to sprayer.

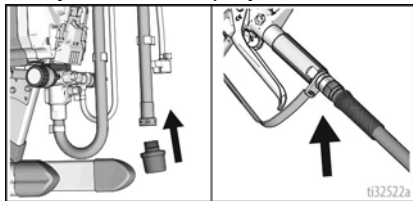

8. Lower Spray/Prime Valve to **SPRAY** position for storage.

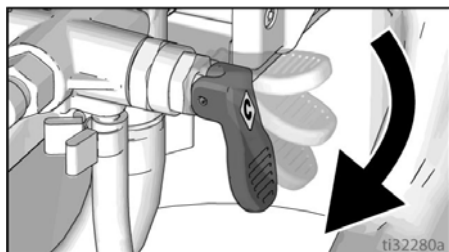

9. Turn ON/OFF switch to **OFF** position. Disconnect power (unplug power cord).
10. Secure a plastic bag around suction and Drain Tube to catch any drips.

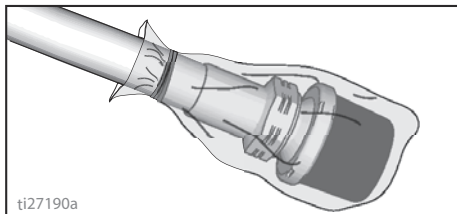

Reference

Cleaning Fluid Compatibility

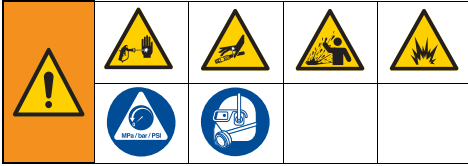

Oil- or Water-Based Materials

- When spraying **water-based** materials, flush the system thoroughly with water.
- When spraying **oil-based** materials, flush the system thoroughly with mineral spirits or compatible oil-based flushing fluid.
- To spray **water-based** materials **after spraying oil-based** materials, flush the system thoroughly with water first. The water flowing out of Drain Tube should be clear **before** you begin spraying the water-based material.
- To spray **oil-based** materials **after spraying water-based** materials, flush the system thoroughly with mineral spirits or a compatible oil-based flushing fluid first. The fluid flowing out of the Drain Tube should not contain any water. When flushing with oil-based flushing fluid always follow **Static Grounding Instructions (Oil-Based Materials)**, page 29.
- To avoid fluid splashing back on your skin or into your eyes, always aim gun at inside wall of pail.

Static Grounding Instructions (Oil-Based Materials)

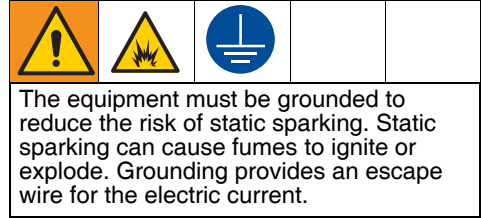

Always use a metal pail for oil-based materials when sprayer is flushed or pressure is relieved.

Follow local code. Use only conductive metal pails, placed on a grounded surface such as concrete.

Do not place pail on a non-conductive surface such as paper or cardboard which interrupts grounding continuity.

Always ground a metal pail: connect a ground wire to the pail. Clamp one end to the pail and the other end to a true earth ground such as a water pipe.

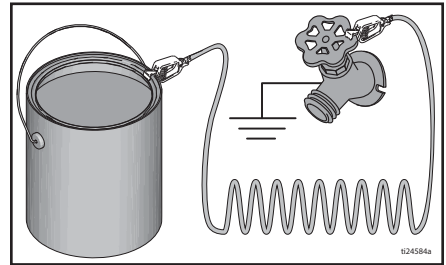





To maintain ground continuity when sprayer is flushed or pressure is relieved: hold metal part of gun firmly to the side of a grounded metal pail, then trigger the gun.



Reference

Quick Reference

Page 10	Name	Description
	Power - ON/OFF Switch	Turns sprayer ON and OFF.
	Pressure Control Knob	Increases (clockwise) and decreases (counter-clockwise) fluid pressure in pump, hose, and spray gun. To select function, align symbol on pressure control knob with setting indicator.
	Prime/Spray Valve	<ul style="list-style-type: none"> • In PRIME position directs fluid to Drain Tube. • In SPRAY position directs pressurized fluid to paint hose. • Automatically relieves system pressure in overpressure situations.
	Spray Tip	<ul style="list-style-type: none"> • Atomizes fluid being sprayed, forms spray pattern and controls fluid flow according to hole size. • Reverse position unclogs plugged Spray Tips without disassembly.
E	PushPrime™ Button	Taps the inlet ball when pushed to loosen it. Not included on Project Painter Plus.
F	Suction Tube	Draws fluid from paint pail into pump.
G	Drain Tube	Drains fluid in system during priming and pressure relief.
H	Airless Spray Gun	Dispenses fluid.
J	Spray Tip Guard	Reduces risk of fluid injection injury.
K	Gun Trigger Lock	Prevents accidental triggering of spray gun.
L	Gun Fitting	Threaded connection for paint hose.
M	Gun Filter (inside handle)	Filters fluid entering spray gun to reduce Spray Tip clogs.
N	Pump	Pumps and pressurizes fluid and delivers it to paint hose.
O	Inlet Valve	Allows paint to flow from paint bucket into the sprayer.
P	Outlet Valve (airless hose connection)	Threaded connection for airless hose. Allows paint to flow from the sprayer to the gun.
Q	Airless Hose	Transports high-pressure fluid from pump to spray gun.
S	Pail Hanger	For transporting pail by its handle.
T	Inlet Screen	Prevents debris from entering pump.
U	Power Cord	Plugs into power source.
W	Suction Tube Drip Cup	Holds the Suction Tube during transport to catch drips.
	Power Flush Valve	Connects garden hose to Suction Tube for power flushing water-based fluids.

Maintenance

Routine maintenance is important to ensure proper operation of your sprayer.



Maintenance Activity	
1.	Inspect motor shroud openings for blockage every time you spray.
2.	Clean/inspect inlet screen and gun filter every time you spray. Replace if the filter cannot be cleaned or is damaged.

NOTICE

Protect the internal drive parts of this sprayer from water. Openings in shroud allow cooling of mechanical parts and electronics inside. If water gets into these openings, the sprayer could malfunction or be permanently damaged.

Airless Hoses

Check hose for damage every time you spray. Do not attempt to repair hose if hose jacket or fittings are damaged. Do not use hoses shorter than 25 ft. (7.6 m). Wrench tighten, using two wrenches.

Spray Tips

- Always clean Spray Tips with compatible cleaning fluid and brush after spraying.
- Tips may require replacement after 15 gallons (57 liters) or they may last through 60 gallons (227 liters) depending on abrasiveness of paint. See **Spray Pattern Quality**, page 18.

Storage/Priming Tool

Perform these steps if you are experiencing difficulty priming your sprayer.

- Perform **Pressure Relief Procedure**, page 14.
- Remove Pump Armor bottle cap. Insert small fluid tube into bottom of Storage/Prime Tool, and thread tool onto the bottle. **NOTE:** For best results, make sure the bottle is full of Pump Armor.

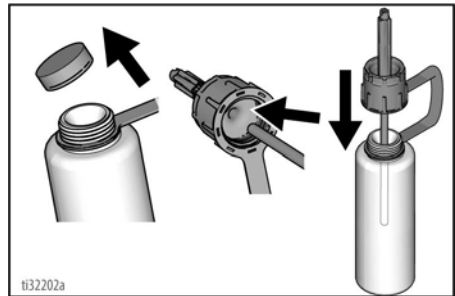

- Remove sprayer Suction Tube. Insert tool into the inlet and push up firmly until it stops.

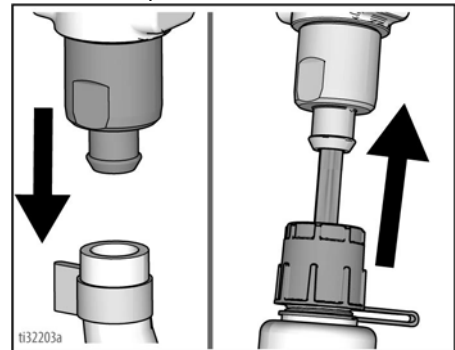

Maintenance

4. Squeeze Pump Armor bottle until Pump Armor flows into the Drain Tube.

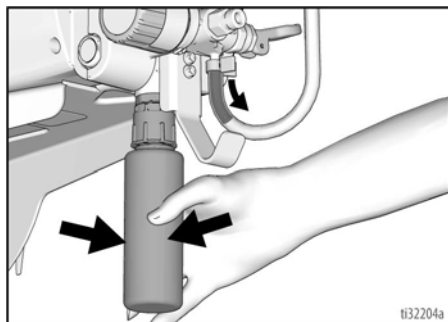

5. Remove tool. Replace and tighten child-proof cap for storage.

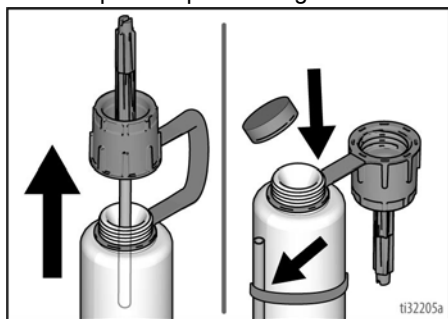

6. Reinstall the sprayer Suction Tube. Ensure that the tube is snug on the inlet and the clamp is engaged.

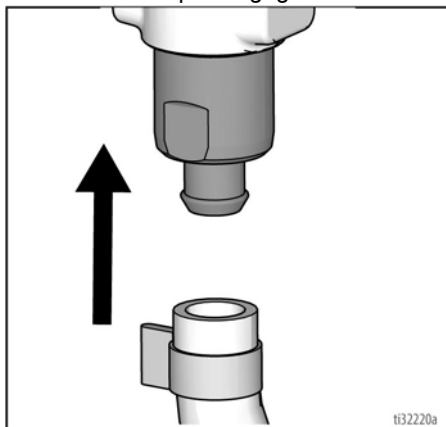

Troubleshooting

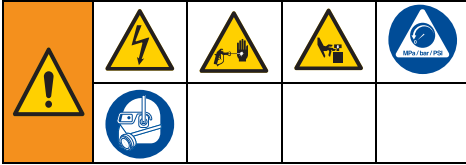

1. Follow **Pressure Relief Procedure**, page 14, before checking or repairing.
2. Solutions at the beginning of each problem listed are the most common.

3. Check everything in this Troubleshooting Table before you bring the sprayer to an authorized service center.

Have a Question?
Call Us Toll-Free: 1-888-541-9788
 or visit us at:
www.magnum.graco.com

024021a

Problem	Cause	Solution
Motor does not run: (verify sprayer is plugged in, and ON/OFF switch is on)	Pressure control is set at zero pressure.	Turn pressure control knob clockwise to increase pressure setting.
	Electric outlet is not providing power.	Test outlet with known working device. Reset circuit breaker or replace fuse. Find working outlet. Reset building circuit breaker or replace fuse.
	Extension cord is damaged.	Replace extension cord. See page 5.
	Sprayer electric cord is damaged.	Check for broken insulation or wires. Replace electric cord if damaged.
	Pump is seized (Paint has hardened in pump or Water is frozen in pump.)	Turn ON/OFF switch off and unplug sprayer from outlet. If frozen do NOT try to start sprayer until it is completely thawed or it may damage the motor, control board and/or drive train. Place sprayer in warm area for several hours. Check for free moving pump by removing shroud and spinning fan. If not frozen, check for hardened paint in pump. If paint has hardened in pump. If motor does not turn with pump removed, consult a Graco/ Magnum authorized retailer, distributor, or service center.
Motor or control is damaged.	Consult a Graco/ Magnum authorized retailer, distributor, or service center.	

Troubleshooting

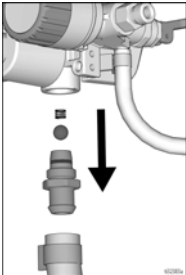
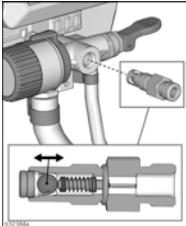
Problem	Cause	Solution
Sprayer runs, but pump does not prime or loses prime while in use. (Pump cycles but does not pull paint into Suction Tube or build pressure.)	Prime/Spray Valve is in SPRAY position.	Turn Prime/Spray Valve down to PRIME position until paint exits Drain Tube.
	Inlet screen is clogged or Suction Tube is not completely immersed in paint.	Clean debris off inlet screen and make sure Suction Tube is completely immersed in paint.
	Inlet or outlet valve ball is stuck or dirty.	<p>X5/X7 Only: Press PushPrime button twice to loosen inlet valve and reprime sprayer. See Fill Pump (Prime Pump), page 16.</p> <p>See Storage/Priming Tool, page 31. Then reprime pump.</p> <p>Remove inlet and/or outlet valves and clean and clean, replace and reprime. See Fill Pump (Prime Pump), page 16. See figures below:</p> <ul style="list-style-type: none"> • Make certain to not lose the ball and spring of the inlet valve assembly or the sprayer will not function.  <ul style="list-style-type: none"> • Make certain the outlet ball moves free in the housing before replacing. 
	Suction Tube is leaking.	Inspect Suction Tube connection for cracks or vacuum leaks.
	Debris in paint causing obstruction.	Strain the paint. See Strain the Paint , page 16.
	Prime/Spray Valve is worn or obstructed with debris.	Take sprayer to Graco/MAGNUM authorized service center.

Problem	Cause	Solution
Pump is primed, but can not achieve good spray pattern.	Spray Tip may be partially clogged.	See Clear Spray Tip Clog , page 21.
	Reversible Spray Tip is in UNCLOG position.	Rotate arrow-shaped handle on Spray Tip so it points forward to SPRAY position. See page 21.
	Debris in paint causing obstruction.	Strain the paint. See Clear Spray Tip Clog , page 21.
	Pressure is set too low.	Align pressure control knob setting indicator to desired spray setting. See Clear Spray Tip Clog , page 21.
	Spray gun filter is clogged.	Clean or replace gun filter. See Clear Spray Tip Clog , page 21.
	Spray Tip selected is too large for capability of sprayer.	Replace Spray Tip. See Spray Techniques , page 19.
	Spray Tip is worn beyond the capability of sprayer.	Replace Spray Tip. See Spray Techniques , page 19.
	Spray Tip gasket and seal worn or missing.	Replace gasket and seal. See Spray Techniques , page 19.
	Inlet screen is clogged or Suction Tube is not immersed in paint.	Clean debris off inlet screen and make sure Suction Tube is immersed in paint.
	Extension cord is too long or not heavy enough gauge.	Replace extension cord.
	Inlet valve or outlet valve is worn or clogged with debris.	Check for worn or contaminated inlet valve or outlet valve. <ul style="list-style-type: none"> - Prime sprayer with paint - Trigger gun momentarily - When trigger is released, pump should cycle momentarily and stop - If pump continues to cycle, pump valves may be worn or contaminated with debris - See Storage/Priming Tool, page 31.
	Material is too thick.	Thin material. Follow manufacturers recommendations.
Airless hose is too long (if extra section was added).	Remove section of airless hose.	
Spray gun stopped spraying while trigger is pulled.	Spray Tip is clogged.	See Clear Spray Tip Clog , page 21
	Sprayer lost prime.	Reprime sprayer. See Fill Pump (Prime Pump) , page 16.
		See Troubleshooting , page 33.

Troubleshooting

Problem	Cause	Solution
When paint is sprayed, it runs down the wall or sags.	Material is going on too thick.	Move gun faster.
		Choose a Spray Tip with smaller hole size.
		Choose Spray Tip with wider fan.
		Make sure gun is far enough from surface.
When paint is sprayed, coverage is inadequate.	Material is going on too thin.	Move gun slower.
		Choose Spray Tip with larger hole size.
		Choose Spray Tip with narrower fan.
		Make sure gun is close enough to surface.
Fan pattern varies dramatically while spraying.	Pressure control switch is worn and causing excessive pressure variation.	Take sprayer to Graco/MAGNUM authorized service center.
Cannot trigger spray gun.	Spray gun trigger lock is engaged.	Rotate trigger lock to disengage trigger lock.
Paint is coming out of pressure control switch.	Pressure control switch is worn.	Take sprayer to Graco/MAGNUM authorized service center.
Paint is leaking through Drain Tube.	Sprayer is over pressurizing.	Take sprayer to Graco/MAGNUM authorized service center.
Paint leaks down outside of pump.	Pump is worn.	Replace pump.
Motor is hot and runs intermittently. Motor automatically shuts off due to excessive heat. Damage can occur if cause is not corrected.	Vent holes in enclosure are plugged or sprayer is covered.	Keep vent holes clear of obstructions and overspray and keep sprayer open to air.
	Extension cord is too long or not a heavy enough gauge.	Replace extension cord.
	Unregulated electrical generator being used has excessive voltage.	Use electrical generator with a proper voltage regulator.
	Motor needs to be replaced.	Take sprayer to Graco/Magnum authorized retailer, distributor, or service center.

Online Resources

Visit Our Website:	magnum.graco.com
Operational Videos:	magnum.graco.com/magop/
Manuals:	magnum.graco.com/support/#manuals
Parts Online:	magnum.graco.com/partsonline/
Material Compatibility:	magnum.graco.com/downloads/MaterialCompatibility.pdf

Technical Specifications

	US	Metric
Sprayer		
Maximum fluid working pressure		
Project Painter Plus	2800 psi	193 bar, 19.3 MPa
X5 or LTS15 and X7 or LTS17	3000 psi	207 bar, 20.7 MPa
Maximum Delivery		
Project Painter Plus	0.24 gpm	0.91 lpm
X5 or LTS15	0.27 gpm	1.0 lpm
X7 or LTS17	0.31 gpm	1.2 lpm
Maximum Spray Tip Size		
Project Painter Plus, X5, LTS15	0.015 in.	0.38 mm
X7 or LTS17	0.017 in.	0.43 mm
Fluid Outlet npsm	1/4 in.	1/4 in.
Generator Minimum	2500 W	
Power Requirements	110–120V, 9 A, 1Ø	
Dimensions		
Height		
Project Painter Plus	13.8 in.	35.1 cm
X5 or LTS15	17.9 in.	45.5 cm
X7 or LTS17	37.0 in.	94.0 cm
Length		
Project Painter Plus	13.8 in.	35.1 cm
X5 or LTS15	14.5 in.	36.8 cm
X7 or LTS17	19.3 in.	49.0 cm
Width		
Project Painter Plus	12.1 in.	30.7 cm
X5 or LTS15	12.4 in.	31.5 cm
X7 or LTS17	15.3 in.	38.9 cm
Weight		
Project Painter Plus	13.2 lb.	5.9 kg
X5 or LTS15	16.5 lb.	7.5 kg
X7 or LTS17	26.5 lb.	12.0 kg
Storage temperature range ♦❖	–30° to 160°F	–35° to 71°C
Operating temperature range ✓	40° to 115°F	4° to 46°C
Materials of Construction		
Wetted materials on all models	stainless steel, brass, leather, ultra-high molecular weight polyethylene (UHMWPE), carbide, nylon, aluminum, PVC, polypropylene, fluoroelastomer, plated steel	
Notes		
* Startup pressures and displacement per cycle may vary based on suction condition, discharge head, air pressure, and fluid type.		

♦ When pump is stored with non-freezing fluid, pump damage will occur if water or latex paint freezes in pump.

❖ Damage to plastic parts may result if impact occurs in low temperature conditions.

✓ Changes in paint viscosity at very low or very high temperatures can affect sprayer performance.

Graco Standard Warranty

Graco Standard Warranty

Graco warrants all equipment referenced in this document which is manufactured by Graco and bearing its name to be free from defects in material and workmanship on the date of sale to the original purchaser for use. With the exception of any special, extended, or limited warranty published by Graco, Graco will, for a period of twelve months from the date of sale, repair or replace any part of the equipment determined by Graco to be defective. This warranty applies only when the equipment is installed, operated and maintained in accordance with Graco's written recommendations.

This warranty does not cover, and Graco shall not be liable for general wear and tear, or any malfunction, damage or wear caused by faulty installation, misapplication, abrasion, corrosion, inadequate or improper maintenance, negligence, accident, tampering, or substitution of non-Graco component parts. Nor shall Graco be liable for malfunction, damage or wear caused by the incompatibility of equipment with structures, accessories, equipment or materials not supplied by Graco, or the improper design, manufacture, installation, operation or maintenance of structures, accessories, equipment or materials not supplied by Graco.

This warranty is conditioned upon the prepaid return of the equipment claimed to be defective to an authorized Graco distributor for verification of the claimed defect. If the claimed defect is verified, Graco will repair or replace free of charge any defective parts. The equipment will be returned to the original purchaser transportation prepaid. If inspection of the equipment does not disclose any defect in material or workmanship, repairs will be made at a reasonable charge, which charges may include the costs of parts, labor, and transportation.

THIS WARRANTY IS EXCLUSIVE, AND IS IN LIEU OF ANY OTHER WARRANTIES, EXPRESS OR IMPLIED, INCLUDING BUT NOT LIMITED TO WARRANTY OF MERCHANTABILITY OR WARRANTY OF FITNESS FOR A PARTICULAR PURPOSE.

Graco's sole obligation and buyer's sole remedy for any breach of warranty shall be as set forth above. The buyer agrees that no other remedy (including, but not limited to, incidental or consequential damages for lost profits, lost sales, injury to person or property, or any other incidental or consequential loss) shall be available. Any action for breach of warranty must be brought within two (2) years of the date of sale.

GRACO MAKES NO WARRANTY, AND DISCLAIMS ALL IMPLIED WARRANTIES OF MERCHANTABILITY AND FITNESS FOR A PARTICULAR PURPOSE, IN CONNECTION WITH ACCESSORIES, EQUIPMENT, MATERIALS OR COMPONENTS SOLD BUT NOT MANUFACTURED BY GRACO. These items sold, but not manufactured by Graco (such as electric motors, switches, hose, etc.), are subject to the warranty, if any, of their manufacturer. Graco will provide purchaser with reasonable assistance in making any claim for breach of these warranties.

In no event will Graco be liable for indirect, incidental, special or consequential damages resulting from Graco supplying equipment hereunder, or the furnishing, performance, or use of any products or other goods sold hereto, whether due to a breach of contract, breach of warranty, the negligence of Graco, or otherwise.

FOR GRACO CANADA CUSTOMERS

The Parties acknowledge that they have required that the present document, as well as all documents, notices and legal proceedings entered into, given or instituted pursuant hereto or relating directly or indirectly hereto, be drawn up in English. Les parties reconnaissent avoir convenu que la rédaction du présente document sera en Anglais, ainsi que tous documents, avis et procédures judiciaires exécutés, donnés ou intentés, à la suite de ou en rapport, directement ou indirectement, avec les procédures concernées.

Graco Information

For the latest information about Graco products, visit www.graco.com.

For patent information, see www.graco.com/patents.

TO PLACE AN ORDER, contact your Graco distributor or call 1-800-690-2894 to identify the nearest distributor.

0277586



**Every Graco purchase comes
with A+ Customer Service.**

**Call: (888) 541-9788 or go to
magnum.graco.com for videos
and product information.**

PROVEN QUALITY. LEADING TECHNOLOGY.

All written and visual data contained in this document reflects the latest product information available at the time of publication.

Graco reserves the right to make changes at any time without notice.

Original instructions. This manual contains English. MM 3A6430

Graco Headquarters: Minneapolis
International Offices: Belgium, China, Japan, Korea

GRACO INC. AND SUBSIDIARIES • P.O. BOX 1441 • MINNEAPOLIS MN 55440-1441 • USA

Copyright 2017, Graco Inc. All Graco manufacturing locations are registered to ISO 9001.

www.graco.com
Revision C, June 2019