

# Instructions



## Pro Xpc™ Auto Controller Main Board

## Replacement

3A5188A  
EN

For controlling the Graco Pro Xpc Auto Electrostatic Spray Guns. For professional use only.  
Models 17H286, 17H661  
Not approved for use in explosive atmospheres or hazardous locations.



### Important Safety Instructions

For complete warnings and safety instructions see Pro Xpc™ Auto related manuals. **Save these instructions.**

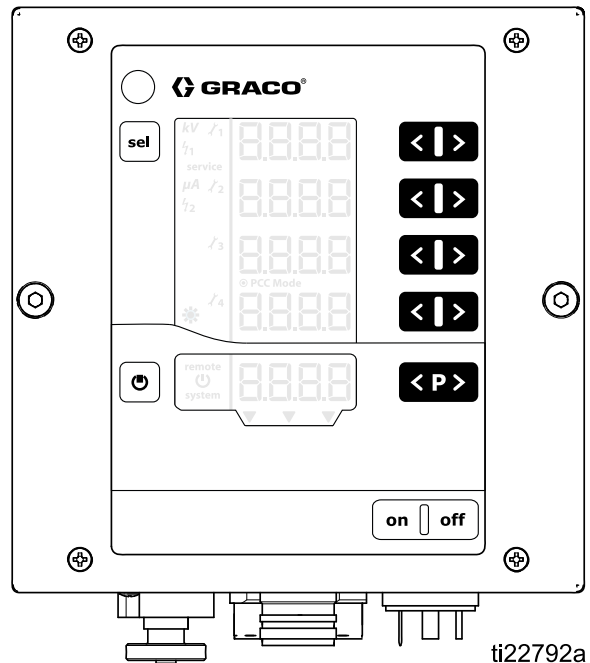

# Contents

Models.....	2	Tools Required .....	4
Related Manuals .....	2	Prepare System .....	4
Warnings .....	3	Board Replacement .....	4
Repair.....	4	Notes .....	7
Grounding .....	4	Graco Standard Warranty.....	8

# Models





Kit	Controller	Description	Maximum Gun Voltage Output at Applicator
17H287	24Y307	Pro Xpc Auto, solventborne	100 kV
17H661	24Y308	Pro Xpc Auto, waterborne	60 kV

# Related Manuals





Manual No.	Description
332992	Pro Xpc Auto Electrostatic Air Spray Gun
333266	Pro Xpc Auto Controller

# Warnings

The following warnings are for the setup, use, grounding, maintenance, and repair of this equipment. The exclamation point symbol alerts you to a general warning and the hazard symbols refer to procedure-specific risks. When these symbols appear in the body of this manual or on warning labels, refer back to these Warnings. Product-specific hazard symbols and warnings not covered in this section may appear throughout the body of this manual where applicable.





 <h2 style="margin: 0;">WARNING</h2>	
 	<p><b>ELECTRIC SHOCK HAZARD</b> This equipment must be grounded. Improper grounding, setup, or usage of the system can cause electric shock.</p> <ul style="list-style-type: none"> <li>• Turn off and disconnect power at main switch before disconnecting any cables and before servicing or installing equipment.</li> <li>• Connect only to grounded power source.</li> <li>• All electrical wiring must be done by a qualified electrician and comply with all local codes and regulations.</li> </ul>
 	<p><b>EQUIPMENT MISUSE HAZARD</b> Misuse can cause death or serious injury.</p> <ul style="list-style-type: none"> <li>• Do not operate the unit when fatigued or under the influence of drugs or alcohol.</li> <li>• Do not exceed the maximum working pressure or temperature rating of the lowest rated system component. See <b>Technical Data</b> in all equipment manuals.</li> <li>• Use fluids and solvents that are compatible with equipment wetted parts. See <b>Technical Data</b> in all equipment manuals. Read fluid and solvent manufacturer's warnings. For complete information about your material, request the Safety Data Sheet (SDS) from distributor or retailer.</li> <li>• Turn off all equipment and follow the <b>Pressure Relief Procedure</b> when equipment is not in use.</li> <li>• Check equipment daily. Repair or replace worn or damaged parts immediately with genuine manufacturer's replacement parts only.</li> <li>• Do not alter or modify equipment. Alterations or modifications may void agency approvals and create safety hazards.</li> <li>• Make sure all equipment is rated and approved for the environment in which you are using it.</li> <li>• Use equipment only for its intended purpose. Call your distributor for information.</li> <li>• Route hoses and cables away from traffic areas, sharp edges, moving parts, and hot surfaces.</li> <li>• Do not kink or over bend hoses or use hoses to pull equipment.</li> <li>• Keep children and animals away from work location.</li> <li>• Comply with all applicable safety regulations.</li> </ul>

# Repair

				
<p>To avoid electric shock, turn off equipment power and shut off power at main circuit breaker before installing.</p>				

<b>NOTICE</b>
<p>To avoid damaging the circuit boards when servicing the control box, wear Part No. 112190 grounding strap on your wrist and ground appropriately each time.</p>

## Grounding

				
<p>The equipment must be grounded. Grounding reduces the risk of static shock by providing an escape path for the electrical current due to static build up or in the event of a short circuit.</p>				

## Tools Required

- Phillips head screwdriver
- Small flat head screwdriver
- 5.5 mm (7/32") socket
- Grounding strap and ground connection
- 4 mm (1/8") Allen wrench if controller uses mounting bracket

## Prepare System

1. Record the settings on your existing controller. These can be logged by using an SD Card and setting the Log Level to at least 1.

Setting	Values
P02	0: Off, 1: Discrete I/O, 2: CAN
P03	0: Voltage, 1: Current
P04	0: Voltage, 1: Current
P06	0-32
P07	0-5
C0	0.01-1.00
C1	0.0-2.0
C2	0.0-60.0
C3	0.0-5.0
Used Presets	kV, uA, Static Arc, Dynamic Arc

2. Remove power from the controller. Follow appropriate lock-out/tag-out procedures.
3. Follow instructions for wrist strap installation in manual 3A1791.

## Board Replacement

1. Remove all outside connections from the controller.
2. Remove the controller from its mounting surface or bracket using the 4 mm (1/8") Allen wrench (service is best accomplished if the controller is on a workbench).

3. Using the Phillips head screwdriver, loosen the 4 screws holding the front access cover in place and carefully remove the front access cover.

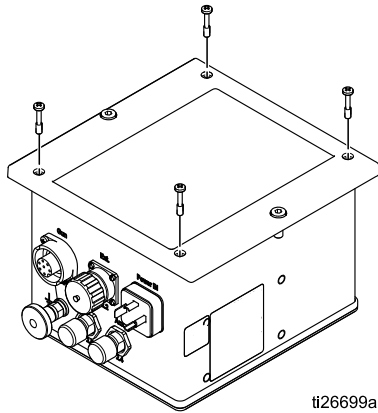

4. Remove connections on the main board.
  - a. Remove the 3 green connectors (G) by hand. Gently wiggle the connectors from side to side to loosen and remove.
  - b. Unlock the 3 black connectors (B) using a flat head screwdriver. Gently wiggle the connectors from side to side to loosen and remove by hand.
  - c. Remove the strain relief band from the 2 white ribbon cables (W). Unlock the ribbon cables by gently wiggling the top of the connector upwards until it snaps out of position (the connector stays on the board). Then gently pull the ribbon cable out of the connector.

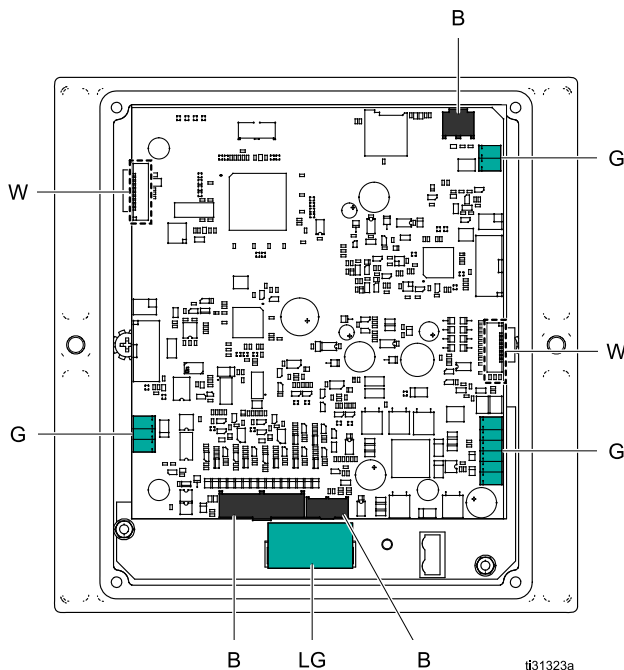

5. For easier service, remove the cable connections to the power board (PB) and power supply board (PS) (the power supply is in the controller housing).

- a. Remove the large green connector (LG) on the power board. This is mounted below the main board. Gently wiggle the connector from side to side to loosen and remove by hand.
- b. Remove the white connector (WC) from inside the controller housing that goes to the power supply. Gently wiggle the connector from side to side to loosen and remove by hand.

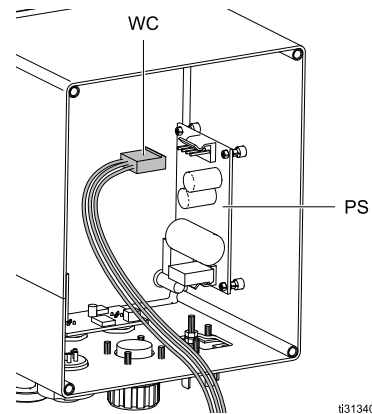

6. The main board is held in place by 4 acorn nuts (AC) and 4 washers. Using the 5 mm (7/32") socket, remove the nuts and washers and carefully lift the board off of the standoffs.

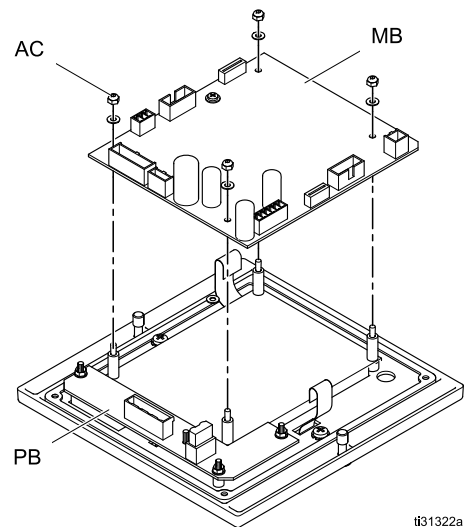

## Repair

7. Remove the replacement board from the packaging. Orient it properly and place it onto the standoffs.
8. Replace the washers and acorn nuts (AC) on each standoff. Tighten by hand.
9. If removed, replace the 2 additional cable connections to the power board (PB) and power supply board (PS).
  - a. Replace the large green (LG) connector on the power board. This is mounted below the main board (MB). Note the keying features and push into place by hand.
  - b. Replace the white connector (WC) on the power supply board. This is mounted on the inside of the controller housing. Note the keying features and push into place by hand.
10. Replace connections on the main board.
  - a. Replace the 3 main board green connections (G). Note the keying features and push into place by hand.
  - b. Replace the 3 main board black connections (B). Note the keying features and push into place by hand.
  - c. Replace the 2 main board white ribbon connections (W). Make sure the top of the connector is loose by gently pulling upwards on the connector. Push the ribbon cable into the connector until it bottoms out. Push the top of the connector down onto the board until it locks. Replace the strain relief band over the ribbon cable and connector. Verify the ribbon cable is locked in place by gently pulling on it.
11. When all connections are made, gently replace the front access cover on the connector housing. Make sure that no cables are pinched in the process.
12. Using the Phillips head screwdriver, tighten the 4 screws holding the front access cover in place.
13. Replace the outside connections to the controller. Connect power, turn on, and reload settings before returning to service.



# Graco Standard Warranty

Graco warrants all equipment referenced in this document which is manufactured by Graco and bearing its name to be free from defects in material and workmanship on the date of sale to the original purchaser for use. With the exception of any special, extended, or limited warranty published by Graco, Graco will, for a period of twelve months from the date of sale, repair or replace any part of the equipment determined by Graco to be defective. This warranty applies only when the equipment is installed, operated and maintained in accordance with Graco's written recommendations.

This warranty does not cover, and Graco shall not be liable for general wear and tear, or any malfunction, damage or wear caused by faulty installation, misapplication, abrasion, corrosion, inadequate or improper maintenance, negligence, accident, tampering, or substitution of non-Graco component parts. Nor shall Graco be liable for malfunction, damage or wear caused by the incompatibility of Graco equipment with structures, accessories, equipment or materials not supplied by Graco, or the improper design, manufacture, installation, operation or maintenance of structures, accessories, equipment or materials not supplied by Graco.

This warranty is conditioned upon the prepaid return of the equipment claimed to be defective to an authorized Graco distributor for verification of the claimed defect. If the claimed defect is verified, Graco will repair or replace free of charge any defective parts. The equipment will be returned to the original purchaser transportation prepaid. If inspection of the equipment does not disclose any defect in material or workmanship, repairs will be made at a reasonable charge, which charges may include the costs of parts, labor, and transportation.

**THIS WARRANTY IS EXCLUSIVE, AND IS IN LIEU OF ANY OTHER WARRANTIES, EXPRESS OR IMPLIED, INCLUDING BUT NOT LIMITED TO WARRANTY OF MERCHANTABILITY OR WARRANTY OF FITNESS FOR A PARTICULAR PURPOSE.**

Graco's sole obligation and buyer's sole remedy for any breach of warranty shall be as set forth above. The buyer agrees that no other remedy (including, but not limited to, incidental or consequential damages for lost profits, lost sales, injury to person or property, or any other incidental or consequential loss) shall be available. Any action for breach of warranty must be brought within two (2) years of the date of sale.

**GRACO MAKES NO WARRANTY, AND DISCLAIMS ALL IMPLIED WARRANTIES OF MERCHANTABILITY AND FITNESS FOR A PARTICULAR PURPOSE, IN CONNECTION WITH ACCESSORIES, EQUIPMENT, MATERIALS OR COMPONENTS SOLD BUT NOT MANUFACTURED BY GRACO.** These items sold, but not manufactured by Graco (such as electric motors, switches, hose, etc.), are subject to the warranty, if any, of their manufacturer. Graco will provide purchaser with reasonable assistance in making any claim for breach of these warranties.

In no event will Graco be liable for indirect, incidental, special or consequential damages resulting from Graco supplying equipment hereunder, or the furnishing, performance, or use of any products or other goods sold hereto, whether due to a breach of contract, breach of warranty, the negligence of Graco, or otherwise.

## FOR GRACO CANADA CUSTOMERS

The Parties acknowledge that they have required that the present document, as well as all documents, notices and legal proceedings entered into, given or instituted pursuant hereto or relating directly or indirectly hereto, be drawn up in English. Les parties reconnaissent avoir convenu que la rédaction du présente document sera en Anglais, ainsi que tous documents, avis et procédures judiciaires exécutés, donnés ou intentés, à la suite de ou en rapport, directement ou indirectement, avec les procédures concernées.

## Graco Information

For the latest information about Graco products, visit [www.graco.com](http://www.graco.com). For patent information, see [www.graco.com/patents](http://www.graco.com/patents).

**To place an order**, contact your Graco Distributor or call to identify the nearest distributor.  
**Phone:** 612-623-6921 or **Toll Free:** 1-800-328-0211 **Fax:** 612-378-3505

All written and visual data contained in this document reflects the latest product information available at the time of publication.

Graco reserves the right to make changes at any time without notice.

Original Instructions. This manual contains English, MM 333266

**Graco Headquarters:** Minneapolis  
**International Offices:** Belgium, China, Japan, Korea

**GRACO INC. AND SUBSIDIARIES • P.O. BOX 1441 • MINNEAPOLIS, MN 55440-1441 • USA**

**Copyright 2015, Graco Inc. All Graco manufacturing locations are registered to ISO 9001.**

[www.graco.com](http://www.graco.com)  
Revision A, April 2017