

## ProMix® PD2K Integrated for Automatic Spray Applications

3A4128D  
EN

Electronic positive displacement proportioner integrated with air controls and electrostatics for fast-setting two-component materials. Automatic system with Advanced Display Module. For professional use only.



### Important Safety Instructions

Read all warnings and instructions in this manual and in your installation, repair, and associated component manuals. **Save these instructions.**

*See page 4 for model part numbers and approvals information.*

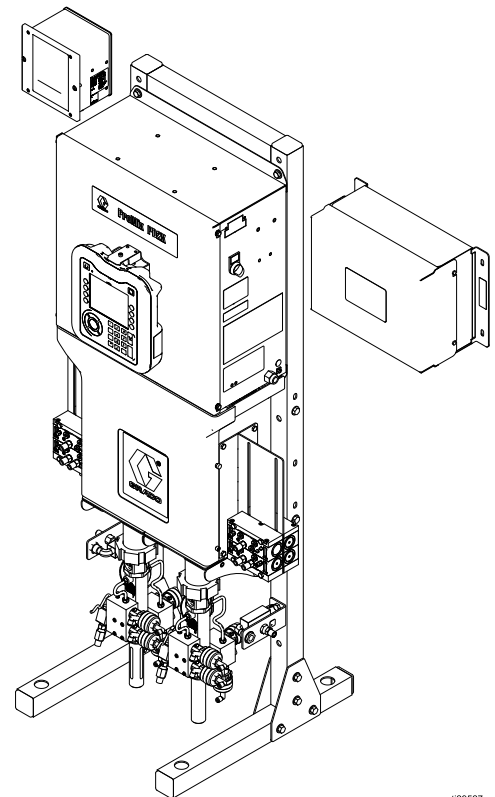

t29527a

# Contents

Related Manuals .....	3	Jobs Screen .....	95
Models .....	4	Errors Screen .....	95
Positive Displacement Proportioner .....	4	Events Screen .....	95
Integrated Air Control .....	4	Setup Mode Screens .....	96
Speed Controller .....	4	Password Screen .....	96
Pro Xpc Auto Electrostatic Controller .....	5	System Screen 1 .....	96
ProBell Electrostatic Controller .....	5	System Screen 2 .....	97
Warnings .....	6	Solvent Push Configuration .....	99
Important Isocyanate (ISO) Information .....	9	Solvent Push Operation .....	100
General Information .....	11	System Screen 3 .....	101
Advanced Display Module (ADM) .....	12	System Screen 4 .....	102
ADM Display .....	12	System Screen 5 .....	102
USB Upload Procedure .....	12	Recipe Screen .....	104
ADM Keys and Indicators .....	13	Flush Screen .....	106
Soft Key Icons .....	14	Preset Screen .....	108
Navigating the Screens .....	20	Pump Screen 1: Pump Definitions .....	109
Screen Icons .....	20	Pump Screen 2: Transducer Settings .....	111
USB Download Procedure .....	21	Pump Screen 3: Pressure Alarms .....	112
Pre-Operation Tasks .....	22	Pump Screen 4: Advanced Configuration .....	112
Pre-operation Checklist .....	22	Pump Screen 5, Valve Assignment .....	115
Power On .....	24	Gun Screen 1 .....	118
Initial System Setup .....	24	Gun Screen 2 .....	120
Flush Before Using Equipment .....	24	Gun Screen 3 .....	121
Valve Settings .....	24	Gun Screen 4 .....	122
Pressure Relief Procedure .....	25	Gateway Screens .....	123
Without Color Change .....	25	Calibration Screens .....	126
With Color Change .....	25	Maintenance Screens .....	129
Operation Using Advanced Display Module (ADM) .....	26	Advanced Screen 1 .....	132
Prime and Fill the System .....	26	Advanced Screen 2 .....	133
Spraying .....	26	Advanced Screen 3 .....	133
Purging .....	27	Advanced Screen 4 .....	134
Shutdown .....	28	Advanced Screen 5 .....	134
Operation Using a Programmable Logic Controller (PLC) .....	29	Diagnostic Screens .....	135
Network Communications and Discrete I/O .....	29	Calibration Checks .....	136
Discrete I/O .....	29	Pump Pressure Check .....	136
Communication Gateway Module (CGM) Details .....	33	Pump Volume Check .....	137
Network Communication I/O Data Map .....	34	Solvent Meter Calibration .....	138
Operation Flow Charts .....	54	Color Change .....	139
Network Communication - Dynamic Command Structure (DCS) .....	63	Multiple Color Systems .....	139
PLC Diagnostic Screens .....	80	System Errors .....	140
Flow Control System .....	81	To Clear Error and Restart .....	140
Run Mode Screens .....	82	Gun Trigger Input Function .....	140
Opening Screen .....	82	Error Codes .....	141
Home Screen .....	82	Maintenance .....	167
Spray Screen .....	85	Preventive Maintenance Schedule .....	167
Gun Screen .....	87	Flushing .....	167
Gun Status Screen .....	91	Cleaning the ADM .....	167
Fill Screen .....	93	Appendix A: Integration with Allen Bradley PLC .....	168
Potlife Screen .....	94	Appendix B: Multiple Guns .....	171
Usage Screen .....	94	Technical Specifications .....	176
		California Proposition 65 .....	179
		Graco Standard Warranty .....	180

## Related Manuals

Current manuals are available at [www.graco.com](http://www.graco.com).

Manual No.	Description
332709	ProMix PD2K Proportioner for Automatic Spray Applications, Repair — Parts
332458	ProMix PD2K Proportioner for Automatic Spray Applications, Installation
332564	ProMix PD2K Proportioner for Automatic Spray Applications, Operation
332339	Dosing Pumps, Instructions — Parts
332454	Color/Catalyst Dispense Valves, Instructions — Parts
333282	Color Change and Remote Mix Manifold Kits, Instructions — Parts
332456	Pump Expansion Kits, Instructions — Parts
334183	Modbus TCP Gateway Module, Instructions — Parts
334494	ProMix PD2K CGM Installation Kits, Instructions — Parts

Manual No.	Description
3A3465	Integrated Air Control, Instructions
3A3657	ProBell Electrostatic Controller, Instructions
3A3953	ProBell Speed Controller, Instructions
313516	Automatic AirPro Spray Guns, Instructions — Parts
311052	Automatic G40 Air-Assisted Spray Guns, Instructions — Parts
332992	Pro Xpc Auto Electrostatic Air Spray Gun, Instructions — Parts
333266	Pro Xpc Auto Controller, Instructions
313869	AirPro EFX Automatic Spray Gun, Instructions — Parts
334452	ProBell Rotary Applicator, Instructions — Parts
334626	ProBell Rotary Applicator, Hollow Wrist, Instructions — Parts

# Models

## Positive Displacement Proportioner

Part No.	Maximum Air Working Pressure	Maximum Fluid Working Pressure
AC0500	100 psi (0.7 MPa, 7.0 bar)	With low-pressure pumps: 300 psi (2.068 MPa, 20.68 bar)
		With high-pressure pumps: 1500 psi (10.34 MPa, 103.4 bar)
AC1000	100 psi (0.7 MPa, 7.0 bar)	300 psi (2.068 MPa, 20.68 bar)
AC2000	100 psi (0.7 MPa, 7.0 bar)	1500 psi (10.34 MPa, 103.4 bar)



## Integrated Air Control

Part No.	Description	Maximum Air Working Pressure
26A010	Integrated Air Controller	100 psi (0.7 MPa, 7.0 bar)



## Speed Controller

Part No.	Description	Maximum Air Working Pressure
24Z220	Speed Controller	100 psi (0.7 MPa, 7.0 bar)



### Pro Xpc Auto Electrostatic Controller

Part No.	Description	Maximum Applicator Voltage Output
24Y307	Pro Xpc Auto Controller, solventborne	100 kV



II 3(2)G T6  
PTB 15 ATEX 5013  
EN 50050-1, EN 50176



RECOGNIZED  
COMPONENT



Intertek  
9902471  
Conforms to UL STD 61010-1  
and UL STD 61010-2-201  
Cert. to CSA STD C22.2#61010-1  
and CSA/IEC STD  
61010-2-201:2014

### ProBell Electrostatic Controller

Part No.	Description	Maximum Voltage Output at Applicator
24Z098	ProBell Electrostatic Controller, solventborne	100 kV



II 3(2)G T6  
PTB 16 ATEX 5006  
EN 50176 Type B-L







RECOGNIZED  
COMPONENT



















Intertek  
9902471  
Conforms to UL STDS.  
61010-1 & 61010-2-201,  
IEC STD. 61010-2-201  
Certified to CSA STDS. C22.2  
# 61010-1 & 61010-2-201

# Warnings

The following warnings are for the setup, use, grounding, maintenance, and repair of this equipment. The exclamation point symbol alerts you to a general warning and the hazard symbols refer to procedure-specific risks. When these symbols appear in the body of this manual, refer back to these Warnings. Product-specific hazard symbols and warnings not covered in this section may appear throughout the body of this manual where applicable.

 <h2 style="margin: 0;">WARNING</h2>	
   	<p><b>FIRE AND EXPLOSION HAZARD</b></p> <p>Flammable fumes, such as solvent and paint fumes, in <b>work area</b> can ignite or explode. Paint or solvent flowing through the equipment can cause static sparking. To help prevent fire and explosion:</p> <ul style="list-style-type: none"> <li>• Use equipment only in well ventilated area.</li> <li>• Eliminate all ignition sources; such as pilot lights, cigarettes, portable electric lamps, and plastic drop cloths (potential static arc).</li> <li>• Ground all equipment in the work area. See <b>Grounding</b> instructions.</li> <li>• Never spray or flush solvent at high pressure.</li> <li>• Keep work area free of debris, including solvent, rags and gasoline.</li> <li>• Do not plug or unplug power cords, or turn power or light switches on or off when flammable fumes are present.</li> <li>• Use only grounded hoses.</li> <li>• Hold gun firmly to side of grounded pail when triggering into pail. Do not use pail liners unless they are antistatic or conductive.</li> <li>• <b>Stop operation immediately</b> if static sparking occurs or you feel a shock, Do not use equipment until you identify and correct the problem.</li> <li>• Keep a working fire extinguisher in the work area.</li> </ul>
 	<p><b>ELECTRIC SHOCK HAZARD</b></p> <p>This equipment must be grounded. Improper grounding, setup, or usage of the system can cause electric shock.</p> <ul style="list-style-type: none"> <li>• Turn off and disconnect power at main switch before disconnecting any cables and before servicing or installing equipment.</li> <li>• Connect only to grounded power source.</li> <li>• All electrical wiring must be done by a qualified electrician and comply with all local codes and regulations.</li> </ul>

 <h1 style="margin: 0;">WARNING</h1>	
  	<p><b>INTRINSIC SAFETY</b></p> <p>Intrinsically safe equipment that is installed improperly or connected to non-intrinsically safe equipment will create a hazardous condition and can cause fire, explosion, or electric shock. Follow local regulations and the following safety requirements.</p> <ul style="list-style-type: none"> <li>• Be sure your installation complies with national, state, and local codes for the installation of electrical apparatus in a Class I, Group D, Division 1 (North America) or Class I, Zones 1 and 2 (Europe) Hazardous Location, including all of the local safety fire codes (for example, NFPA 33, NEC 500 and 516, OSHA 1910.107, etc.).</li> <li>• To help prevent fire and explosion:               <ul style="list-style-type: none"> <li>• Do not install equipment approved only for a non-hazardous location in a hazardous location. See model ID label for the intrinsic safety rating of your model.</li> <li>• Do not substitute system components as this may impair intrinsic safety.</li> </ul> </li> <li>• Equipment that comes in contact with the intrinsically safe terminals must be rated for Intrinsic Safety. This includes DC voltage meters, ohmmeters, cables, and connections. Remove the unit from the hazardous area when troubleshooting.</li> </ul>
    	<p><b>SKIN INJECTION HAZARD</b></p> <p>High-pressure fluid from gun, hose leaks, or ruptured components will pierce skin. This may look like just a cut, but it is a serious injury that can result in amputation. <b>Get immediate surgical treatment.</b></p> <ul style="list-style-type: none"> <li>• Do not spray without tip guard and trigger guard installed.</li> <li>• Engage trigger lock when not spraying.</li> <li>• Do not point gun at anyone or at any part of the body.</li> <li>• Do not put your hand over the spray tip.</li> <li>• Do not stop or deflect leaks with your hand, body, glove, or rag.</li> <li>• Follow the <b>Pressure Relief Procedure</b> when you stop spraying/dispersing and before cleaning, checking, or servicing equipment.</li> <li>• Tighten all fluid connections before operating the equipment.</li> <li>• Check hoses and couplings daily. Replace worn or damaged parts immediately.</li> </ul>
 	<p><b>MOVING PARTS HAZARD</b></p> <p>Moving parts can pinch, cut or amputate fingers and other body parts.</p> <ul style="list-style-type: none"> <li>• Keep clear of moving parts.</li> <li>• Do not operate equipment with protective guards or covers removed.</li> <li>• Pressurized equipment can start without warning. Before checking, moving, or servicing equipment, follow the <b>Pressure Relief Procedure</b> and disconnect all power sources.</li> </ul>





 <h1 style="margin: 0;">WARNING</h1>	
 	<p><b>TOXIC FLUID OR FUMES</b>                      Toxic fluids or fumes can cause serious injury or death if splashed in the eyes or on skin, inhaled, or swallowed.</p> <ul style="list-style-type: none"> <li>• Read Safety Data Sheet (SDS) for handling instructions and to know the specific hazards of the fluids you are using, including the effects of long-term exposure.</li> <li>• When spraying, servicing equipment, or when in the work area, always keep work area well ventilated and always wear appropriate personal protective equipment. See <b>Personal Protective Equipment</b> warnings in this manual.</li> <li>• Store hazardous fluid in approved containers, and dispose of it according to applicable guidelines.</li> </ul>
	<p><b>PERSONAL PROTECTIVE EQUIPMENT</b>                      Always wear appropriate personal protective equipment and cover all skin when spraying, servicing equipment, or when in the work area. Protective equipment helps prevent serious injury, including long-term exposure; inhalation of toxic fumes, mists, or vapors; allergic reactions; burns; eye injury and hearing loss. This protective equipment includes, but is not limited to:</p> <ul style="list-style-type: none"> <li>• A properly fitting respirator, which may include a supplied-air respirator, chemically impermeable gloves, protective clothing and foot coverings as recommended by the fluid manufacturer and local regulatory authority.</li> <li>• Protective eyewear, and hearing protection.</li> </ul>
 	<p><b>EQUIPMENT MISUSE HAZARD</b>                      Misuse can cause death or serious injury.</p> <ul style="list-style-type: none"> <li>• Do not operate the unit when fatigued or under the influence of drugs or alcohol.</li> <li>• Do not exceed the maximum working pressure or temperature rating of the lowest rated system component. See <b>Technical Data</b> in all equipment manuals.</li> <li>• Use fluids and solvents that are compatible with equipment wetted parts. See <b>Technical Data</b> in all equipment manuals. Read fluid and solvent manufacturer's warnings. For complete information about your material, request SDS from distributor or retailer.</li> <li>• Do not leave the work area while equipment is energized or under pressure.</li> <li>• Turn off all equipment and follow the <b>Pressure Relief Procedure</b> when equipment is not in use.</li> <li>• Check equipment daily. Repair or replace worn or damaged parts immediately with genuine manufacturer's replacement parts only.</li> <li>• Do not alter or modify equipment. Alterations or modifications may void agency approvals and create safety hazards.</li> <li>• Make sure all equipment is rated and approved for the environment in which you are using it.</li> <li>• Use equipment only for its intended purpose. Call your distributor for information.</li> <li>• Route hoses and cables away from traffic areas, sharp edges, moving parts, and hot surfaces.</li> <li>• Do not kink or over bend hoses or use hoses to pull equipment.</li> <li>• Keep children and animals away from work area.</li> <li>• Comply with all applicable safety regulations.</li> </ul>



# Important Isocyanate (ISO) Information

Isocyanates (ISO) are catalysts used in two component materials.



## Isocyanate Conditions

				
<p>Spraying or dispensing fluids that contain isocyanates creates potentially harmful mists, vapors, and atomized particulates</p> <ul style="list-style-type: none"> <li>• Read and understand the fluid manufacturer's warnings and Safety Data Sheet (SDS) to know specific hazards and precautions related to isocyanates.</li> <li>• Use of isocyanates involves potentially hazardous procedures. Do not spray with the equipment unless you are trained, qualified, and have read and understood the information in this manual and in the fluid manufacturer's application instructions and SDS.</li> <li>• Use of incorrectly maintained or mis-adjusted equipment may result in improperly cured material. Equipment must be carefully maintained and adjusted according to instructions in the manual.</li> <li>• To prevent inhalation of isocyanate mists, vapors, and atomized particulates, everyone in the work area must wear appropriate respiratory protection. Always wear a properly fitting respirator, which may include a supplied-air respirator. Ventilate the work area according to instructions in the fluid manufacturer's SDS.</li> <li>• Avoid all skin contact with isocyanates. Everyone in the work area must wear chemically impermeable gloves, protective clothing and foot coverings as recommended by the fluid manufacturer and local regulatory authority. Follow all fluid manufacturer recommendations, including those regarding handling of contaminated clothing. After spraying, wash hands and face before eating or drinking.</li> </ul>				

## Material Self-ignition

				
<p>Some materials may become self-igniting if applied too thick. Read material manufacturer's warnings and Safety Data Sheet (SDS).</p>				

## Keep Components A and B Separate

				
<p>Cross-contamination can result in cured material in fluid lines which could cause serious injury or damage equipment. To prevent cross-contamination:</p> <ul style="list-style-type: none"> <li>• <b>Never</b> interchange component A and component B wetted parts.</li> <li>• Never use solvent on one side if it has been contaminated from the other side.</li> </ul>				

## Moisture Sensitivity of Isocyanates

Exposure to moisture (such as humidity) will cause ISO to partially cure; forming small, hard, abrasive crystals, which become suspended in the fluid. Eventually a film will form on the surface and the ISO will begin to gel, increasing in viscosity.

### NOTICE

Partially cured ISO will reduce performance and the life of all wetted parts.

- Always use a sealed container with a desiccant dryer in the vent, or a nitrogen atmosphere. **Never** store ISO in an open container.
- Keep the ISO pump wet cup or reservoir (if installed) filled with appropriate lubricant. The lubricant creates a barrier between the ISO and the atmosphere.
- Use only moisture-proof hoses compatible with ISO.
- Never use reclaimed solvents, which may contain moisture. Always keep solvent containers closed when not in use.
- Always lubricate threaded parts with an appropriate lubricant when reassembling.

**NOTE:** The amount of film formation and rate of crystallization varies depending on the blend of ISO, the humidity, and the temperature.

## Changing Materials

### NOTICE

Changing the material types used in your equipment requires special attention to avoid equipment damage and downtime.

- When changing materials, flush the equipment multiple times to ensure it is thoroughly clean.
- Always clean the fluid inlet strainers after flushing.
- Check with your material manufacturer for chemical compatibility.
- When changing between epoxies and urethanes or polyureas, disassemble and clean all fluid components and change hoses. Epoxies often have amines on the B (hardener) side. Polyureas often have amines on the A (resin) side.

## General Information

The PD2K Integrated System can coordinate the operation of four systems: a Positive Displacement Proportioner (models AC0500, AC1000, and AC2000), an Integrated Air Control (model 26A010), an Speed Controller (model 24Z220), and an Electrostatic Controller (model 24Y307 or 24Z098). See [Related Manuals, page 3](#) for additional information about each of the integrated systems.

- Reference numbers and letters in parentheses in the text refer to numbers and letters in the illustrations.
- The term “applicator” is used in this manual to refer to either “spray device” or “gun” where applicable.
- Be sure all accessories are adequately sized and pressure-rated to meet system requirements.
- To protect the screens from paints and solvents, clear-plastic protective shields (10 per pack) are available. Order Part No. 197902 for the Advanced Display Module. Clean the screens with a dry cloth if necessary.

# Advanced Display Module (ADM)

## ADM Display

The ADM display shows graphical and text information related to setup and spray operations.

For detail on the display and individual screens, see [Run Mode Screens, page 82](#), or [Setup Mode Screens, page 96](#).

Keys are used to input numerical data, enter setup screens, navigate within a screen, scroll through screens, and select setup values.

### NOTICE

To prevent damage to the softkey buttons, do not press the buttons with sharp objects such as pens, plastic cards, or fingernails.

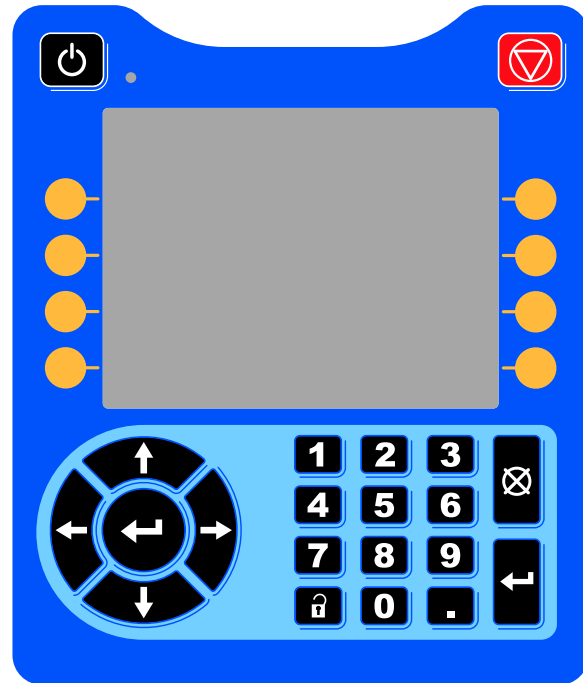

Figure 1 Advanced Display Module

## USB Upload Procedure

Use this procedure to install a system configuration file and/or a custom language file.

1. If necessary, follow the **USB Download Procedure**, to automatically generate the proper folder structure on the USB flash drive.
2. Insert the USB flash drive into the USB port of the computer.
3. The USB flash drive window automatically opens. If it does not, open the USB flash drive from within Windows Explorer.
4. Open the GRACO folder.
5. Open the system folder. If working with more than one system, there will be more than one folder within the Graco folder. Each folder is labeled with the corresponding serial number of the ADM. (The serial number is on the back of the module.)
6. If installing the system configuration settings file, place SETTINGS.TXT file into UPLOAD folder.

7. If installing the custom language file, place DISPTXT.TXT file into UPLOAD folder.
8. Remove the USB flash drive from the computer.
9. Install the USB flash drive into the USB port of the ProMix PD2K system USB port.
10. During the upload, USB BUSY displays on the screen.
11. Remove the USB flash drive from the USB port.

**NOTE:** If the custom language file was installed, users can now select the new language from the Language drop-down menu in the Advanced Setup Screen 1.







**NOTE:** If the system configuration settings file was installed, it is recommended to remove the file from the UPLOAD folder on the USB flash drive. This will prevent inadvertently overwriting any future setup changes.

## ADM Keys and Indicators

### NOTICE

To prevent damage to the softkey buttons, do not press the buttons with sharp objects such as pens, plastic cards, or fingernails.

Table 1 : ADM Keys and Indicators

Key	Function
 <p>Startup/Shutdown Key and Indicator</p>	<p>Press to startup or shutdown the pump/motor.</p> <ul style="list-style-type: none"> <li>• Solid green indicates that power is applied to the motor.</li> <li>• Solid yellow indicates that power to the motor is off.</li> <li>• Blinking green or yellow indicates that the system is in Setup mode.</li> </ul>
 <p>Stop</p>	<p>Press to immediately stop the system and remove motor power.</p>
 <p>Soft Keys</p>	<p>Press to select the specific screen or operation shown on the display directly next to each key. The top left soft key is the Edit key, which allows access to any settable fields on a screen.</p>
 <p>Navigation Keys</p>	<ul style="list-style-type: none"> <li>• <i>Left/Right Arrows:</i> Use to move from screen to screen.</li> <li>• <i>Up/Down Arrows:</i> Use to move among fields on a screen, items on a dropdown menu, or multiple screens within a function.</li> </ul>
<p>Numeric Keypad</p>	<p>Use to input values. See <a href="#">ADM Display, page 12</a>.</p>
 <p>Cancel</p>	<p>Use to cancel a data entry field.</p>
 <p>Setup</p>	<p>Press to enter or exit Setup mode.</p>
 <p>Enter</p>	<p>Press to choose a field to update, to make a selection, to save a selection or value, to enter a screen, or to acknowledge an event.</p>

## Soft Key Icons









The following icons appear in the ADM display, directly to the left or right of the soft key which activates that operation.

**NOTE:** Asterisks (\*) in the following tables indicate icons that appear only if manual override is enabled on [System Screen 5, page 102](#).

### NOTICE

To prevent damage to the softkey buttons, do not press the buttons with sharp objects such as pens, plastic cards, or fingernails.

**Table 2 : Soft Key Functions (Proportioner)**

Key	Function
* These icons appear only if manual override is enabled on <a href="#">System Screen 5, page 102</a>	
 Enter Screen	Press to enter screen for editing. Highlights editable data on a screen. Use Up/Down arrows to move between data fields on the screen.
 Exit Screen	Press to exit screen after editing.
 Accept	Press to accept calibration value.
 Cancel	Press to cancel or reject calibration value.
 Prime Pump*	Press to start a pump priming procedure.
 Line/Fill/Run*	Press to start a line fill procedure.
 Mix*	Press to start a spray procedure.
 Purge*	Press to start a purge procedure.
 Solvent Push*	Press to engage solvent push sequence (when applicable).

Key	Function
<b>* These icons appear only if manual override is enabled on <a href="#">System Screen 5, page 102</a></b>	
 Pre-Fill Pump*	Press to mark pump as filled. (Only for applicable pumps).























Key	Function
* These icons appear only if manual override is enabled on <a href="#">System Screen 5, page 102</a>	
 Standby*	Press to stop all pumps and put system in Standby.
 Stop*	
 Pressure Check	Press to start a pump pressure check.
 Volume Check	Press to start a pump volume check.
 Job Complete*	Press to log the material usage and increment the job number.
 Counter Reset	Press to reset the current usage counter.
 Move Cursor to Left	Appears on the User ID Keyboard screen. Use to move cursor to the left.
 Move Cursor to Right	Appears on the User ID Keyboard screen. Use to move cursor to the right.
 Erase All	Appears on the User ID Keyboard screen. Use to erase all characters.
 Backspace	Appears on the User ID Keyboard screen. Use to erase one character at a time.
 Upper Case/Lower Case	Appears on the User ID Keyboard screen. Use to change case (upper/lower).







Table 3 : Soft Key Functions (Applicator)

Key	Function
<b>* These icons appear only if manual override is enabled on <a href="#">System Screen 5, page 102</a></b>	
 Idle*	Press to put gun into Idle mode.
 Spray*	Press to put gun into Spray mode.
 Purge*	Press to put gun into Purge mode.
 Applicator Trigger*	Press to activate/deactivate gun trigger solenoid.
 Atomizing Air*	Press to activate/deactivate atomizing air solenoid when the applicator is in Idle, Spray, or Purge mode.
 Inner Shaping Air*	Press to activate/deactivate the inner shaping air solenoid when the applicator is in Idle or Spray mode.
 Fan Air*	Press to activate/deactivate fan air solenoid when the applicator is in Idle, Spray, or Purge mode.
 Outer Shaping Air*	Press to activate/deactivate the outer shaping air solenoid when the applicator is in Idle or Spray mode.
 Electrostatic Enable*	Press to activate/deactivate electrostatics when the applicator is in Spray mode and PD2K is in Mix mode.
 Calibrate Atomizing Air	Press to calibrate the atomizing air feedback voltage from the pressure transducer when the applicator is in Gun Off mode.

Advanced Display Module (ADM)

Key	Function
<b>* These icons appear only if manual override is enabled on <a href="#">System Screen 5, page 102</a></b>	
 Calibrate Inner Shaping Air	Press to calibrate the inner shaping air feedback voltage from the pressure transducer when the applicator is in Gun Off mode.

Key	Function
<p>* These icons appear only if manual override is enabled on <a href="#">System Screen 5, page 102</a></p>	
 Calibrate Fan Air	Press to calibrate the fan air feedback voltage from the pressure transducer when the applicator is in Gun Off mode.
 Calibrate Outer Shaping Air	Press to calibrate the outer shaping air feedback voltage from the pressure transducer when the applicator is in Gun Off mode.
 Calibrate Turbine Air	Press to calibrate the turbine air feedback voltage from the pressure transducer when the applicator is in Gun Off mode. This icon does not appear when the action is unavailable.
 Cup Wash*	Press to activate/deactivate the cup wash solenoid when the applicator is in Purge mode. This icon appears only if manual override is enabled. The icon does not appear when the action is unavailable.
 Dump Valve*	Press to activate/deactivate the dump valve solenoid when the applicator is in Purge or Idle mode. This icon appears only if manual override is enabled. The icon does not appear when the action is unavailable.

## Navigating the Screens

There are two sets of screens:

- The Run screens control mixing operations and display system status and data.
- The Setup screens control system parameters and advanced features.

Press  on any Run screen to enter the Setup screens. If the system has a password lock, the Password screen displays. If the system is not locked (password is set to 0000), System Screen 1 displays.

Press  on any Setup screen to return to the Home screen.





















Press the Enter soft key  to activate the editing function on any screen.

Press the Exit soft key  to exit any screen.

Use the other softkeys to select the function adjacent to them.

## Screen Icons

As you move through the screens, you will notice that icons are used frequently to simplify global communication. The following descriptions explain what each icon represents.

Screen Icons	
 User ID	 Job Number
 Potlife	1:1 Target Ratio
 Recipe Number	 Flow Rate
 Pressure	 Volume
 Material A	 Material B
 Material A+B	 Solvent
 Calendar	 Time
 Alarm/Advisory	 Deviation
 Atomizing Air	 Fan Air
 Shaping Air (Inner)	 Shaping Air (Outer)
 Preset	 Turbine Speed

## USB Download Procedure

Use the USB port on the ADM to download or upload data.

1. Enable USB downloads. See [Advanced Screen 3, page 133](#).
2. Remove the cover from the USB port on the bottom of the ADM. Insert the USB drive.
3. During the download, USB BUSY appears on the screen.
4. When the download is complete, USB IDLE appears on the screen. The USB drive may then be removed.

**NOTE:** If the download operation takes longer than 60 seconds, the message disappears. To determine if the USB is busy or idle, check the Error Status bar on the screen. If idle, remove the USB.

5. Insert the USB flash drive into the USB port of the computer.
6. The USB flash drive window automatically opens. If it does not, open the USB flash drive from within Windows® Explorer.

7. Open GRACO folder.
8. Open system folder. If downloading data from more than one system, there will be more than one folder. Each folder is labeled with the corresponding serial number of the ADM. (The serial number is on the back of the ADM.)
9. Open DOWNLOAD folder.
10. Open DATAXXX folder labeled with the highest number. The highest number indicates the most recent data download.
11. Open log file. Log files open in Microsoft® Excel® by default if the program is installed. They also can be opened in any text editor of Microsoft® Word.

**NOTE:** All USB logs are saved in Unicode (UTF-16) format. If opening the log file in Microsoft Word, select Unicode encoding.

12. Always reinstall the USB cover after removing the USB, to keep the drive free of dirt and dust.

# Pre-Operation Tasks

## Pre-operation Checklist

Go through the Pre-Operation Checklist daily, before each use.

### General Checklist

✓	Checklist
	<p><b>Operators are properly trained</b></p> <p>All operators are properly trained to safely operate all components of an integrated system as instructed in this manual.</p>
	<p><b>Pressure relief training</b></p> <p>All operators are trained in the <a href="#">Pressure Relief Procedure, page 25</a>.</p>
	<p><b>System grounded</b></p> <p>The system is thoroughly grounded and the operator and all persons entering the spray area are properly grounded. See <b>Grounding</b> in the Installation manual.</p>
	<p><b>Component condition</b></p> <p>All mechanical and electrical components are in good condition.</p>
	<p><b>Ventilation fans</b></p> <p>Ventilation fans are operating properly.</p>

✓	Checklist
	<p><b>Workpiece hangers</b></p> <p>Workpiece hangers are clean and grounded.</p>
	<p><b>Debris in spray area</b></p> <p>All debris is removed from the spray area, including flammable fluids and rags.</p>
	<p><b>Flammable fluids in spray booth</b></p> <p>All flammable fluids in the spray booth are in approved, grounded containers.</p>
	<p><b>All connections tight and correct</b></p> <p>Verify all electrical, fluid, air, and system connections are tight and installed according to the Installation manual, and show no signs of wear or leakage.</p>
	<p><b>Fluid supply containers filled</b></p> <p>Check component A and B and solvent supply containers.</p>

PD2K Checklist

✓	Checklist
	<p><b>Dose valves set</b></p> <p>Check that dose valves are set 1–1/4 turns open. Start with the settings recommended in <a href="#">Valve Settings, page 24</a>, then adjust as needed.</p>
	<p><b>Fluid supply valves open and pressure set</b></p> <p>The recommended component A and B fluid supply pressures are 1/2 to 2/3 of the target spray pressure.</p> <p><b>NOTE:</b> Low pressure systems may be set within a range of ± 100 psi (0.7 MPa, 7 bar); high pressure systems may be set within a range of ± 300 psi (2.1 MPa, 21 bar). If the inlet pressure is higher than the outlet pressure, ratio accuracy may be affected.</p>
	<p><b>Solenoid pressure set</b></p> <p>85-100 psi inlet air supply (0.6-0.7 MPa, 6-7 bar).</p>

Applicator Checklist

✓	Checklist
	<p><b>Warning Sign</b></p> <p>The warning sign provided with the applicator is mounted in the spray area where it can be easily seen and read by all operators.</p>
	<p><b>Conductive objects in spray area</b></p> <p>All conductive objects in the spray area are electrically grounded, and the floor of the spray area is electrically conductive and grounded.</p>
	<p><b>Electrostatics off and voltage discharged</b></p> <p>Electrostatics are off and voltage is discharged before entering the spray area for any cleaning or maintenance work.</p>

## Power On

1. Turn the AC Power Switch (P) ON (I = ON, 0 = OFF).
2. The Graco logo will display while the system initializes, followed by the Home screen.
3. Press the Start key . The system status will change from "System Off" to "Startup." Once the pumps are powered and are in the Home position, the system status will change from "Startup" to "Standby."

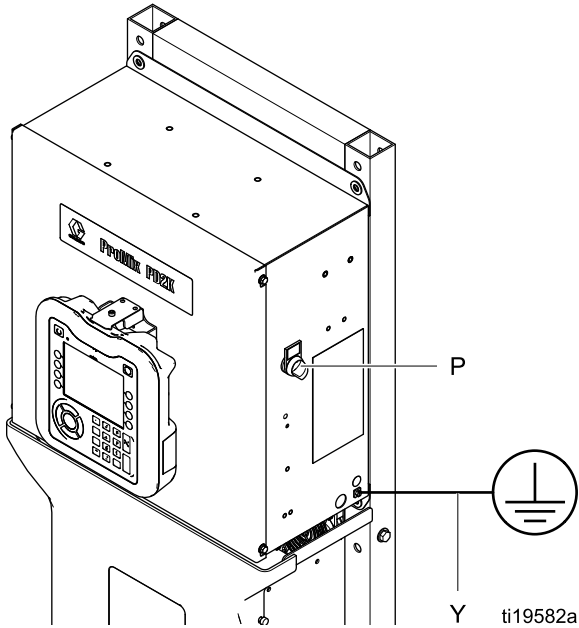

Figure 2 Power Switch

## Initial System Setup

1. Change optional setup selections to desired parameters, as described in [Setup Mode Screens, page 96](#).
2. Set recipe and flush information as described in [Recipe Screen, page 104](#) and [Flush Screen, page 106](#).

## Flush Before Using Equipment

The pump fluid section was tested with lightweight oil, which is left in the fluid passages to protect parts. To avoid contaminating your fluid with oil, flush the equipment with a compatible solvent before using the equipment.

## Valve Settings

Dose valves and purge valves are factory set with the hex nut (E) 1-1/4 turns out from fully closed.

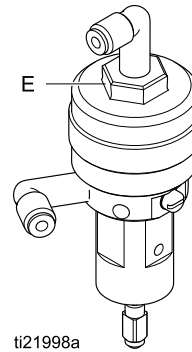

Figure 3 Valve Adjustment



# Pressure Relief Procedure



Follow the **Pressure Relief Procedure** whenever you see this symbol.

This equipment stays pressurized until pressure is manually relieved. To help prevent serious injury from pressurized fluid, such as skin injection, splashing fluid and moving parts, follow the **Pressure Relief Procedure** when you stop spraying and before cleaning, checking, or servicing the equipment.

## Without Color Change

**NOTE:** The following procedure relieves all fluid and air pressure in the system. Use your control interface to issue the necessary commands to your system.

1. Turn off the supply pumps. Open the drain valve on the supply line fluid filter to relieve pressure in the supply line.
2. Command the system to Standby. From Maintenance Screen 4 on the ADM, check the box in the field labeled Gun for the color or catalyst in the pump. Trigger the applicator to relieve pressure. Repeat for each pump in the system.
3. Flush the remote mix manifold and applicator. See [Flush Mixed Material, page 27](#).
4. Shut off the solvent supply pump. To relieve pressure, command the system to Purge and trigger the applicator. When the pressure is relieved, command the system to Standby to avoid getting a Purge Incomplete alarm.
5. If pressure remains in the solvent line between the solvent supply pump and the solvent valve:
  - VERY SLOWLY loosen a fitting to relieve pressure gradually.
  - Loosen the fitting completely.

## With Color Change

**NOTE:** The following procedure relieves all fluid and air pressure in the system.

1. Turn off the supply pumps. Open the drain valve on the supply line fluid filter to relieve pressure in the supply lines. Do this for each color.

--	--	--	--	--

If using an electrostatic gun, shut off the electrostatics before flushing the gun.

2. Trigger the gun to relieve pressure. From Maintenance Screen 4 on the ADM, check the box in the field labeled Gun for each color in the system, to manually open each color valve.
3. Set the system to Recipe 0 to flush the pumps and to purge to the applicator. Hold the gun trigger open after the solvent valve shuts off to relieve all pressure. When flushing is complete the system will go to Standby.
4. Shut off the solvent supply pump. Set the system to Recipe 0 to flush solvent from the pumps and to purge to the applicator. Command the system to Standby after just a couple of seconds, to avoid getting a Purge Incomplete alarm.
5. If pressure remains in the solvent line between the solvent supply pump and the solvent valve:
  - VERY SLOWLY loosen a fitting to relieve pressure gradually.
  - Loosen the fitting completely.
6. Verify on the ADM Home Screen that neither pump is showing any pressure.





# Operation Using Advanced Display Module (ADM)

## Prime and Fill the System

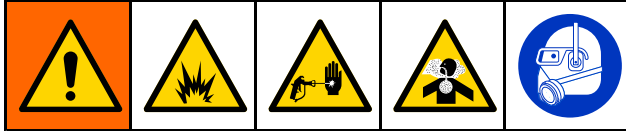
**NOTE:** See [Run Mode Screens, page 82](#), for further screen information, if needed.

**NOTE:** You must prime the input lines to the pumps or the inputs to the color change valves before priming the pump and filling the entire system.



1. If using an electrostatic gun, shut off the electrostatics before filling the lines.
2. Adjust the main air pressure. To ensure proper operation, set the main air pressure as close to 100 psi (0.7 MPa, 7.0 bar) as possible. Do not use less than 85 psi (0.6 MPa, 6.0 bar).
3. If this is the first time starting up the system, or if lines may contain air, purge as instructed under [Flush the System, page 27](#). The equipment was tested with lightweight oil, which should be flushed out to avoid contaminating your material.
4. **If the system is powered down**, press  on the ADM. Make sure that the system is in Standby mode and gun is in Idle mode.
5. Verify that the recipes and the flush sequences are programmed correctly by checking the [Recipe Screen, page 104](#) and the [Flush Screen, page 106](#).
6. Enable the Manual Override on [System Screen 5, page 102](#).
7. Enable Local paint trigger on [Gun Screen 1, page 118](#).
8. Go to the [Fill Screen, page 93](#).
9. Select the desired color to load. Press the Prime Pump key . The color will load the pump through the color stack and out the outlet stack dump valve.  
**NOTE:** In a single color system, step 8 can be skipped..
10. Press the Fill Line key  to run color out to the remote mix manifold. The pump will run until you press the Stop key  to stop the pump.
11. Press the Paint Trigger key on [Gun Screen, page 87](#).

12. Trigger the gun into a grounded reservoir or purge receptacle until the line is full, then press the Stop key .
13. Repeat for all material lines.

## Spraying

To spray in a multiple color system, also see [Multiple Color Systems, page 139](#).

**NOTE:** See [Run Mode Screens, page 82](#), for further screen information, if needed.

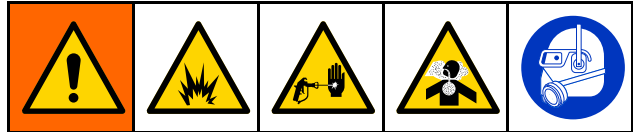

1. Command the system to Mix. The system will load the correct mixed material volume.  
**NOTE:** The system will automatically run a Mix Fill if the recipe is not currently loaded into the system. The Mix Fill volume calculation includes the remote mix manifold volume and the mixed material hose volume. The mixed material hose volume is determined by the gun hose length and diameter entered in [System Screen 4, page 102](#), and the remote-to-mix hose length and diameter also entered in [System Screen 4, page 102](#).
2. Adjust the flow rate by changing the target pressure (in Pressure Mode) or the target flow rate (in Flow Mode) on the Spray Screen or through the PLC. The fluid flow rate shown on the Spray screen is the combined total of component A and B out of the applicator.
3. Adjust the spray pattern as instructed in your applicator manual. See [Related Manuals, page 3](#).

### NOTICE

Do not allow a fluid supply tank to run empty. This can damage the pumps and lead to the proportioning of fluid and air that meets the ratio and tolerance settings of the equipment. This can further result in spraying uncatalyzed or poorly catalyzed material.

## Purging

To purge one color and fill with a new color, see [Color Change, page 139](#).

### Flush Mixed Material

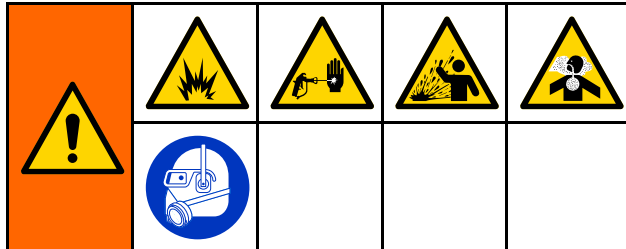

There are times when you only want to purge the remote mix manifold and the applicator, such as:

- end of potlife
  - breaks in spraying that exceed the potlife
  - overnight shutdown or end of shift
  - before servicing the remote mix manifold, hose or gun.
1. Command the system to Standby. (Puts applicator into Idle mode.)
  2. Turn off electrostatics and atomizing air. (Electrostatics and atomizing air will be disabled automatically.)

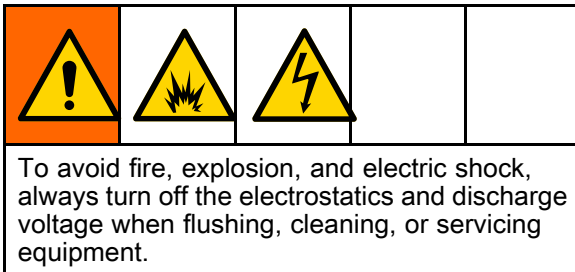

3. Command the system to Purge A or Purge B. (See [Purge Mode Sequence, page 54](#).) Trigger the applicator into a grounded metal pail until the purge sequence is complete. When done purging, the system automatically switches to Standby mode, signalling the applicator to Idle mode and to stop spraying.
4. If the system is not completely clean, repeat Step 5.

**NOTE:** For optimal efficiency, adjust purge sequence times so only one cycle is required.

**NOTE:** The remote mix manifold and applicator remain full of solvent after purging.

### Flush the System



Follow this procedure before:



- the first time material is loaded into the equipment
- servicing
- shutting down equipment for an extended period of time
- putting equipment into storage

### Single Color System

1. Relieve the pressure. See [Pressure Relief Procedure, page 25](#).
2. Disconnect the color and catalyst supply lines from the pump inlet manifolds, and connect regulated solvent supply lines.
3. Set the solvent supply pressure regulator at the lowest pressure possible. Generally a setting of 25–50 psi (0.18–0.35 MPa, 1.8–3.5 bar) is sufficient.
4. Enable Manual Override on [System Screen 5, page 102](#).
5. On the ADM, go to the Fill screen. Set the Material to Color (A). Press . The system will pump solvent through pump A all the way to the applicator.
6. Trigger the applicator until clean solvent dispenses.
7. On the ADM, go to the Fill screen. Set the Material to Catalyst (B). Press . The system will pump solvent through pump B all the way to the applicator.
8. Relieve the pressure. See [Pressure Relief Procedure, page 25](#)

## Color Change System

1. Relieve the pressure. See [Pressure Relief Procedure, page 25](#).
2. Attach regulated solvent supply lines as follows:
  - **Multiple color/single catalyst system:** On the color side, do not disconnect the color supply line from the inlet manifold of Pump A. Instead, connect a regulated solvent supply line to the designated solvent valve on the color valve manifold. On the catalyst side, disconnect the catalyst supply line from the inlet manifold of Pump B, and connect a regulated solvent supply line.
  - **Multiple color/multiple catalyst system:** Connect regulated solvent supply lines to the designated solvent valves on the color and catalyst valve manifolds. Do not connect solvent supply lines directly to the inlet manifolds of the pumps.
3. Set the solvent supply pressure regulator at the lowest pressure possible. Generally a setting of 25–50 psi (0.18–0.35 MPa, 1.8–3.5 bar) is sufficient.
4. On the ADM, go to the Fill screen. Select Color (A). Enter the color number in the box to the right.
5. Select the Flush Line box.
6. If the solvent is not already loaded, press the Prime softkey . The system will prime solvent into the selected pump and out the outlet dump valve.

7. Press the Fill softkey . The system will flush the selected Color (A) line with the solvent until the user presses Stop .
8. Trigger the applicator until clean solvent dispenses.
9. Repeat for each color line.
10. Relieve the pressure. See [Pressure Relief Procedure, page 25](#)

## Shutdown

1. Flush out the mixed material to avoid potlife errors and fluid setup in the lines. See [Purging, page 27](#).
2. Follow the [Pressure Relief Procedure, page 25](#).
3. Close the main air shutoff valve on the air supply line and on the control box.
4. Press  on the Display Module to turn off power to the pumps.
5. Shut off system power (0 position).

# Operation Using a Programmable Logic Controller (PLC)

## Network Communications and Discrete I/O

The ProMix PD2K Integrated system does not use a Booth Control module. Instead, it uses Network Communications and has optional Discrete I/O features to drive the system remotely.

Some automation control elements of the ProMix PD2K can be driven by a discrete input *or* network communications. These options need to be configured at the ADM (see [System Screen 5, page 102](#)). The following features can be set to 'Discrete' or 'Network':

- **Flow Control** – Means of adjusting the control set point (see **Flow Control Set Point** below).
- **Gun Trigger** – Means of signaling the ProMix PD2K when the applicator is triggered. The valve displayed is controlled by [Gun Screen 1, page 118](#).

**NOTE:** The Manual Override check box enables a user to operate the system before the automation (PLC) is available. Manual Override can be used to run all functions of the system if a proper applicator trigger signal is provided. It is not intended to be the main mode of control. Disable Manual Override during normal operation to avoid driving the system in a way that conflicts with the automation sequence.

## Discrete I/O

The ProMix PD2K does not supply power for Discrete I/O. A clear understanding of these inputs is necessary to properly integrate the ProMix PD2K with the PLC or networking device. Input and output connections are made at the Discrete I/O terminal strips on the Enhanced Fluid Control Module (EFCM) inside the control box.

Table 4 and Figure 5 show where discrete I/O connections are made on the ProMix PD2K.

**NOTE:** PD2K Discrete I/O are not isolated. Proper operation requires isolation from the PLC.

Table 4 PD2K Discrete I/O Connections

I/O Description	EFCM Connector	Pins	Type
Gun Trigger 1 Input	6	1,2	Normally Open Contact
Gun Trigger 2 Input	6	3,4	Normally Open Contact
Gun Trigger 3 Input	6	5,6	Normally Open Contact
Control Set Point	7	1,2	4-20 mA Input
Safety Interlock Input	7	11,12	Normally Open Contact

## Digital Inputs

- **Enhanced Fluid Control Module (EFCM)**

*Safety Interlock:* This normally open contact works like a soft emergency stop button. If the ProMix PD2K reads the input as CLOSED it interrupts system operation and removes power from the pumps regardless of the current operating mode. If the input is read as OPEN, the system operates normally. Do not toggle this input to put the system into Standby mode.

**NOTE:** This digital input is always enabled.

*Gun Trigger:* This normally open (maintained) contact provides a signal to the system to indicate whether or not an applicator is triggered. This input provides timing for alarm functions and also drives the flow control algorithm. If the input is OPEN the system operates as though the applicator is off. The input must be maintained CLOSED to signal that the applicator is triggered.

**NOTE:** The Gun Trigger discrete input must be enabled via Gun Setup Screen 1 on the ADM. If it is set to 'Local' or 'Network', the discrete input is ignored and the applicator trigger signal is handled via the network communications, or manually.

*If enabled, it is imperative that this signal be sent any time the applicator is triggered. Without the signal, the flow control features will not work.*

- **Speed Controller**

*Interlock Input:* This normally open contact turns the applicator off when activated. If the ProBell speed controller reads the input as CLOSED it interrupts system operation and puts the applicator into Gun Off mode. If the input is read as OPEN, the system operates normally. Install kit 24Z226 in the speed controller to use the Optional Interlock Input.

- **Electrostatic Controller**

*Electrostatic Enable:* Use to enable or disable electrostatics output.

- **0:** Disable electrostatics.
- **1:** Enable electrostatics. All other conditions for activating the electrostatics must be met.

*Safe Position Interlock:* The SAFE POSITION interlock and all other interlock inputs must be satisfied before electrostatics can be enabled. See the *ProBell Electrostatic Controller* and *Pro Xpc Auto Controller* manuals for details.

- **0:** Interlock not satisfied: If electrostatics are off, electrostatics disabled. If electrostatics are on, no change to electrostatics.
- **1:** Interlock satisfied; electrostatics activation is not locked by this input.

**NOTE:** Switching from 1 to 0 does not deactivate the electrostatics. Symbol A10 on the display screen shows that this signal is satisfied. See *Screen Areas* in the *ProBell Electrostatic Controller* manual 3A3657 for more information.

*24 VDC Interlock:* The 24 VDC Interlock and all other interlock inputs must be satisfied before electrostatics can be enabled. See the *ProBell Electrostatic Controller* manual 3A3657 for details.

- **0:** Interlock not satisfied; electrostatics disabled.
- **1:** Interlock satisfied; electrostatics activation is not locked by this input. Symbol A9 on the display screen shows that this signal is satisfied. See *Screen Areas* in the *ProBell Electrostatic Controller* manual 3A3657 for more information.

## Digital Outputs

- **Speed Controller**

*System Status Output:* Used to indicate that the turbine is active and currently spinning.

- **0:** Turbine is disabled and not active.
- **1:** Turbine is active and currently spinning.

- **Electrostatic Controller**

**NOTE:** The voltage level for a digital output depends on the type of output selected on *Setup Screen 5 (Digital Output Type Select)* in the *ProBell Electrostatic Controller* manual 3A3657 for more information.

*Safe-to-Move Output:* Indicates whether the applicator can be moved out of SAFE POSITION to begin paint application. This output is tied to the arc detection blanking time setting on Setup screen 9 of the electrostatic controller. The blanking timer begins counting down when high voltage is enabled. When the timer has reached zero, the Safe-to-Move Output is switched from 0 to 1.

- **0:** Applicator must not be moved out of SAFE POSITION because arc detection is blanked and electrostatics are activated.
- **1:** Applicator allowed to be moved out of SAFE POSITION because arc detection is effective or electrostatics are deactivated. See *Safe Position Mode* in the *ProBell Electrostatic Controller* manual 3A3657 for more information.

**NOTE:** The voltage level for a digital output depends on the type of output selected on *Setup Screen 5 (Digital Output Type Select)* in the *ProBell Electrostatic Controller* manual 3A3657 for more information.

*Error Output:* Used to signal detection of an electrostatic error condition.

- **0:** No electrostatic error condition detected.
- **1:** An electrostatic error condition has been detected and reported.

**NOTE:** Reset by Error Reset Input or by local confirmation.

**Electrostatic Discharge Output:** Use to indicate when electrostatics have been fully discharged. Set the electrostatic discharge time setting on *Setup screen 10 (Configuration C2)*. The discharge timer begins counting down when electrostatics have been disabled. When the timer reaches zero, the Electrostatic Discharge Output is switched from low (0) to high (1).

- **0:** Electrostatic voltage not discharged.
- **1:** Electrostatic voltage discharge time has elapsed.

## Analog Inputs

### Enhanced Fluid Control Module (EFCM)

**Flow Control Set Point:** When enabled, this 4-20mA signal input is used to set and adjust the operating flow control set point. The ProMix PD2K scales the set point linearly from 0 to the Max Set Point setting.  
*Examples,*

- **In Flow Control Mode:** If the Max Set Point is 500 cc/min, a 4mA signal is 0 cc/min and a 20mA signal is 500 cc/min.
- **In Pressure Control Mode:** If the Max Set Point is 500 psi, a 4mA signal is 0 psi and a 20mA signal is 500 psi.

**NOTE:** The Flow Control discrete input must be enabled via Configure Screen 5 on the ADM. If set to 'Network' the discrete input is ignored and set point adjustment is handled via the network communications.

### 4–20 mA Flow Control Set Point Input

Figure 4

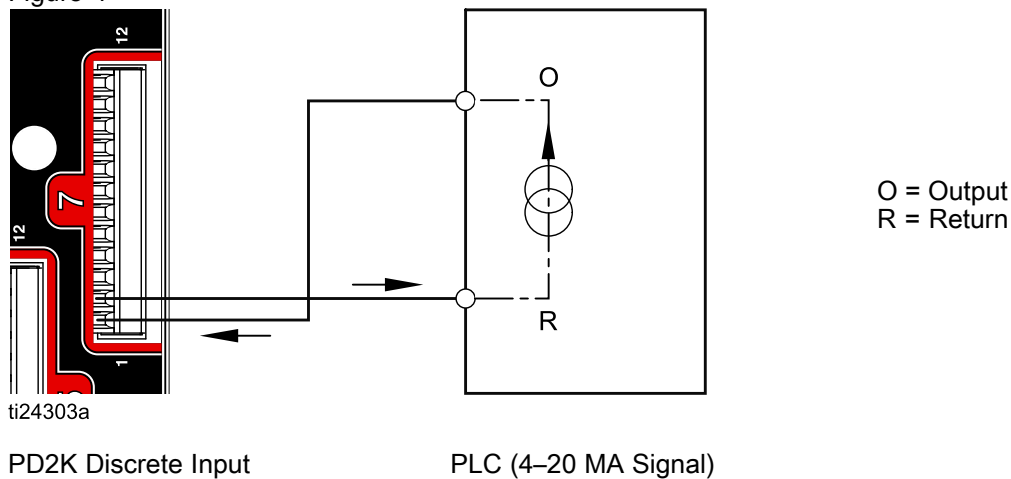

Discrete I/O Connections on EFCM

Figure 5

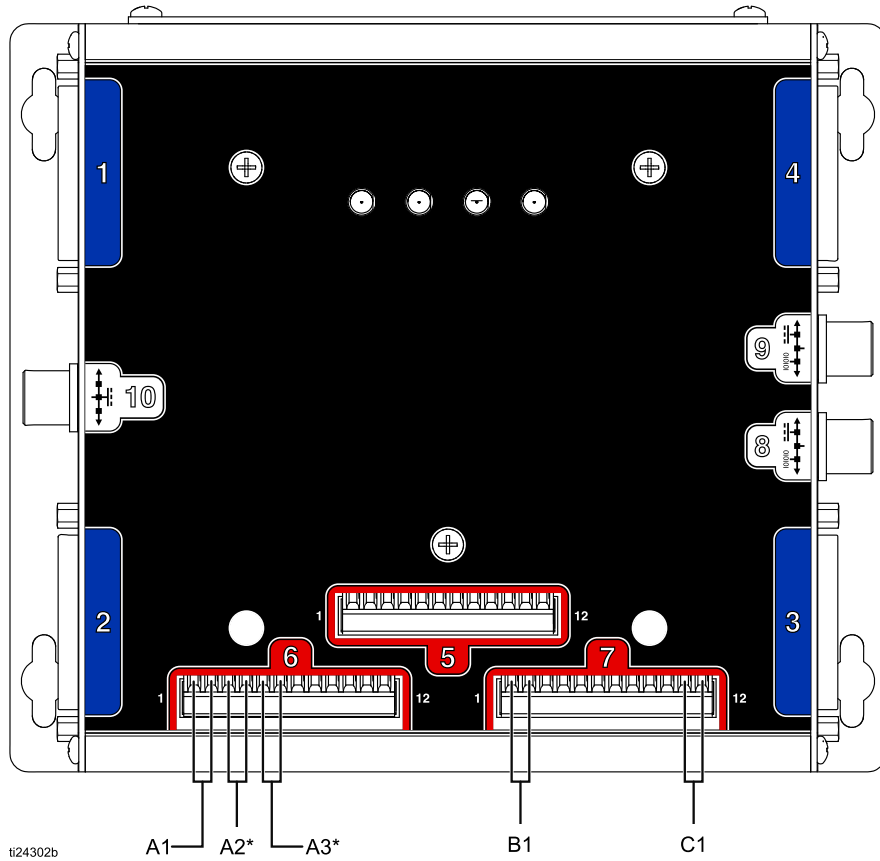

**KEY**

A1 Gun Trigger 1 Input

A2\* Gun Trigger 2 Input

A3\* Gun Trigger 3 Input

B1 Analog Set Point Input

C1 Safety Interlock Input

\* Multiple applicator trigger inputs are only supported with Gun Type: AirPro Auto, G40 Auto, and AirPro EFX.



## Communication Gateway Module (CGM) Details

### CGM Overview

The CGM provides a control link between the PD2K system and a selected fieldbus. This linkage provides the means for remote monitoring and control by external automation systems.

### CGM Kits

The PD2K system comes with a Modbus TCP CGM. Other communication protocols are available, but require both the CGM installation kit and the appropriate CGM and the CGM. See the tables below.

CGM Installation Kit Part No.	Field Bus	Manual
17L710	All	334494

CGM Part No.	Fieldbus	Manual
CGMDN0	DeviceNet	312864
CGMEP0	EtherNet/IP	312864
CGMPN0	PROFINET	312864
24W462	Modbus TCP	334183

## Network Communication I/O Data Map

The PD2K has PLC Diagnostic Screens built into the software that assist in the system integration process. See [Setup Mode Screens, page 96](#).

### ProMix PD2K Network Outputs

The ProMix PD2K Network Outputs are Read-Only and should be treated as inputs to a PLC or other networking device. These registers

provide various system and component status, measurement, and set point values. See [Network Output Data Map \(Read Only\), page 42](#).

#### OUTPUT REGISTER 00: Current System Mode

The Current System Mode register contains a number that indicates the current operation mode of the PD2K system.

Number	Operation Mode	Description
1	Pump Off	The pumps are currently powered down and the system is not in operation.
2	Recipe Change	The system is in the process of a color change sequence.
3	Recipe Change: Purge A	The system is purging material A as part of a recipe change.
4	Recipe Change: Purge B	The system is purging material B as part of a recipe change.
5	Recipe Change: Fill	The system is filling the hose from the remote valves to the mix manifold with material as part of a recipe change.
6	Mix Fill	The system is mixing material at ratio through the mix manifold and out the applicator.
7	Mix	The system is currently mixing/spraying material.
8	Mix Idle	The system has paused mix operation due to the absence of an applicator trigger signal.
9	Purge A	The system is purging material A while in Standby.
10	Purge B	The system is purging material B while in Standby.
11	Standby: Mix Ready	The system has a valid recipe loaded out to the applicator.
12	Standby: Fill Ready	The system has a valid recipe loaded in the pumps, but not in the applicator.
13	Standby: Mix Not Ready	The system requires that a recipe change operation be completed.
14	Standby: Alarm	The system has an active alarm.
15	Line Filling/Flushing	The system is currently filling/flushing line.
16	Pump Prime/Flush	The system is priming/flushing a pump.
17	Maintenance/Calibration	The system is currently performing a calibration or maintenance procedure.
18	Mix: Solvent Push	The system is currently mixing/spraying with solvent push engaged.

**OUTPUT REGISTERS 01, 02, 03, and 04: Pump Status**

The Pump Status registers contain a number that indicates the state of Pumps 1 — 4. This status can be used for general monitoring of the pump state, or as an indicator for driving independent pump operations. See [INPUT REGISTER 02: Flush/Prime Pump Command](#), page 46.

**Table 5 Pump States for Output Registers 01–04**

No.	Pump State	Description
0	Off	The pump is powered down or not enabled.
1	Standby	The pump is powered but not currently active.
2	Busy	The pump is currently in a recipe change or mixing operation.
3	Flushing	The pump is currently flushing with solvent
4	Priming	The pump is currently priming with material.

**OUTPUT REGISTER 05: Actual Mix Flow/Pressure**

The Actual Mix Flow register reports back the instantaneous mixing flow rate in cc/min or pressure in psi. Flow or Pressure is determined by Fluid Control settings.

**NOTE:** This register is valid only during a mix operation.

**OUTPUT REGISTER 06: Actual Mix Ratio**

The Actual Mix Ratio register contains the instantaneous calculated mix ratio.

- The value reported is the ratio antecedent multiplied by 100. The ratio consequent is always 1.

*Example:* Value = 250 >> A mix ratio of 2.5:1 (Material A to Material B)

- If the current recipe ratio is 0:1 (1K recipe) this value will be 0.

**NOTE:** This register is valid only during a mix operation.

**OUTPUT REGISTER 07: Actual Mix Potlife Remaining**

The Actual Potlife Remaining register contains the current amount of time remaining in the active recipe's potlife in seconds.

**NOTE:** If potlife is disabled for the active recipe or at initial startup this value will be 0xFFFFFFFF.

**OUTPUT REGISTER 08: Active Recipe Number**

The Active Recipe Number register contains the number of the active recipe (1 – 60).

- This value is 0 if the system was flushed.
- This value is 61 if the system does not know the current loaded recipe, if the recipe is invalid, or at initial startup.

**OUTPUT REGISTER 09: Active Recipe Material A**

The Active Recipe Material A register contains the number of the Color (1 – 30) that is associated with the current recipe.

- This value is 0 if the system was flushed.
- This value is 61 if the current recipe is invalid or at initial startup.

**OUTPUT REGISTER 10: Active Recipe Material B**

The Active Recipe Material B data register contains the number of the Catalyst (31 – 34) that is associated with the current recipe.

- This value is 0 if the system was flushed.
- This value is 61 if the current recipe is invalid or at initial startup.

- This value is 0 if the current recipe ratio is 0:1 (1K recipe).

**OUTPUT REGISTER 11: Active Recipe Material A Flush Sequence**

The Active Recipe Material A Flush Sequence register contains the number of the Flush Sequence (1 – 5) that is associated with the Color pump of the current recipe.

If the current recipe is invalid this value reflects the Flush Sequence associated with Material A pump of recipe 0.

**OUTPUT REGISTER 12: Active Recipe Material B Flush Sequence**

The Active Recipe Material B Flush Sequence register contains the number of the Flush Sequence (1 – 5) that is associated with the Catalyst pump of the current recipe.

- If the current recipe is invalid this value reflects the Flush Sequence associated with Material B pump of recipe 0.
- This value is 0 if the current recipe ratio is 0:1 (1K recipe).

**OUTPUT REGISTER 13: Active Recipe Ratio Set Point**

The Active Recipe Ratio Set Point data register contains the ratio set point associated with the current recipe.

- The value reported is the ratio antecedent multiplied by 100. The ratio consequent is always 1.

*Example:* Value = 250 >> A mix ratio of 2.5:1 (Material A to Material B)

- This value is 0 if the current recipe ratio is 0:1 (1K recipe).

**OUTPUT REGISTER 14: Active Recipe Potlife Timeout Set Point**

The Active Recipe Potlife Timeout Set Point register contains the set point for the potlife time associated with the current recipe in minutes.

- This value is 0 if the potlife time is disabled for the current recipe.

**OUTPUT REGISTER 15: Safety Interlock Input Status**

The Safety Interlock Input Status register contains the status of the Safety Interlock Discrete Input of the EFCM and three electrostatic interlocks.

- The value will be 0 if the inputs are satisfied.
- The value will be 1 if the input are not satisfied.

*See Safety Interlock in [Digital Inputs](#), page 29.*

**OUTPUT REGISTER 16: Current Gun Mode**

The Current Gun Mode register contains a number that indicates the current operation mode of the applicator.

Number	Operation Mode	Description
1	Gun Off	Applicator is currently powered down and the applicator is not in operation. All solenoids are disabled.
2	Gun Off Alarm	Applicator has an active alarm.
3	Startup	Applicator is turning on.
4	Idle	Applicator is in idle mode — Turns off all solenoids and electrostatics upon mode entry. <ul style="list-style-type: none"> <li>• Gun Trigger can be enabled/disabled</li> <li>• Atomizing Air / Inner Air can be enabled/disabled</li> <li>• Fan Air / Outer Air can be enabled/disabled</li> <li>• Dump valve can be enabled/disabled (ProBell only)</li> <li>• Auxiliary solenoids can be enabled/disabled</li> <li>• Electrostatics are disabled</li> </ul>
5	Spray	Applicator is in spray mode — Atomizing and Fan Air are automatically enabled. <ul style="list-style-type: none"> <li>• Gun Trigger can be enabled/disabled</li> <li>• Atomizing Air / Inner Air can be enabled/disabled</li> <li>• Fan Air / Outer Air can be enabled/disabled</li> <li>• Auxiliary solenoids can be enabled/disabled</li> <li>• Electrostatics can be enabled/disabled</li> </ul>
6	Purge	Applicator is in purge mode — Turns off all solenoids and electrostatics upon mode entry. <ul style="list-style-type: none"> <li>• Gun Trigger can be enabled/disabled</li> <li>• Atomizing Air can be enabled/disabled</li> <li>• Fan Air can be enabled/disabled</li> <li>• Dump valve can be enabled/disabled (ProBell only)</li> <li>• Cup Wash valve can be enabled/disabled (ProBell only)</li> <li>• Auxiliary solenoids can be enabled/disabled</li> <li>• Electrostatics are disabled</li> </ul>

**OUTPUT REGISTER 17: Active Preset Number**

The Active Preset register contains the status of applicator’s current preset. Preset is associated with the following parameters:

- Flow/Pressure
- Atomizing Air / Inner Air
- Fan Air / Outer Air
- Speed
- Voltage
- Current

**OUTPUT REGISTER 18: Air Control Solenoid Status**

The Air Control Solenoid Status register contains the status of the air control solenoids.

- The value will be 0 if the solenoid is off.
- The value will be 1 if the solenoid is on.

Bit	Name
0	Atomizing Air / Inner Air
1	Fan Air / Outer Air
2	Paint Trigger 1
3	Auxiliary 1 / Paint Trigger 2* / Dump**
4	Auxiliary 2 / Paint Trigger 3* / Cup Wash**
5	Auxiliary 3

\* Multiple applicator triggers are only supported with Gun Type: AirPro Auto, G40 Auto, and AirPro EFX..

\*\* When Gun Type is equal to ProBell, Dump valve is mapped to bit 3 and Cup Wash valve is mapped to bit 4.

**OUTPUT REGISTER 19: Target Shaping Air 1**

The Target Shaping Air 1 register contains the current applicator shaping air 1 set point. The target is adjusted by the offset value when offsets are enabled. This register represents the inner air for a rotary atomizer or atomizing air for conventional and electrostatic applicators. Value ranges from 7 – 99 PSI.

**OUTPUT REGISTER 20: Target Shaping Air 2**

The Target Shaping Air 2 register contains the current applicator shaping air 2 set point. The target is adjusted by the offset value when offsets are enabled. This register represents the inner air for a rotary atomizer or atomizing air for conventional and electrostatic applicators. Value ranges from 7 – 99 PSI.

**OUTPUT REGISTER 21: Target Turbine Speed**

The Target Turbine Speed register contains the current applicator speed set point. The target is adjusted by the offset value when offsets are enabled. This register is only used for rotary atomizer applications. Value ranges from 10 – 60 kRPM.

**OUTPUT REGISTER 22: Target Voltage**

The Target Voltage register contains the current set point for electrostatic voltage. The target is adjusted by the offset value when offsets are available. This register is only used for rotary atomizer and electrostatic applicators. Value ranges from 0, 10 – 100 kV.

**OUTPUT REGISTER 23: Actual Shaping Air 1**

The Actual Shaping Air 1 register contains the actual shaping air 1 in PSI at the outlet of the air controller V2P. This register represents the inner air for a rotary atomizer or atomizing air for conventional and electrostatic applicators. Value ranges from 0 - 99 PSI.

**OUTPUT REGISTER 24: Actual Shaping Air 2**

The Actual Shaping Air 2 register contains the actual shaping air 2 in PSI at the outlet of the air controller V2P. This register represents the inner air for a rotary atomizer or atomizing air for conventional and electrostatic applicators. Value ranges from 0 - 99 PSI.

**OUTPUT REGISTER 25: Actual Speed**

The Actual Speed register contains the actual turbine speed in 1000 revolutions per minute (kRPM). This register is only used for rotary atomizer applicators. Value ranges from 0 – 60 kRPM.

**OUTPUT REGISTER 26: Actual Voltage**

The Actual Voltage register contains the actual electrostatic voltage in kilovolts (kV). This register

is only used for rotary atomizer and electrostatic applicators. Value ranges from 0 - 100 kV.

**OUTPUT REGISTER 27: Actual Current**

The Actual Current register contains the actual electrostatic current in microamps (µA). This register is only used for rotary atomizer and electrostatic applicators. Value ranges from 0 - 150 µA.

**OUTPUT REGISTER 28: Trigger Status**

The Gun Trigger Status register contains the status of the Gun Trigger solenoid.

- The value is 0 if the input is OPEN (applicator not triggered).
- The value is 1 if the input is CLOSED (applicator triggered).

This data register is valid only for systems configured to use the discrete input for the Gun Trigger. See [Gun Trigger Signal, page 103](#).

Bit	Name
0	Gun 1
1	Gun 2*
2	Gun 3*

\* Multiple applicator triggers are only supported with Gun Type: AirPro Auto, G40 Auto, and AirPro EFX.



**OUTPUT REGISTER 29: Electrostatic Trigger Status**

The Electrostatic Trigger Status register contains the status of the electrostatic enable.

- The value is 0 if the input is OPEN (electrostatics off).
- The value is 1 if the input is CLOSED (electrostatics on).

**OUTPUT REGISTERS 30 – 38: DCS Command Structure**

See [Dynamic Command Description, page 63](#).

**Network Output Data Map (Read Only)**

Network Output ID	Modbus Register	Parameter Name	Data Type	Units	Range
00	40100	Current System Mode	uint32	NONE	1 = Pump Off 2 = Color Change 3 = Color Change: Purge A 4 = Color Change: Purge B 5 = Recipe Change: Fill 6 = Mix Fill 7 = Mix 8 = Mix Idle 9 = Purge A 10 = Purge B 11 = Standby: Mix Ready 12 = Standby: Fill Ready 13 = Standby: Mix Not Ready 14 = Standby: Alarm 15 = Line Filling/Flushing 16 = Pump Prime/Flush 17 = Maintenance/Calibration 18 = Mix: Solvent Push
01	40102	Pump 1 Status	uint32	NONE	0 = Off 1 = Standby 2 = Busy 3 = Flushing 4 = Priming
02	40104	Pump 2 Status	uint32	NONE	0 = Off 1 = Standby 2 = Busy 3 = Flushing 4 = Priming

Operation Using a Programmable Logic Controller (PLC)

Network Output ID	Modbus Register	Parameter Name	Data Type	Units	Range
03	40106	Pump 3 Status	uint32	NONE	0 = Off 1 = Standby 2 = Busy 3 = Flushing 4 = Priming
04	40108	Pump 4 Status	uint32	NONE	0 = Off 1 = Standby 2 = Busy 3 = Flushing 4 = Priming
05	40110	Actual Mix Flow/Pressure	uint32	cc/min or PSI	1 - 1600
06	40112	Actual Mix Ratio	uint32	NONE	0 - 5000 Ex: 100 → ratio of 1.00:1
07	40114	Actual Mix Potlife Remaining	uint32	min	0 - 999
08	40116	Active Recipe Number	uint32	NONE	0 - 61
09	40118	Active Recipe Material A	uint32	NONE	1 - 30, 61
10	40120	Active Recipe Material B	uint32	NONE	31 - 34, 61
11	40122	Active Recipe Material A Flush Sequence	uint32	NONE	1 - 5
12	40124	Active Recipe Material B Flush Sequence	uint32	NONE	1 - 5
13	40126	Active Recipe Ratio Set Point	uint32	NONE	0 - 5000 Ex: 100 → ratio of 1.00:1
14	40128	Active Recipe Potlife Time Set Point	uint32	min	0 - 999
15	40130	Safety Interlock Input Status	uint32	NONE	0 = Open 1 = Closed

Operation Using a Programmable Logic Controller (PLC)

Network Output ID	Modbus Register	Parameter Name	Data Type	Units	Range
16	40132	Current Gun Mode	uint32	NONE	1 = Gun Off 2 = Gun Off Alarm 3 = Startup 4 = Idle 5 = Spray 6 = Purge
17	40134	Gun Active Preset Number	uint32	NONE	0, 1 - 98
18	40136	Gun Air Control Solenoids Status	uint32	NONE	bit 0 = Atomizing Air / Inner Air bit 1 = Fan Air / Outer Air bit 2 = Paint Trigger 1 bit 3 = Auxiliary 1 / Paint Trigger 2* / Dump bit 4 = Auxiliary 2 / Paint Trigger 3* / Cup Wash bit 5 = Auxiliary 3 * = Multiple applicator triggers are only supported with Gun Type: AirPro Auto, G40 Auto, and AirPro EFX.
19	40138	Target Shaping Air 1	uint32	PSI	7 - 99
20	40140	Target Shaping Air 2	uint32	PSI	7 - 99
21	40142	Target Speed	uint32	kRPM	10 - 60
22	40144	Target Voltage	uint32	kV	0 - 100
23	40146	Actual Shaping Air 1	uint32	PSI	0 - 99
24	40148	Actual Shaping Air 2	uint32	PSI	0 - 99
25	40150	Actual Speed	uint32	kRPM	0 - 60
26	40152	Actual Voltage	uint32	kV	0 - 100
27	40154	Actual Current	uint32	uA	0 - 150
28	40156	Gun Trigger Status	uint32	NONE	bit 0 = Gun 1 bit 1 = Gun 2* bit 2 = Gun 3* * = Multiple applicator triggers are only supported with Gun Type: AirPro Auto, G40 Auto, and AirPro EFX.

Network Output ID	Modbus Register	Parameter Name	Data Type	Units	Range
29	40158	Electrostatic Trigger Status	uint32	NONE	0 = Gun not triggered 1 = Gun triggered
30	40800	Command Acknowledge	uint32	NONE	0 = NOP 1 = BUSY 2 = ACK 3 = NAK 4 = ERR
31	40802	Command Return 0	uint32	N/A	N/A
32	40804	Command Return 1	uint32	N/A	N/A
33	40806	Command Return 2	uint32	N/A	N/A
34	40808	Command Return 3	uint32	N/A	N/A
35	40810	Command Return 4	uint32	N/A	N/A
36	40812	Command Return 5	uint32	N/A	N/A
37	40814	Command Return 6	uint32	N/A	N/A
38	40816	Command Return 7	uint32	N/A	N/A

\* Only used when Multiple Guns is enabled.



DCS Register

## ProMix PD2K Network Inputs

The ProMix PD2K Network Inputs are Write-Read capable, but should be treated as outputs from a PLC or other networking device. These registers allow the user to control system operation and configure system settings remotely. Invalid values (i.e. out of bounds or not consistent with system configuration) will be ignored by the ProMix PD2K. All values must be written as integers. Floating point numbers are not supported.

Do not rely on these registers for Read status, other than to confirm data that has been written and accepted.

**NOTE:** The PD2K system does not refresh the values for these registers. At power up all input registers initialize to invalid values.

### INPUT REGISTER 00: System Mode Command

The System Mode Command register accepts a number that represents a command to the PD2K system to initiate a particular operation. Some operation modes may be initiated only under certain conditions (see Figures 5 – 9 for details).

Input Value	Operation Mode	Description
0	No OP	The system takes no action.
1	Power Pumps	The system powers on or powers off the pumps.
2	Remote Stop	The system stops all current operations and turns off power to the pumps.
3	Color Change	The system initiates a recipe change.
4	Mix Fill	The system fills the mix manifold and applicator with material at ratio for a valid recipe.
5	Mix	The system initiates a mix/spray cycle.
6	Purge A	The system purges only Material A out through the applicator.
7	Purge B	The system purges only Material B out through the applicator.
8	Standby	The system puts all active pumps into Standby mode.
9	Purge Standard	The system will determine purge sequence. The user does not have to perform a purge B and purge A separately.
10	Purge (Inactive)	This command is only valid if Multiple Guns is enabled. The system will purge an inactive applicator. (See also Register 7.)
11	Solvent Push	The system initiates the solvent push sequence while mixing or spraying.

### INPUT REGISTER 01: Pump Flush Sequence Number / Prime Material Number

The Pump Flush Sequence/Prime Material Selection register is used in conjunction with the Flush/Prime Pump Command register (see INPUT REGISTER 02 below) to independently prime or flush an inactive pump.

- Write a value between 1 and 5 if flushing a pump.
- Write a value between 1 and 30 if priming a Color pump.
- Write a value between 31 and 34 if priming a Catalyst pump.
- Write a value of 41–43 (instead of 31) if your system has multiple applicators and Catalyst 1 is common to more than one applicator. See [Appendix B: Multiple Guns, page 171](#).
- Write a value of 51–53 (instead of 33) if your system has multiple applicators and Catalyst 3 is common to more than one applicator. See [Appendix B: Multiple Guns, page 171](#).

**NOTE:** It is important that the user know which material is assigned to each pump. An invalid selection will be ignored by the ProMix PD2K.

### INPUT REGISTER 02: Flush / Prime Pump Command

The Flush/Prime Pump Command register is used in conjunction with the Pump Flush Sequence/Prime Material Selection register (see INPUT REGISTER 01) to independently prime or flush an inactive pump. The desired pump **MUST** be in Standby mode. Confirm by reading the corresponding Pump Status output register (see OUTPUT REGISTERS 01 – 04).

If an invalid Flush Sequence or invalid material number is written to the Pump Flush Sequence/Prime Material Selection register then the Flush/Prime command will be ignored. The user must know what material is assigned to each pump. (See Color Change Kits Instruction Manual 332455 for color/catalyst pump mapping.)

**NOTE:** If two pumps are currently mixing and an inactive pump is commanded to flush or prime it will continue its operation to completion without affecting the system mode status. When the mixing operation is complete, the system status will reflect Standby mode while the flushing/priming pump completes its operation.

### INPUT REGISTER 03: Mix Control Set Point

The Mix Control Set Point register is used to set and adjust the mixing fluid control set point. It also is used as the fluid control set point for pump 1 when running a 1K recipe. It can be changed at any time, and the system will immediately adjust to the new set point.

- If the system is configured for Flow Control this value can be set between 5 and 1600 cc/min for a 2K recipe, and between 5 and 800 for a 1K recipe.
- If the system is configured for Pressure Control this value can be set between 0 and the maximum pump pressure in PSI.

**NOTE:** The Flow Control must be configured to 'Network' via [System Screen 5, page 102](#). If set to 'Discrete' this register is ignored and set point adjustment is handled via the discrete input. See [Analog Inputs, page 31](#).

### INPUT REGISTER 04: Go To Recipe Number

The Go To Recipe Number register is used as a queue for the next recipe to be loaded when a recipe change is initiated. A number between 0 and 60 can be written to this register. However, a recipe must be enabled via the ADM before it can be loaded. See [Recipe Screen, page 104](#).

**NOTE:** Writing to this register does not trigger a recipe change. See [Color Change Sequence, page 59](#).

### INPUT REGISTER 05: Clear Active Alarm

The Clear Active Alarm register is used to acknowledge an alarm remotely so that the system may resume operation. Be sure that the alarm condition has been alleviated. Write a 1 to this register to acknowledge the latest active alarm. If more than one alarm is currently active only the most recent alarm will be acknowledged. A repeated write should be performed to clear any remaining active alarms.

(See [System Errors, page 140](#) for more information on clearing alarms.)

**NOTE:** This register is not polled by the ProMix PD2K. An alarm is cleared only when a value of '1' is written to this register. It is recommended that the automation reset this register by writing a 0 to it at all other times to avoid inadvertently clearing an alarm.\*

**INPUT REGISTER 06: Job Complete**

The Job Complete register is used to log the current job remotely. Write a '1' to the register to command the ProMix PD2K to flag a job complete.

*(See Usage Screen, page 94 for more information on Job Logs and Job Complete.)*

**NOTE:** This register is not polled by the ProMix PD2K. A job is logged only when a value of '1' is written to this register. It is recommended the automation reset this register by writing a 0 to it at all other times to avoid inadvertently logging a job.\*

\* It is recommended to wait at least 500 msec for the PD2K to process before resetting to '0'.

**INPUT REGISTER 07: Gun Mode Command**

The Gun Mode Command register accepts a number that represents a command to the applicator to initiate a particular operation. Some operation modes may be initiated only under certain conditions.

No.	Operation Mode	Description
0	No Op	The system takes no action.
1	Power	The applicator powers up.

No.	Operation Mode	Description
2	Remote Stop	The applicator stops all current operations and turns off the applicator.
3	Idle	The applicator transitions into idle mode (see <a href="#">Idle Mode, page 87</a> ).
4	Spray	The applicator transitions into spray mode (see <a href="#">Spray Mode, page 88</a> ).
5	Purge	The applicator transitions into purge mode (see <a href="#">Purge Mode, page 90</a> ).

**INPUT REGISTER 08: Gun Goto Preset Number**

The Goto Preset Number register is used to change the spray parameters. A number between 0 and 98 can be written to this register. Preset values contain set points for inner/atomizing air, outer/fan air, turbine speed, electrostatic voltage, and electrostatic current. These values update automatically based on the preset value received. If the dynamic preset value of '0' is received, the system maintains the current spray parameters and the set points can then be changed independently. (Reference Input Registers 10–14.)



**INPUT REGISTER 09: Gun Air Control Solenoids**

The Air Control Solenoids register is used to enable/disable the air control solenoids. These air control solenoid bits use binary format to control the register.

- Write a value of '1' to turn the solenoid on.
- Write a value of '0' to turn the solenoid off.

Bit	Name
0	Atomizing Air / Inner Air
1	Fan Air / Outer Air
2	Paint Trigger 1
3	Auxiliary 1 / Paint Trigger 2* / Dump**
4	Auxiliary 2 / Paint Trigger 3* / Cup Wash**
5	Auxiliary 3

\* Multiple applicator triggers are only supported with Gun Type: AirPro Auto, G40 Auto, and AirPro EFX..

\*\* When Gun Type is equal to ProBell, Dump valve is mapped to bit 3 and Cup Wash valve is mapped to bit 4.

- Atomizing Air / Inner Air (Shaping Air 1) — Turns on/off the shaping air 1. For a rotary atomizer, this is for the inner shaping air. For conventional and electrostatic applicators, this is for atomizing air.
- Fan Air / Outer Air (Shaping Air 2) — Turns on/off the shaping air 2. For a rotary atomizer, this is for the outer shaping air. For conventional and electrostatic applicators, this is for fan air.
- Dump — Turns on/off the dump valve used for flushing paint through the rotary atomizer.
- Cup Wash — Turns on/off the cup wash valve used for cleaning the inner and outer portions of the cup with solvent.
- Auxiliary 1 — Turns on/off the auxiliary 1 solenoid. Auxiliary solenoid must be configured as "PLC" on Setup Gun Screen 3.
- Auxiliary 2 — Turns on/off the auxiliary 2 solenoid. Auxiliary solenoid must be configured as "PLC" on Setup Gun Screen 3.
- Auxiliary 3 — Turns on/off the auxiliary 3 solenoid. Auxiliary solenoid must be configured as "PLC" on Setup Gun Screen 3.

**INPUT REGISTER 10: Gun Dynamic Atomizing Air / Inner Air Set Point**

The Gun Dynamic Atomizing Air / Inner Air Set Point register is used to update the target atomizing air/inner air set point. It can be changed at any time, and the system will immediately adjust to the new set point. A number between 7 and 99 can be written to this register. Units of this register are PSI.

**NOTE:** Active preset has to be equal to the Dynamic Preset 0 for value to take effect.

**INPUT REGISTER 11: Gun Dynamic Fan Air / Outer Air Set Point**

The Gun Dynamic Fan Air / Outer Air Set Point register is used to update the target fan air/outer air set point. It can be changed at any time, and the system will immediately adjust to the new set point. A number between 7 and 99 can be written to this register. Units of this register are PSI.

**NOTE:** Active preset has to be equal to the Dynamic Preset 0 for value to take effect.

**INPUT REGISTER 12: Gun Dynamic Turbine Speed Set Point**

The Gun Dynamic Turbine Speed Set Point register is used to update the target turbine speed set point. It can be changed at any time, and the system will immediately adjust to the new set point. A number between 10 and 60 can be written to this register. The value only accepted if the current preset is equal to 0 (Dynamic Preset). Units of this register are kRPM.

**NOTE:** Active preset has to be equal to the Dynamic Preset 0 for value to take effect.

**INPUT REGISTER 13: Gun Dynamic Voltage Set Point**

The Gun Dynamic Voltage Set Point register is used to update the target electrostatic voltage set point. It can be changed at any time, and the system will immediately adjust to the new set point. A number between 0 and 100 can be written to this register (values 1-9 default to 10). Units of this register are kV.

**NOTE:** Active preset has to be equal to the Dynamic Preset 0 for value to take effect.

**INPUT REGISTER 14: Gun Dynamic Current Set Point**

The Gun Dynamic Current Set Point register is used to update the target electrostatic current set point. It can be changed at any time, and the system will immediately adjust to the new set point. A number between 0 and 150 can be written to this register. Units of this register are  $\mu$ A.

**NOTE:** Active preset has to be equal to the Dynamic Preset 0 for value to take effect.

**INPUT REGISTER 15: Gun Trigger**

The Gun Trigger register is used to signal ProMix PD2K Integrated when the automatic applicator should be or is triggered.

- Write a value of '1' to signal that the applicator is triggered.
- Write a value of '0' to signal that the applicator is NOT triggered.

Bit	Name
0	Gun 1
1	Gun 2*
2	Gun 3*

\* Multiple applicator triggers are only supported with Gun Type: AirPro Auto, G40 Auto, and AirPro EFX.

**NOTE:** This register is used only if the Gun Trigger is set to 'Network' via ADM Screen 5 and Gun Screen 1 on the ADM. If it is set to 'Discrete' or 'Local' this register is ignored and applicator trigger is handled via the discrete input or softkey entry.

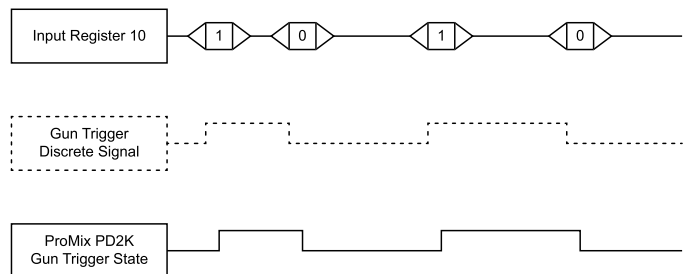

Figure 6 Gun Trigger Timing (Network and Discrete Signals Shown)

**INPUT REGISTER 16: Electrostatic Trigger**

The Electrostatic Trigger register is used to signal the ProMix PD2K Integrated to enable electrostatics.

**NOTE:** Robot should be located in a safe position to enable electrostatics. Arc detection is not enabled until blanking time is expired.

- Write a value of '1' to enable electrostatics.
- Write a value of '0' to disable electrostatics.

**NOTE:** This register is used only if the Electrostatic Trigger is set to 'Network' via Gun Screen 1 on the ADM. If it is set to 'Discrete' or 'Local' this register is ignored and applicator trigger is handled via the discrete input or softkey entry.

**INPUT REGISTERS 17 – 21: DCS Command Structure**

See [Dynamic Command Description, page 63](#).

**Network Input Data Map (Write Only)**

Network Input ID	Modbus Register	Parameter Name	Data Type	Units	Range
0000	40400	System Mode Command	uint32	NONE	0 = No OP 1 = Power Pumps 2 = Remote Stop 3 = Color Change 4 = Mix Fill 5 = Mix 6 = Purge A 7 = Purge B 8 = Standby 9 = Purge Standard 10 = Purge (Inactive Gun) 11 = Solvent Push
0001	40402	Pump Flush Sequence #/Prime Material #	uint32	NONE	1 - 5, 1 - 34
0002	40404	Flush/Prime Pump Command	uint32	NONE	0 = No OP 1 = Flush Pump 1 2 = Prime Pump 1 3 = Flush Pump 2 4 = Prime Pump 2 5 = Flush Pump 3 6 = Prime Pump 3 7 = Flush Pump 4 8 = Prime Pump 4 9 = Fill Line 10 = Flush Line 11 = Stop Line Fill/Flush
0003	40406	Mix (Pump 1) Control Set Point	uint32	cc/min or PSI	1 - 1600
0004	40408	Goto Recipe Number	uint32	NONE	0, 1 - 60
0005	40410	Clear Active Alarm	uint32	NONE	1 = Clear Active Alarm
0006	40412	Job Complete	uint32	NONE	1 = Trigger job complete

Operation Using a Programmable Logic Controller (PLC)

Network Input ID	Modbus Register	Parameter Name	Data Type	Units	Range
0007	40414	Gun Mode Command	uint32	NONE	0 = No Op 1 = Power 2 = Remote Stop 3 = Idle 4 = Spray 5 = Purge
0008	40416	Gun Goto Preset Number	uint32	NONE	0, 1 - 98
0009	40418	Gun Air Control Solenoids	uint32	NONE	bit 0 = Atomizing Air / Inner Air bit 1 = Fan Air / Outer Air bit 2 = Paint Trigger 1 bit 3 = Auxiliary 1 / Paint Trigger 2* / Dump** bit 4 = Auxiliary 2 / Paint Trigger 3* / Cup Wash** bit 5 = Auxiliary 3 * = Multiple applicator triggers are only supported with Gun Type: AirPro Auto, G40 Auto, and AirPro EFX. ** = When Gun Type = ProBell, Dump valve is mapped to bit 3 and Cup Wash is mapped to bit 4.
0010	40420	Gun Dynamic Shaping Air One Set Point	uint32	PSI	0 - 99
0011	40422	Gun Dynamic Shaping Air Two Set Point	uint32	PSI	0 - 99
0012	40424	Gun Dynamic Turbine Speed Set Point	uint32	KRPM	10 - 60
0013	40426	Gun Dynamic Voltage Set Point	uint32	kV	0, 10 - 100 (1 - 9 not valid)
0014	40428	Gun Dynamic Current Set Point	uint32	μA	0 - 150
0015	40430	Gun Trigger	uint32	NONE	bit 0 = Gun 1 bit 1 = Gun 2* bit 2 = Gun 3* * = Multiple applicator triggers are only supported with Gun Type: AirPro Auto, G40 Auto, and AirPro EFX.

Operation Using a Programmable Logic Controller (PLC)

Network Input ID	Modbus Register	Parameter Name	Data Type	Units	Range
0016	40432	Gun Electrostatic Trigger	uint32	NONE	0 = Electrostatics Off 1 = Electrostatics On
0017	40900	Command Argument 0	uint32	NONE	N/A
0018	40902	Command Argument 1	uint32	NONE	N/A
0019	40904	Command Argument 2	uint32	NONE	N/A
0020	40906	Command Argument 3	uint32	NONE	N/A
0021	40908	Command Argument 4	uint32	NONE	N/A
0022	40910	Command Argument 5	uint32	NONE	N/A
0023	40912	Command Argument 6	uint32	NONE	N/A
0024	40914	Command	uint32	NONE	See Command Table
<div style="display: flex; justify-content: space-between; align-items: center;"> <div style="background-color: #cccccc; width: 100px; height: 15px; margin-right: 5px;"></div> <span>These registers are not used.</span> <div style="background-color: #4f81bd; width: 100px; height: 15px; margin-left: 100px; margin-right: 5px;"></div> <span>DCS Register</span> </div>					

## Operation Flow Charts

### Purge Mode Sequence

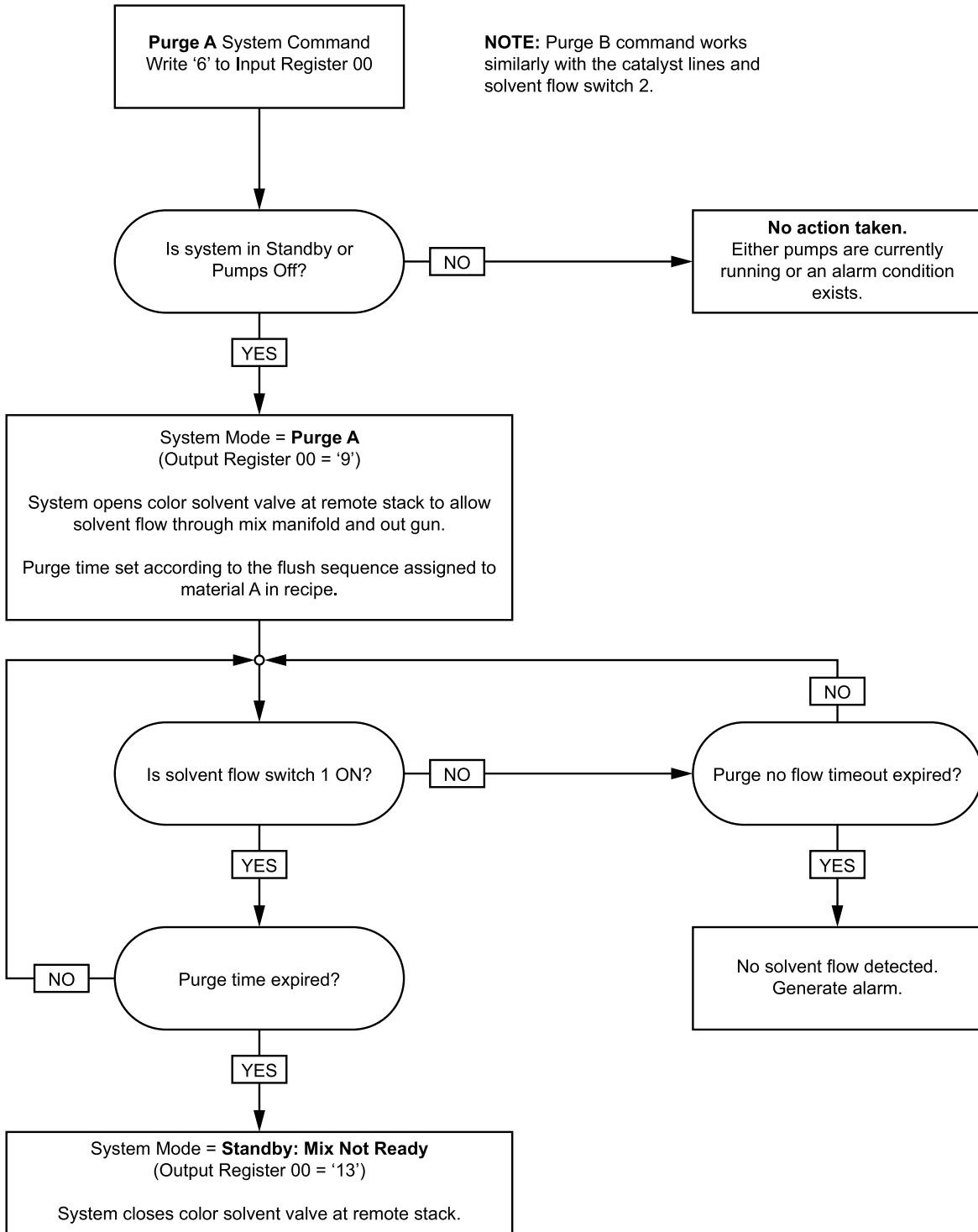

### Purge Recipe Sequence

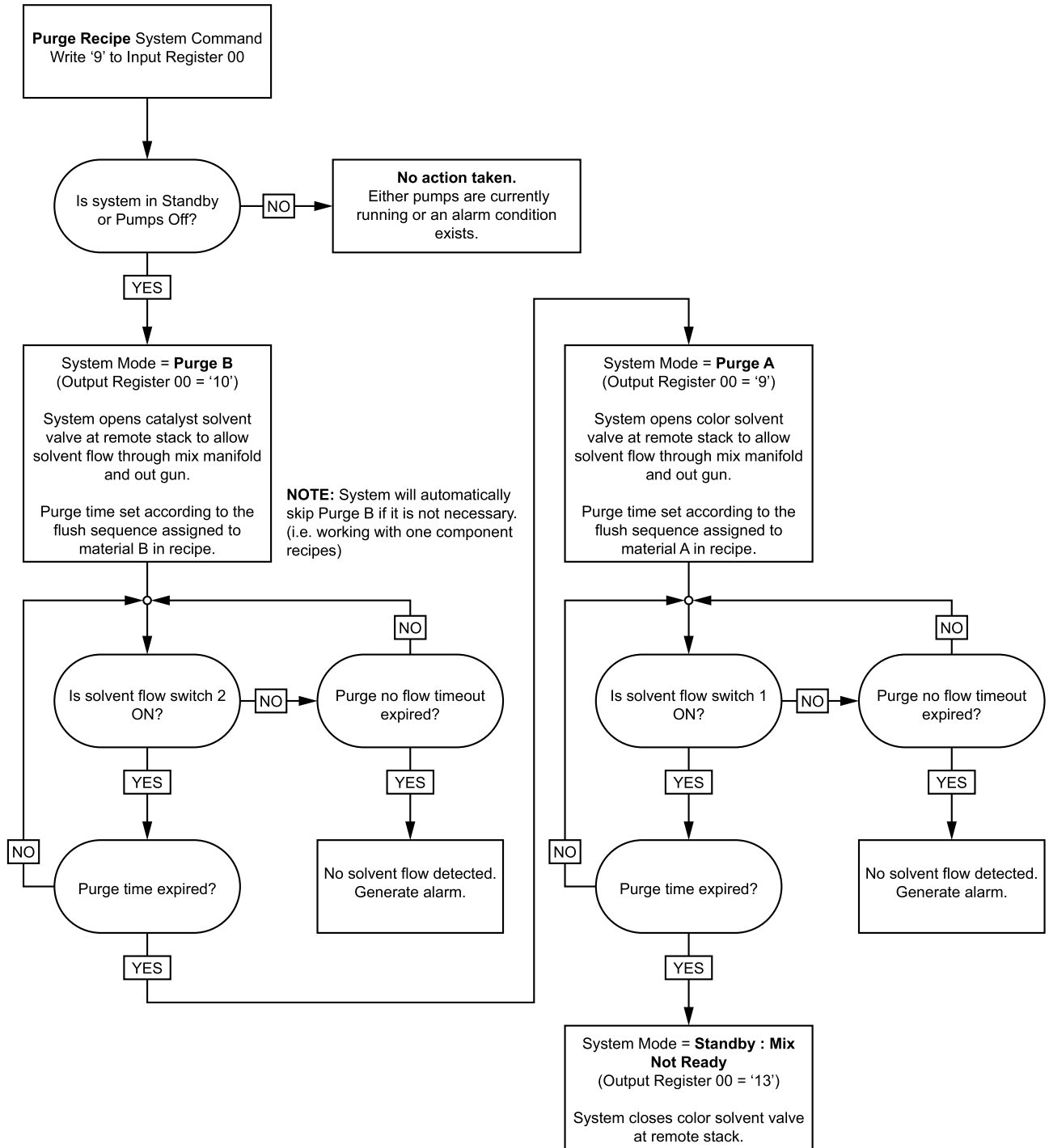

### Purge (Inactive) Sequence

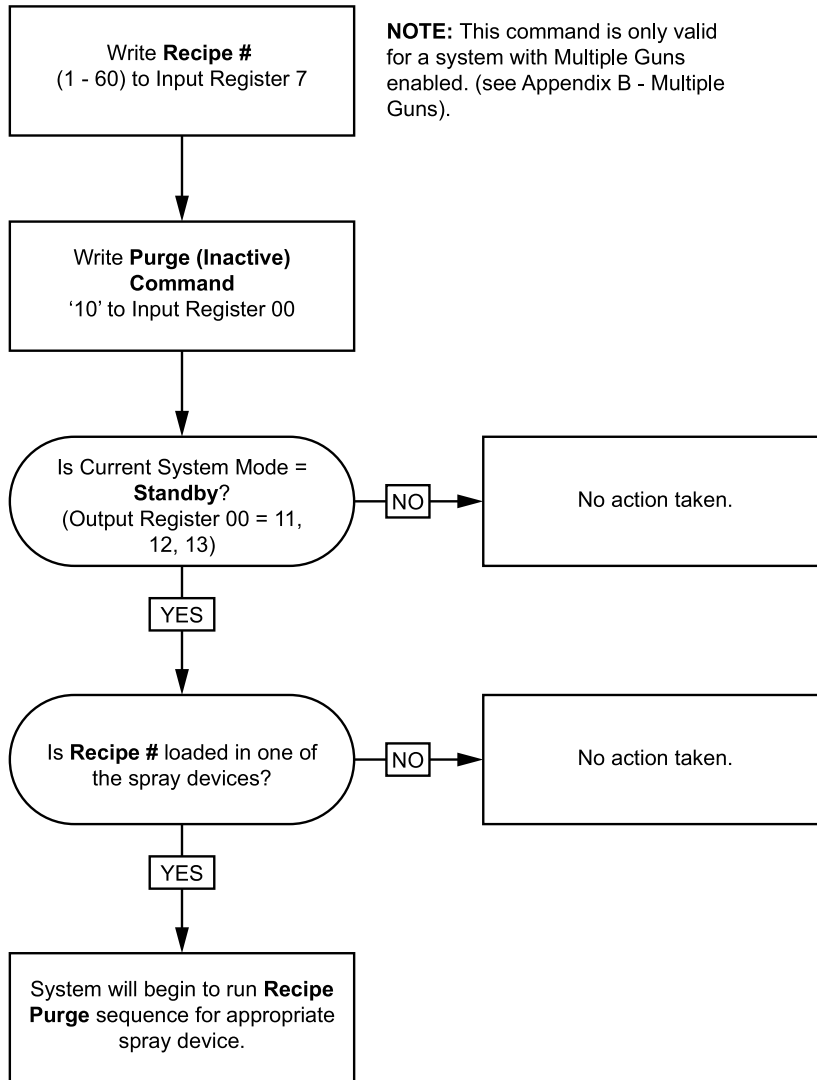



### Inactive Pump Flush and Prime Sequences

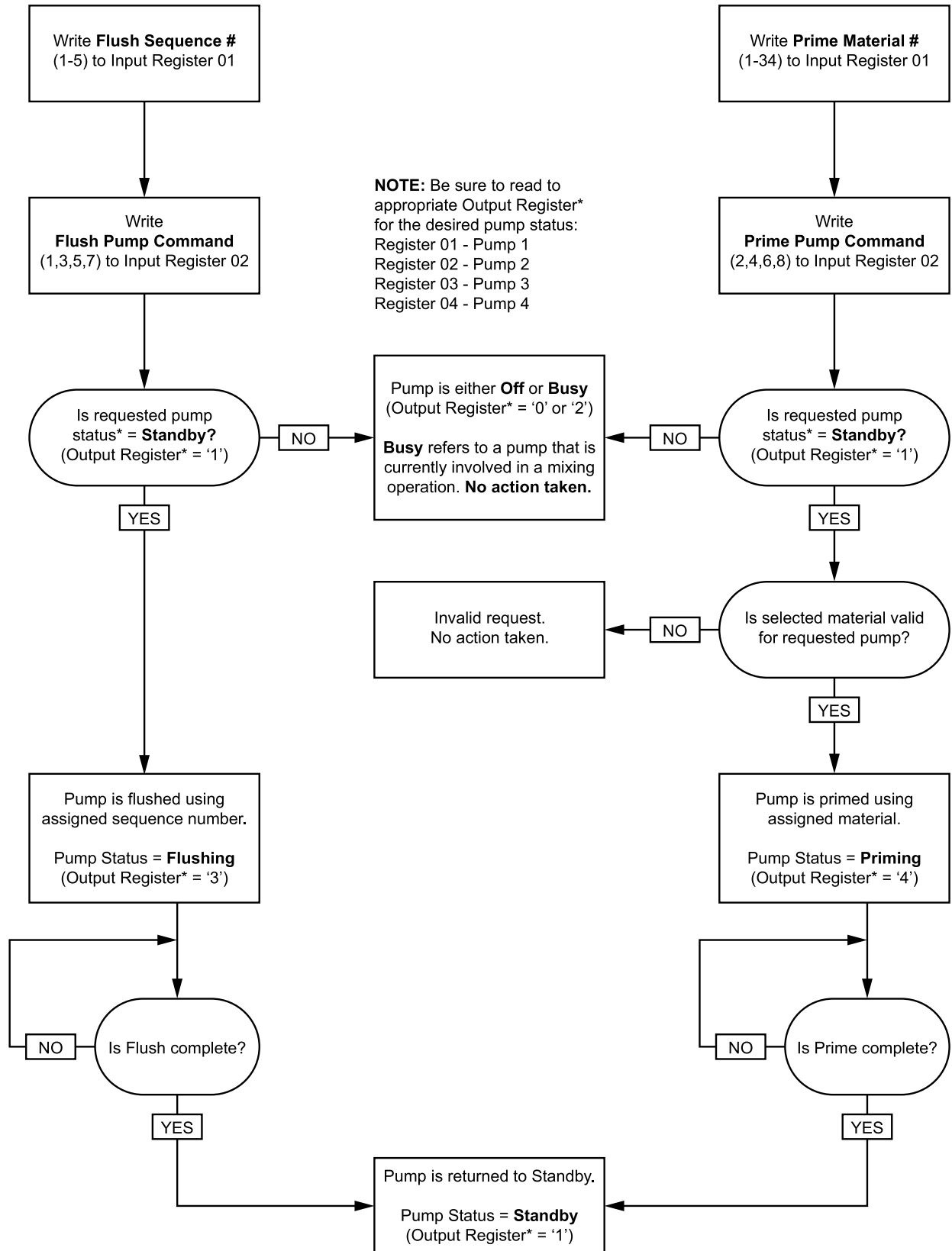

### Line Fill and Flush Sequences

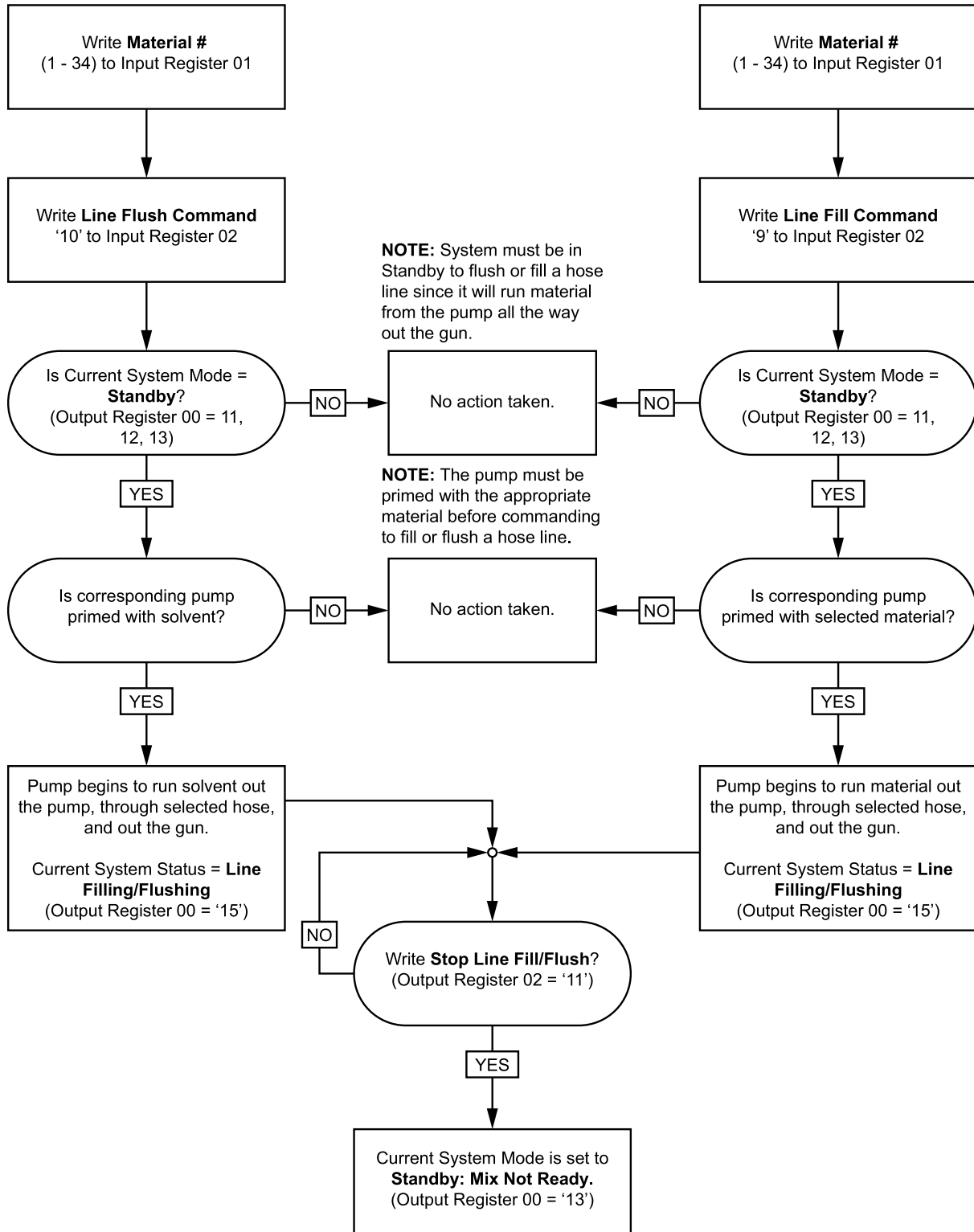

### Color Change Sequence

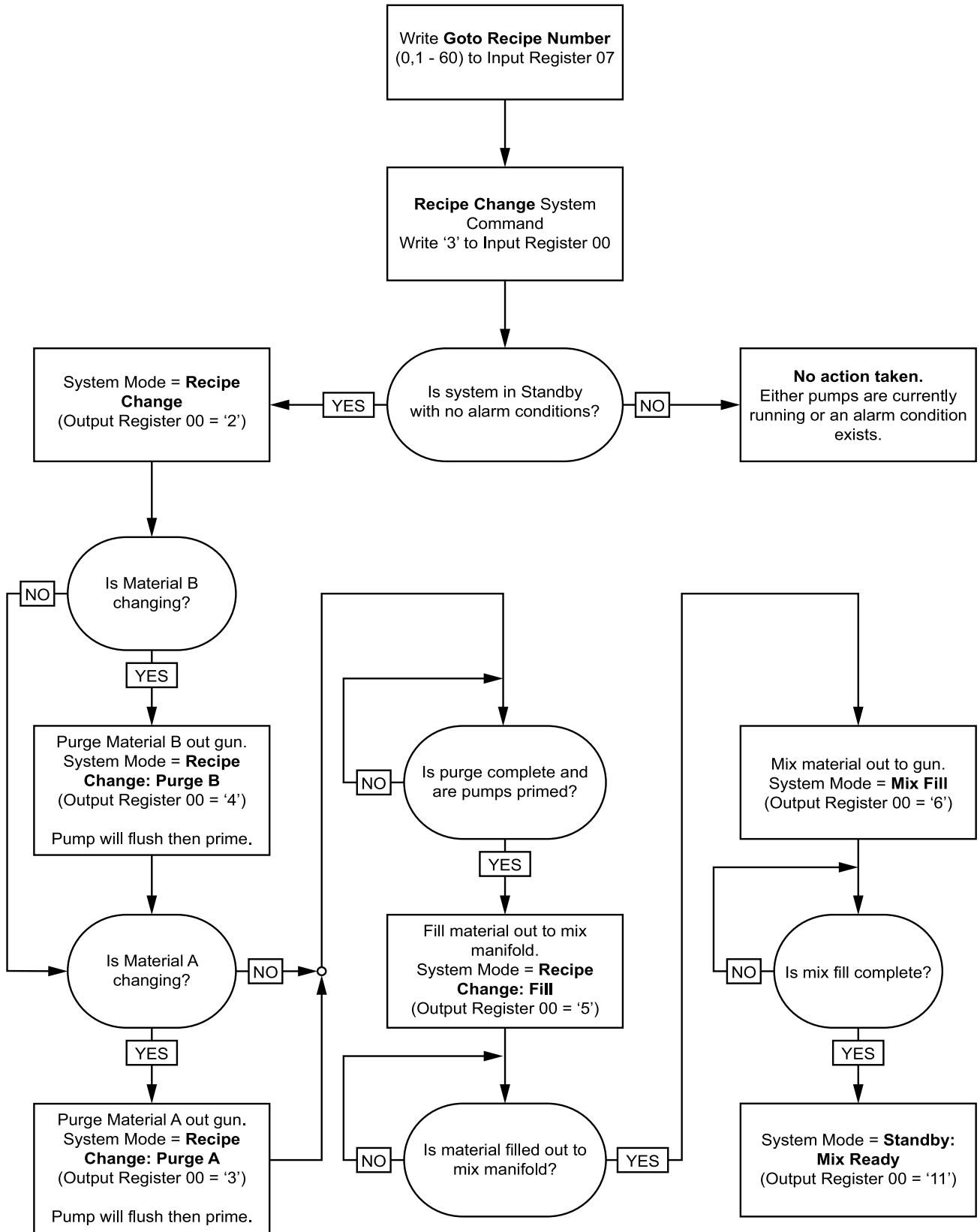

### Recipe Change Alarm Recovery Sequences

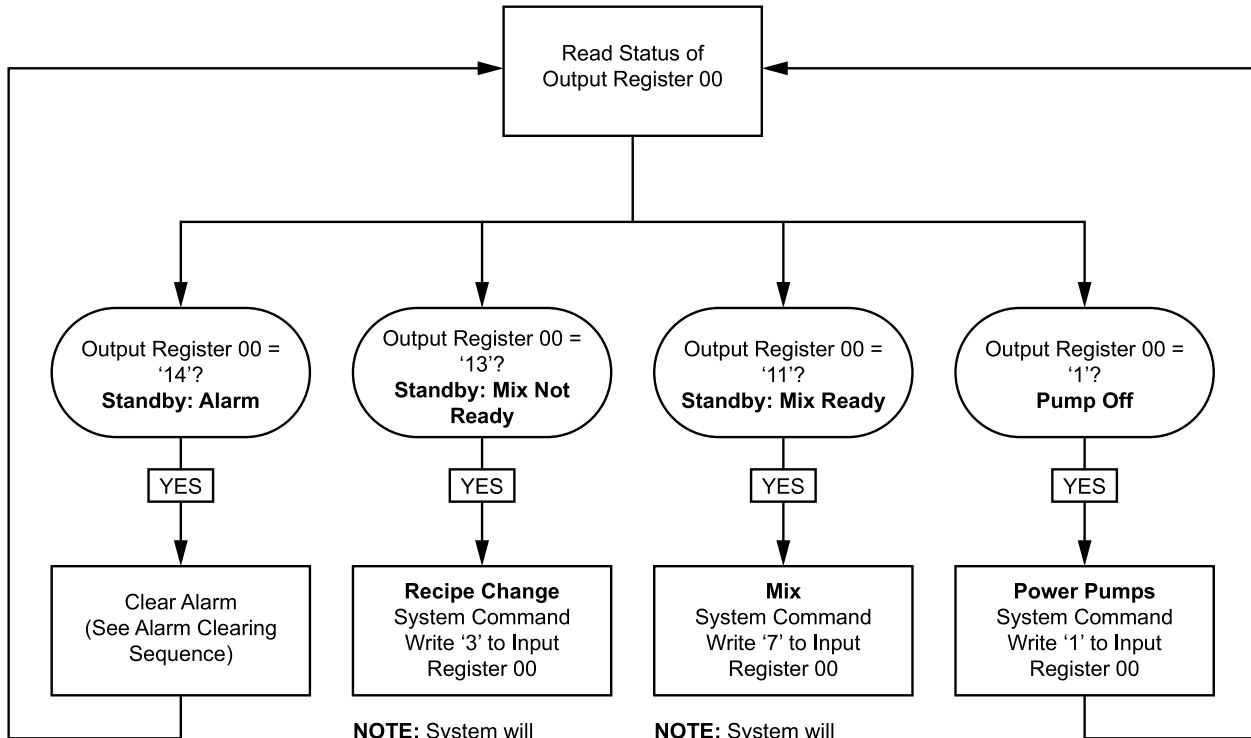

**NOTE:** System will automatically run through necessary recipe change steps based on it's current state. If **Goto Recipe Number** has not changed, it does not have to be rewritten here.

**NOTE:** System will automatically perform Mix Fill if it needs to be completed before transitioning directly into Mix mode.

### Mixing Sequence

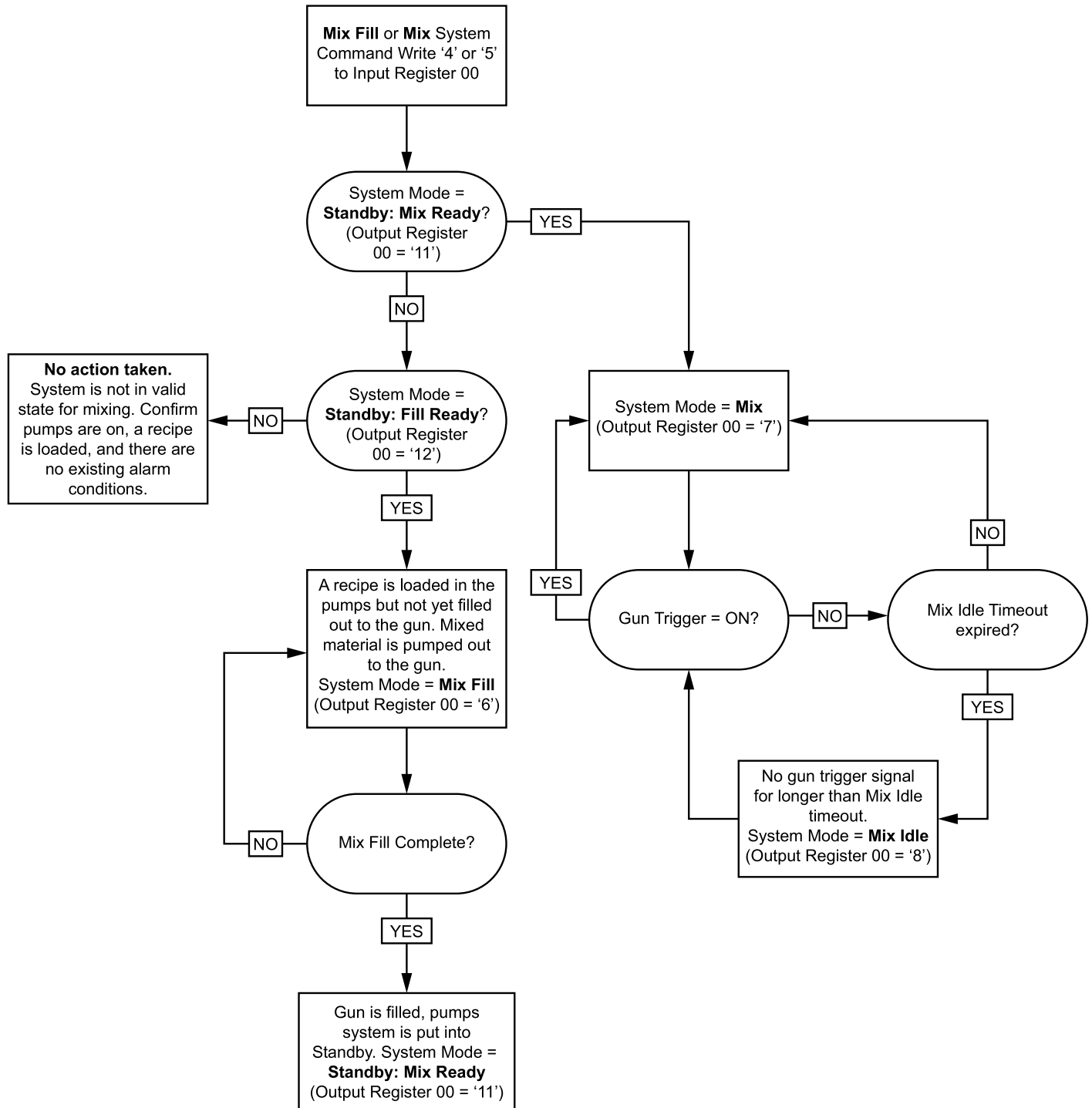

### Alarm Clearing Sequence

**NOTE:** Some alarms put the system in Standby, more serious alarms shut the pumps down. If an alarm condition is active the System Mode will either be **Pump Off** or **Standby: Alarm**. (Output Register 00 = '1' or '14')

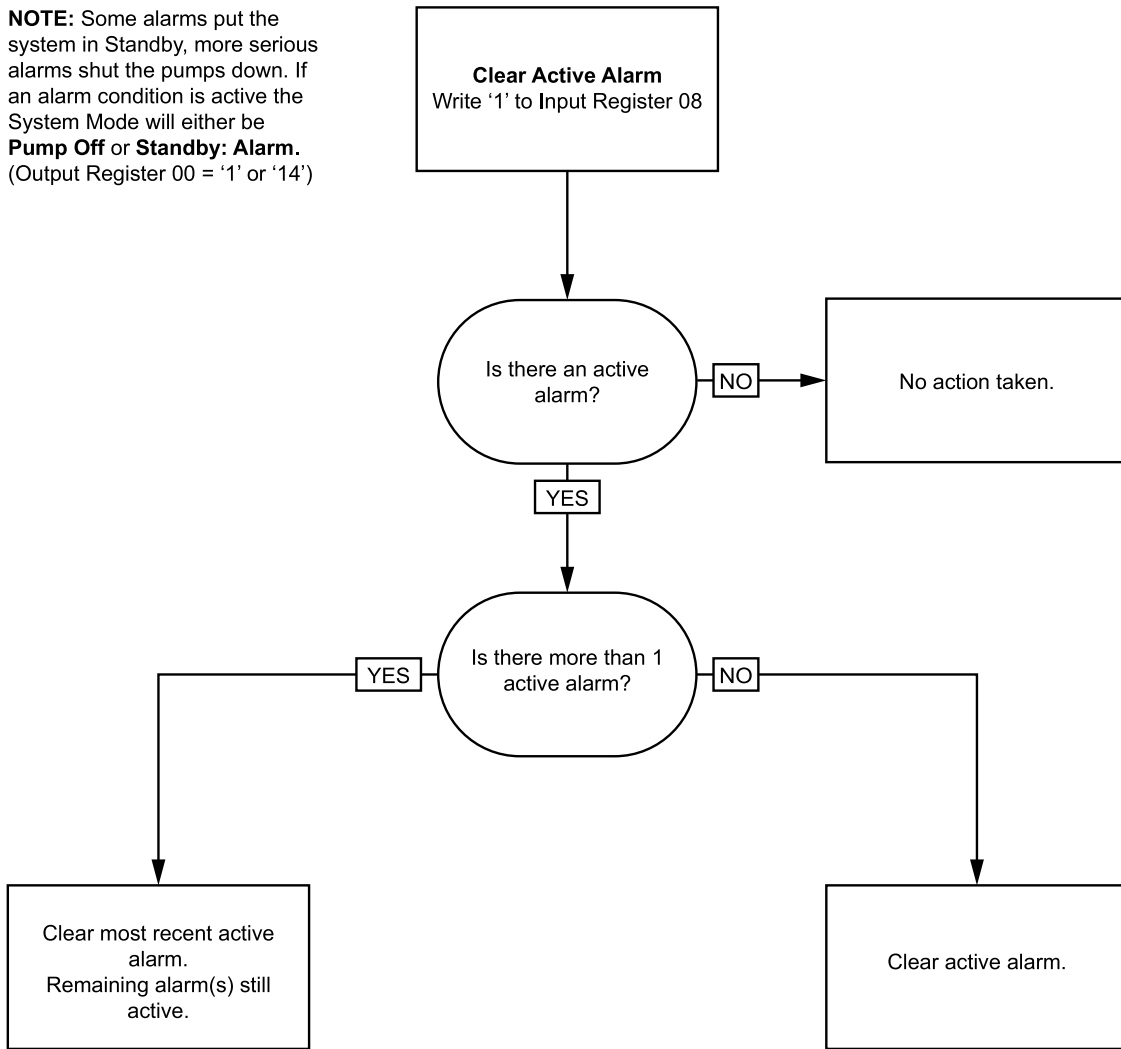

**NOTE:** If more than 1 active alarm exists a repeated write of '1' to Input Register 08 is required for each.

## Network Communication - Dynamic Command Structure (DCS)

### Dynamic Command Description

The Dynamic Command Structure (DCS) is used to 1) access data that requires some form of argument(s) or 2) consolidate data that requires multiple registers. The DCS uses a static set of network communication input and output registers (see [Network Input Data Map \(Write Only\)](#), page 51 and [Network Output Data Map \(Read Only\)](#), page 42).

Use the following sequence for the DCS.

1. Write the appropriate command arguments to INPUT REGISTERS 17 – 23. These commands may be written sequentially or sent all at once.
2. Once all arguments have been passed, write the command ID to INPUT REGISTER 24.
3. The ProMix PD2K will respond to a valid command by writing a 2 (Acknowledge) to OUTPUT REGISTER 30.
4. The ProMix PD2K will write appropriate return values to OUTPUT REGISTERS 31 – 38.

#### ProMix PD2K Inputs (PLC Outputs)

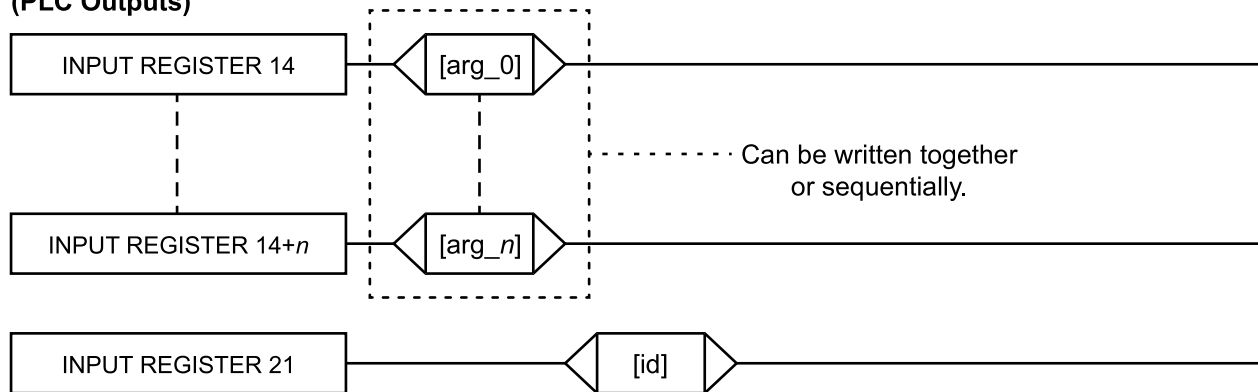

#### ProMix PD2K Outputs (PLC Inputs)

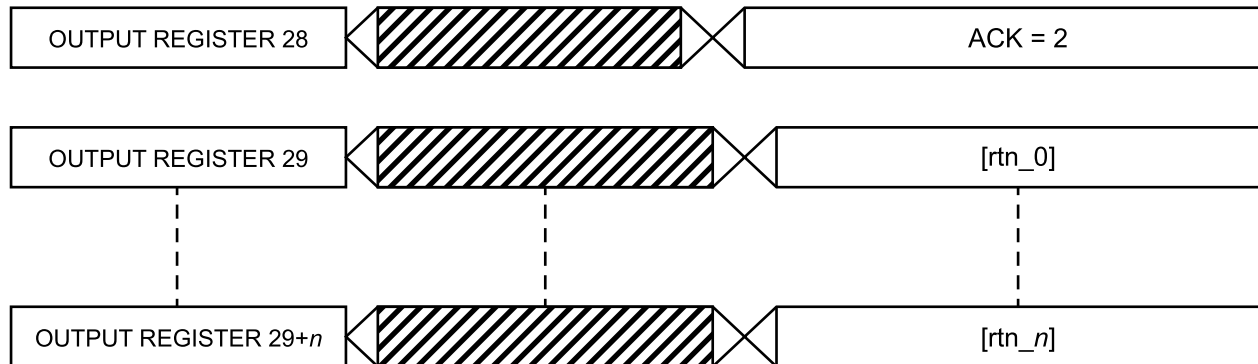

Figure 7 Dynamic Command Structure Timing

## List of DCS Commands

Table 6 Dynamic Commands with Command ID

ID	Command
0	No OP
1	Write User ID
2	Write Recipe
3	Write Flush Sequence
4	Write Fluid Control Mode
5	Write Mix Fill Set Point
10	Read User ID
11	Read Recipe
12	Read Flush Sequence
13	Read Fluid Control Mode
14	Read Job Info
15	Read Alarm Info
16	Read Event Info
17	Read Recipe Potlife
19	Read Mix Fill Set Point
20	Read Pump Material
21	Read Gun Contents
22	Read Grand Totals
40	Write Preset
50	Read Preset



## Write User ID

The Write User ID command allows users to assign a User ID to a Job Log. See [Usage Screen, page 94](#), for more details on Job Log and User ID. The User ID can be up to ten ASCII characters in length and is packaged as three little endian segments of ASCII characters. The return registers will echo the arguments received.

**NOTE:** The User ID character string must be terminated with a null character.

*Example: Write a User ID of "John Doe" to the ProMix PD2K.*

DCS Register	Parameter Description	Data Type	Units	Value	Range
DCS Command	Write User ID	uint32	NONE	1	0 - 21
Argument 0	User ID characters [3:0] (ASCII)	uint32	NONE	0x6E686F4A = ['n', 'h', 'o', 'J']	N/A
Argument 1	User ID characters [7:4] (ASCII)	uint32	NONE	0x656F4420 = ['e', 'o', 'D', ' ']	N/A
Argument 2	User ID characters [9:8] (ASCII)	uint32	NONE	0x0 = [null]	N/A
Acknowledge	Command Acknowledged	uint32	NONE	2 = ACK	0 - 4
Return 0	User ID characters [3:0] (ASCII)	uint32	NONE	0x6E686F4A	N/A
Return 1	User ID characters [7:4] (ASCII)	uint32	NONE	0x656F4420	N/A
Return 2	User ID characters [9:8] (ASCII)	uint32	NONE	0x0	N/A

## Write Recipe

The Write Recipe command allows users to configure an entire recipe remotely. See [Recipe Screen, page 104](#), for more details on recipes and recipe parameters. The return registers will echo the arguments received.

**NOTE:** The recipe must be enabled via the ADM before it can be loaded for mixing.

*Example: Configure Recipe 6 for Color = 2, Catalyst = 1, Color Flush Sequence = 2, Catalyst Flush Sequence = 3, Mix Ratio Set Point = 1.50:1, and Potlife = 10 minutes.*

DCS Register	Parameter Description	Data Type	Units	Value	Range
DCS Command	Write Recipe	uint32	NONE	2	0 - 21
Argument 0	Recipe Number	uint32	NONE	6	0 - 60
Argument 1	Material A	uint32	NONE	2	0 - 30
Argument 2	Material B	uint32	NONE	31	0, 31 - 34
Argument 3	Material A Flush Sequence	uint32	NONE	2	1 - 5
Argument 4	Material B Flush Sequence	uint32	NONE	3	1 - 5
Argument 5	Mix Ratio Set Point	uint32	NONE	150 = 1.50:1	0 - 5000
Argument 6	Potlife Time Set Point	uint32	min	10	0 - 999
Acknowledge	Command Acknowledged	uint32	NONE	2 = ACK	0 - 4
Return 0	Recipe Number	uint32	NONE	6	0 - 60
Return 1	Material A	uint32	NONE	2	0 - 30
Return 2	Material B	uint32	NONE	31	0, 31 - 34
Return 3	Material A Flush Sequence	uint32	NONE	2	1 - 5
Return 4	Material B Flush Sequence	uint32	NONE	3	1 - 5
Return 5	Mix Ratio Set Point	uint32	NONE	150	0 - 5000
Return 6	Potlife Time Set Point	uint32	min	10	0 - 999
Return 7	Recipe Gun Assignment*	uint32	NONE	1	1 - 3
* Only used when Multiple Guns is enabled.					

## Write Flush Sequence

The Write Flush Sequence command allows users to configure an entire flush sequence remotely. See [Flush Screen, page 106](#), for more details of flush sequence parameters. The return registers will echo the arguments received.

*Example: Configuring Flush Sequence 4 for Gun Purge Time = 10 sec, Initial Flush Volume = 125 cc, Final Flush Volume = 250 cc, Wash Cycles = 1, Strokes per Cycle = 2.*

DCS Register	Parameter Description	Data Type	Units	Value	Range
DCS Command	Write Flush Sequence	uint32	NONE	3	0 - 21
Argument 0	Flush Sequence #	uint32	NONE	4	1 - 5
Argument 1	Gun Purge Time	uint32	NONE	10	0 - 999
Argument 2	Initial Flush Volume	uint32	NONE	125	0 - 9999
Argument 3	Final Flush Volume	uint32	NONE	250	0 - 9999
Argument 4	# Wash Cycles	uint32	NONE	1	0 - 99
Argument 5	Strokes per Wash Cycle	uint32	NONE	2	0 - 99
Acknowledge	Command Acknowledged	uint32	NONE	2 = ACK	0 - 4
Return 0	Flush Sequence #	uint32	NONE	4	1 - 5
Return 1	Gun Purge Time	uint32	sec	10	0 - 999
Return 2	Initial Flush Volume	uint32	cc	125	0 - 9999
Return 3	Final Flush Volume	uint32	cc	250	0 - 9999
Return 4	# Wash Cycles	uint32	NONE	1	0 - 99
Return 5	Strokes per Wash Cycle	uint32	NONE	2	0 - 99

## Write Fluid Control Mode

The Write Fluid Control Mode command allows users to remotely change Fluid Control between 'Flow' and 'Pressure'. See [System Screen 5, page 102](#), for more details on Fluid Control mode. The return registers will echo the arguments received.

**NOTE:** The Fluid Control mode should be changed only when the system is in Standby or when the pumps are powered off. Do not change Fluid Control modes during a mix operation.

*Example: Change to Flow Control mode.*

DCS Register	Parameter Description	Data Type	Units	Value	Range
DCS Command	Write Fluid Control Mode	uint32	NONE	4	0 - 21
Argument 0	Fluid Control Mode	uint32	NONE	0 = Flow Mode	0 = Flow 1 = Pressure
Acknowledge	Command Acknowledged	uint32	NONE	2 = ACK	0 - 4
Return 0	Fluid Control Mode	uint32	NONE	0	0 = Flow 1 = Pressure

## Write Mix Fill Set Point

The Write Mix Fill Set Point command allows for setting an alternate control set point to decrease the time it takes to fill the line with mixed material. See [System Screen 5, page 102](#), for more details on Mix Fill Set Point. The return registers will echo the arguments received.

**NOTE:** The Mix Fill Set Point units depend on the selected Fluid Control Mode of the system. If the Fluid Control Mode is 'Flow', the units will be cc/min. If the Fluid Control Mode is 'Pressure', the units will be PSI. If the value is zero, this set point will be ignored.

*Example: Configuring a flow control system to a Mix Fill Set Point of 300 cc/min.*

DCS Register	Parameter Description	Data Type	Units	Value	Range
DCS Command	Write Mix Fill Set Point	uint32	NONE	5	0 - 21
Argument 0	Mix Fill Set Point	uint32	cc/min or PSI	300	1 - 1600 (cc/min) 1 - 1500 (PSI) 0 := Disabled
Acknowledge	Command Acknowledged	uint32	NONE	2 = ACK	0 - 4
Return 0	Mix Fill Set Point	uint32	cc/min or PSI	300	1 - 1600 (cc/min) 1 - 1500 (PSI) 0 := Disabled

## Read User ID

The Read User ID command reads back the current User ID. See [Usage Screen, page 94](#), for more details on Job Log and User ID. The User ID can be up to ten ASCII characters in length and is packaged as three little endian segments of ASCII characters. No arguments are required.

*Example: Read User ID that is currently "John Doe".*

DCS Register	Parameter Description	Data Type	Units	Value	Range
DCS Command	Read User ID	uint32	NONE	10	0 - 21
Acknowledge	Command Acknowledged	uint32	NONE	2 = ACK	0 - 4
Return 0	User ID characters [3:0] (ASCII)	uint32	NONE	0x6E686F4A = ['n', 'h', 'o', 'J']	N/A
Return 1	User ID characters [7:4] (ASCII)	uint32	NONE	0x656F4420 = ['e', 'o', 'D', ' ']	N/A
Return 2	User ID characters [9:8] (ASCII)	uint32	NONE	0x0 = [null]	N/A

## Read Recipe

The Read Recipe command returns all configured recipe parameters for a desired recipe number. The number of the recipe to be read is the only argument.

*Example: Read Recipe 5 data as it is currently configured with Color = 3, Catalyst = 2 (32), Color Flush Sequence = 1, Catalyst Flush Sequence = 4, Mix Ratio Set Point = 3.25:1, and Potlife = 35 min.*

DCS Register	Parameter Description	Data Type	Units	Value	Range
DCS Command	Read Recipe	uint32	NONE	11	0 - 21
Argument 0	Recipe #	uint32	NONE	5	0 - 60
Acknowledge	Command Acknowledged	uint32	NONE	2 = ACK	0 - 4
Return 0	Recipe #	uint32	NONE	5	0 - 60
Return 1	Material A	uint32	NONE	3	0 - 30, 61
Return 2	Material B	uint32	NONE	32	0, 31 - 34, 61
Return 3	Material A Flush Sequence	uint32	NONE	1	1 - 5
Return 4	Material B Flush Sequence	uint32	NONE	4	1 - 5
Return 5	Mix Ratio Set Point	uint32	NONE	325	0 - 5000
Return 6	Potlife Time Set Point	uint32	min	35	0 - 999

## Read Flush Sequence

The Read Flush Sequence command returns all configured parameters for a desired flush sequence. The number of the flush sequence to be read is the only argument.

*Example: Read Flush Sequence 1 as it is currently configured with Gun Purge Time = 20 sec, Initial Flush Volume = 0 cc, Final Flush Volume = 500 cc, Wash Cycles = 2, and Strokes per Cycle = 1.*

DCS Register	Parameter Description	Data Type	Units	Value	Range
DCS Command	Read Flush Sequence	uint32	NONE	12	0 - 21
Argument 0	Flush Sequence #	uint32	NONE	1	1 - 5
Acknowledge	Command Acknowledged	uint32	NONE	2 = ACK	0 - 4
Return 0	Flush Sequence #	uint32	NONE	1	1 - 5
Return 1	Gun Purge Time	uint32	sec	20	0 - 999
Return 2	Initial Flush Volume	uint32	cc	0	0 - 9999
Return 3	Final Flush Volume	uint32	cc	500	0 - 9999
Return 4	# Wash Cycles	uint32	NONE	2	0 - 99
Return 5	Strokes per Wash Cycle	uint32	NONE	1	0 - 99

## Read Fluid Control Mode

The Read Fluid Control Mode command is used to read the current Fluid Control mode of the system is currently operating under. No arguments are required.

*Example: Read Fluid Control as currently set to Pressure mode.*

DCS Register	Parameter Description	Data Type	Units	Value	Range
DCS Command	Read Fluid Control Mode	uint32	NONE	13	0 - 21
Acknowledge	Command Acknowledged	uint32	NONE	2 = ACK	0 - 4
Return 0	Fluid Control Mode	uint32	NONE	1 = Pressure	0 = Flow 1 = Pressure

## Read Job Info

The Read Job Info command is used to access data from any of the most recent 200 job logs. The argument is the *chronological index* of the job log, where 0 is the most recent job log and 199 is the 200<sup>th</sup> most recent.

The date is returned as four-byte packet with each byte holding a two-digit value for (from MSB to LSB) year, month, day, and day of the week (Monday = 01).

The time is returned as a three-byte packet with each byte holding a two-digit value. Starting from the MSB, the first byte can be ignored, then hour, minute, and second.

**NOTE:** The argument is an index not a job number. The actual job number will, however, be one of the returned parameters. These records will match what is reported on the Jobs screen of the ADM.

(See [Usage Screen](#), page 94, for more details on Job Log)

Operation Using a Programmable Logic Controller (PLC)

Example: Read back the most recent job log, job 25, which ran recipe 2 for a total of 1234 cc's of material under User ID "John Doe". The job was logged on Thursday May 29, 2014 at 11:22:14 AM.

DCS Register	Parameter Description	Data Type	Units	Value	Range
DCS Command	Read Job Info	uint32	NONE	14	0 - 21
Argument 0	Job Index	uint32	NONE	0	0 - 199
Acknowledge	Command Acknowledged	uint32	NONE	2 = ACK	0 - 4
Return 0	Job Date	uint32	[YY:MM:DD: :DW]	0x0E051D04 = [14:05:29:04]	N/A
Return 1	Job Time	uint32	[xx:HH:MM: :SS]	0x0B160E = [11:22:14]	N/A
Return 2	Job Number	uint32	NONE	25	0 - 9999
Return 3	Recipe #	uint32	NONE	2	0 - 60
Return 4	A+B Volume	uint32	cc	1234	N/A
Return 5	User ID [3:0] (ASCII)	uint32	NONE	0x6E686F4A = ['n', 'h', 'o', 'J']	N/A
Return 6	User ID [7:4] (ASCII)	uint32	NONE	0x656F4420 = ['e', 'o', 'D' ' ']	N/A
Return 7	User ID [9:8] (ASCII)	uint32	NONE	0	N/A



## Read Alarm Info

The Read Alarm Info command allows remote access to any of the last 200 alarms logged by the ProMix PD2K. The argument is the *chronological index* of the alarm log, where 0 is the most recent alarm and 199 is the 200<sup>th</sup> most recent.

The date is returned as a four-byte packet with each byte holding a two-digit value for (from MSB to LSB) year, month, day, and day of the week (Monday = 01).

The time is returned as a three-byte packet with each byte holding a two-digit value. Starting from the MSB, the first byte can be ignored, then hour, minute, and second.

The alarm code is a four-character little endian ASCII string

See [System Errors, page 140](#), for more details on these Event Types.

An example decoding algorithm is provided below.

*Example: Read back the second most recent alarm, which was a Position Pump 1 (DK01) recorded on Tuesday June 3, 2014 at 8:11 AM.*

DCS Register	Parameter Description	Data Type	Units	Value	Range
DCS Command	Read Alarm Info	uint32	NONE	15	0 - 21
Argument 0	Alarm Index	uint32	NONE	1	0 - 199
Acknowledge	Command Acknowledged	uint32	NONE	2 = ACK	0 - 4
Return 0	Alarm Date	uint32	[YY:MM:DD:DW]	0x0E060302 = [14:06:03:02]	N/A
Return 1	Alarm Time	uint32	[xx:HH:MM:SS]	0x080B0B = [08:11:11]	N/A
Return 2	Alarm Code Char[3:0]	uint32	NONE	0x31304B44 = ['1', '0', 'K', 'D']	N/A

### Example ASCII Character String Decode Algorithm:

```

character_str[0] = Return_2 & 0xFF;
character_str[1] = (Return_2 >> 8) & 0xFF;
character_str[2] = (Return_2 >> 16) & 0xFF;
character_str[3] = (Return_2 >> 24) & 0xFF;
character_str[4] = '\0';
    
```

## Read Event Info

The Read Event Info command allows remote access to any of the last 200 events logged by the ProMix PD2K. The argument is the *chronological index* of the events log, where 0 is the most recent event and 199 is the 200<sup>th</sup> most recent.

The date is returned as a four-byte packet with each byte holding a two-digit value for (from MSB to LSB) year, month, day, and day of the week (Monday = 01).

The time is returned as a three-byte packet with each byte holding a two-digit value. Starting from the MSB, the first byte can be ignored, then hour, minute, and second.

The event code is a four-character little endian ASCII string.

The example decoding algorithm provided above for the Alarm Code may be used for Events equivalently.

*Example: Read back the fifth most recent event, which was a Setup Value(s) Changed (EC00) recorded on Tuesday June 3, 2014 at 8:11 AM.*

DCS Register	Parameter Description	Data Type	Units	Value	Range
DCS Command	Read Event Info	uint32	NONE	16	0 - 21
Argument 0	Event Number	uint32	NONE	4	0 - 199
Acknowledge	Command Acknowledged	uint32	NONE	2 = ACK	0 - 4
Return 0	Event Date	uint32	[YY:MM:DD-:DW]	0x0E060302 = [14:06:03:02]	N/A
Return 1	Event Time	uint32	[xx:HH:MM:SS]	0x080B0B = [08:11:11]	N/A
Return 2	Event Code Char[3:0]	uint32	NONE	0x30304345 = ['0', '0', 'C', 'E']	N/A

## Read Recipe Potlife Time

The Read Recipe Potlife Time command returns the remaining potlife time, in minutes, for a selected recipe if it is currently loaded and mixed. This command is particularly useful if Multiple Guns is enabled.

**NOTE:** This command will return 0xFFFFFFFF if there is no potlife time associated with the recipe or the timer has not started.

*Example: Read recipe 1 potlife time remaining that is currently "12 minutes".*

DCS Register	Parameter Description	Data Type	Units	Value	Range
DCS Command	Read Recipe Potlife Time	uint32	NONE	17	0 - 21
Argument 0	Recipe Number	uint32	NONE	1	1 - 60
Acknowledge	Command Acknowledged	uint32	NONE	2 = ACK	0 - 4
Return 0	Recipe Number	uint32	NONE	1	1 - 60
Return 1	Potlife Time Remaining	uint32	min	12	0 - 999

## Read Mix Fill Set Point

The Read Mix Fill Set Point command is used to read the current Mix Fill Set Point. See [System Screen 4, page 102](#), for more details on Mix Fill Set Point. No arguments are required.

**NOTE:** The Mix Fill Set Point units depend on the selected Fluid Control Mode of the system. If the Fluid Control Mode is 'Flow', the units will be cc/min. If the Fluid Control Mode is 'Pressure', the units will be PSI. If the value is zero, this set point will be ignored.

*Example: Read the Mix Fill Set Point, currently set to 350 cc/min.*

DCS Register	Parameter Description	Data Type	Units	Value	Range
DCS Command	Read Mix Fill Set Point	uint32	NONE	19	0 - 21
Acknowledge	Command Acknowledged	uint32	NONE	2 = ACK	0 - 4
Return 0	Mix Fill Set Point	uint32	cc/min or PSI	350	1 - 1600 (cc/min) 1 - 1500 (PSI) 0 := Disabled

## Read Pump Material

The Read Pump Material command returns the material number of the color or catalyst that is currently loaded in a user-specified pump.

**NOTE:** This command will return '0' if the pump is filled with solvent, or '61' if the material is unknown.

*Example: Read what material is loaded in pump 1, which is currently color 2.*

DCS Register	Parameter Description	Data Type	Units	Value	Range
DCS Command	Read Pump Material	uint32	NONE	20	0 - 21
Argument 0	Pump Number	uint32	NONE	1	1 - 4
Acknowledge	Command Acknowledged	uint32	NONE	2 = ACK	0 - 4
Return 0	Pump Number	uint32	NONE	1	1 - 4
Return 1	Material Number	uint32	NONE	2	0 - 34, 61

## Read Gun Contents

The Read Gun Contents command returns the recipe number of the mixed material that is currently loaded in a user-specified applicator. This command is used if Multiple Guns are enabled. See [Appendix B: Multiple Guns, page 171](#) .

**NOTE:** This command will return '0' if the applicator is filled with solvent, or '61' if the material is unknown.

*Example: Read what material is loaded in applicator 1, which is currently recipe 2.*

DCS Register	Parameter Description	Data Type	Units	Value	Range
DCS Command	Read Gun Contents	uint32	NONE	21	0 - 21
Argument 0	Gun Number	uint32	NONE	1	1 - 3
Acknowledge	Command Acknowledged	uint32	NONE	2 = ACK	0 - 4
Return 0	Gun Number	uint32	NONE	1	1 - 3
Return 1	Recipe Number	uint32	NONE	2	0 - 61

## Read Grand Totals

The Read Grand Totals command allows remote access to the material grand total volume data. No arguments are necessary for this command.

*Example: Read current Grand Total usage data. A = 132 gal, B = 128 gal, A+B = 260 gal, Solvent = 11 gal.*

DCS Register	Parameter Description	Data Type	Units	Value	Range
DCS Command	Read Grand Totals	uint32	NONE	22	0 - 22
Acknowledge	Command Acknowledged	uint32	NONE	2 = ACK	0 - 4
Return 0	Grand Total A Material	uint32	Gallons	132	0 – 4,294,967,295
Return 1	Grand Total B Material	uint32	Gallons	128	0 – 4,294,967,295
Return 2	Grand Total A+B	uint32	Gallons	260	0 – 4,294,967,295
Return 3	Grand Total Solvent	uint32	Gallons	11	0 – 4,294,967,295

## Write Preset

The Write Preset command allows users to configure an entire preset remotely. The return registers will echo the arguments received.

*Example: Read Fluid Control as currently set to Pressure mode.*

DCS Register	Parameter Description	Data Type	Units	Value	Range
DCS Command	Write Preset	uint32	NONE	40	0 - 50
Argument 0	Preset Number	uint32	NONE	1	0 - 99
Argument 1	Flow / Pressure Set Point	uint32	cc/min or PSI	300	1 - 1600 (cc/min) 1 - 1500 (PSI) 0 = Disabled
Argument 2	Atomizing Air Set Point	uint32	PSI	25	7 - 99
Argument 3	Fan Air Set Point	uint32	PSI	22	7 - 99
Argument 4	Turbine Speed	uint32	kRPM	25	10 - 60
Argument 5	Electrostatic Voltage Set Point	uint32	kV	85	0, 10 – 100 (1 - 9 not valid)
Argument 6	Electrostatic Current Set Point	uint32	µA	150	0 - 150
Acknowledge	Command Acknowledged	uint32	NONE	2 = ACK	0 - 4
Return 0	Preset Number	uint32	NONE	1	0 - 98
Return 1	Flow / Pressure Set Point	uint32	cc/min or PSI	300	1 - 1600 (cc/min) 1 - 1500 (PSI)
Return 2	Atomizing / Inner Air Set Point	uint32	PSI	25	7 - 99
Return 3	Fan / Outer Air Set Point	uint32	PSI	22	7 - 99
Return 4	Turbine Speed	uint32	kRPM	25	10 - 60
Return 5	Electrostatic Voltage Set Point	uint32	kV	100	0, 10 – 100 (1 - 9 not valid)
Return 6	Electrostatic Current Set Point	uint32	µA	150	0 - 150

## Read Preset

The Read Fluid Control Mode command is used to read the current Fluid Control mode of the system is currently operating under. No arguments are required.

*Example: Read Fluid Control as currently set to Pressure mode.*

DCS Register	Parameter Description	Data Type	Units	Value	Range
DCS Command	Read Preset	uint32	NONE	50	0 - 50
Argument 0	Preset Number	uint32	NONE	1	0 - 98
Acknowledge	Command Acknowledged	uint32	NONE	2 = ACK	0 - 4
Return 0	Fluid Control Mode	uint32	NONE	1	0 - 98
Return 1	Flow / Pressure Set Point	uint32	cc/min or PSI	300	1 - 1600 (cc/min) 1 - 1500 (PSI)
Return 1	Atomizing / Inner Air Set Point	uint32	PSI	25	7 - 99
Return 2	Fan / Outer Air Set Point	uint32	PSI	22	7 - 99
Return 3	Turbine	uint32	kRPM	25	10 - 60
Return 4	Electrostatic Voltage Set Point	uint32	kV	100	0 - 100
Return 5	Electrostatic Current Set Point	uint32	μA	150	0 - 150

## PLC Diagnostic Screens

These screens may be used to verify PLC communications by providing a real-time status of all Network Inputs and Outputs.

### PLC Diagnostic Screens 1–4

These screens show all PD2K Network Outputs with their associated register ID, Modbus TCP address, current value, and any relevant state information.

02/14/17 09:59		PLC Diagnostic		Advanced	
Standby		No Active Errors			
Network Outputs					
ID	Address	Value			
0	40100	11	Standby: Mix Ready		
1	40102	1	Standby		
2	40104	1	Standby		
3	40106	1	Standby		
4	40108	1	Standby		
5	40110	0	-		
6	40112	0	-		
7	40114	4294967295	-		

Figure 8 PLC Diagnostic Screen 1

### PLC Diagnostic Screens 8

This screen encapsulates all the registers used in the Dynamic Command Structure. Arguments and Command registers are shown on the left. Acknowledge and Return registers are shown on the right. When a valid DCS command is sent, the Return registers will display the appropriate data on the right side of the screen. This can be used to test and verify DCS commands with the PLC.

02/14/17 10:00		PLC Diagnostic		Advanced	
Standby		No Active Errors			
DCS					
ID	Address	Value	ID	Address	Value
17	40900	4294967295	30	40800	4294967295
18	40902	4294967295	31	40802	4294967295
19	40904	4294967295	32	40804	4294967295
20	40906	4294967295	33	40806	4294967295
21	40908	4294967295	34	40808	4294967295
22	40910	4294967295	35	40810	4294967295
23	40912	4294967295	36	40812	4294967295
24	40914	4294967295	37	40814	4294967295
			38	40816	4294967295

Figure 10 PLC Diagnostic Screen 8

### PLC Diagnostic Screens 5–7

These screens show all PD2K Network Inputs with their associated register ID, Modbus TCP address, last value written, and any relevant state information.

**NOTE:** If a Network Input has not been written, it will show a value of 4294967295 (0xFFFFFFFF) and state as invalid.

02/14/17 10:00		PLC Diagnostic		Advanced	
Standby		No Active Errors			
Network Inputs					
ID	Address	Value			
0	40400	4294967295	Invalid		
1	40402	4294967295	Invalid		
2	40404	4294967295	Invalid		
3	40406	4294967295	Invalid		
4	40408	4294967295	Invalid		
5	40410	4294967295	Invalid		
6	40412	4294967295	Invalid		
7	40414	4294967295	Invalid		

Figure 9 PLC Diagnostic Screen 5



## Flow Control System

### Overview

Flow control is an optional feature that precisely regulates the flow of material to an automatic spray device, to help ensure adequate coverage and avoid sags or runs in the finish coat. The ProMix PD2K system can control fluid flow by directly controlling the proportioning pumps. The pumps accurately dispense a fixed volume of fluid during each stroke. For this reason, the flow rate of a given pump is directly proportional to the velocity of the pump. As long as the applicator is open and the system is stable, flow control is the most effective method for controlling flow rate.

The flow control system relies on two main inputs for controlling flow rate: Gun Trigger and Control Set Point. **NOTE: These inputs are timing critical. Graco recommends that users wire them discretely to the controller.** Alternatively these two inputs can be driven by the network communications, but latency could be an issue for systems requiring precise timing.

See [System Screen 4, page 102](#) for more details on configuring these options for 'Discrete' or 'Network'.

**NOTE:** Flow control cannot be selected with a manual applicator system.

### Normal Flow Control

The ProMix PD2K will directly control the speed of the pump(s) to the programmed flow control set point to maintain accurate flow rate and ratio. The flow control set point is set by Network Communications or the Discrete Input.

The system is considered to be stable when the pressure readings do not fluctuate and the flow rate is maintained. While the system is considered stable it will store ("learn") the associated pump pressures to a table that is used if the applicator trigger signal is lost or removed.

### Pressure Control

When the applicator trigger signal is removed the system automatically switches to pressure control mode to avoid over pressurizing the fluid lines and to allow smooth transition to flow control if the applicator trigger signal returns. It also works to maintain a consistent flow rate even though it has transitioned to pressure control mode if the applicator trigger signal is inadvertently lost.

### Gun On/Off Prediction

The pressure table also is used to predict if the applicator has been turned on or off (without a change to the applicator trigger input). The flow control system continually monitors the desired outlet pressure compared to the actual outlet pressure. If the actual pressure remains 50% higher than the desired pressure for longer than 10msec, then the system predicts that the applicator trigger has been released. If the actual pressure drops below the desired pressure longer than 10 msec, then the system predicts that the applicator has been triggered.

The applicator on/off prediction is used in the flow control algorithm to prevent the fluid pressure from becoming too high or too low due to a system disturbance. For example, if an applicator off prediction occurs while the applicator trigger input is high, the system will begin to control to the pressure value last stored in the pressure table for the current flow set point.

### System Startup and Defaults

The pressure table is stored in volatile memory, so the table values will be lost after a power cycle of the ProMix PD2K controller. This issue is not significant because the system generally is able to recalculate new pressure table values within a few seconds (depending on the stability of the fluid system).

# Run Mode Screens

**NOTE:** Selection fields and buttons that are grayed-out on the screens are not currently active.

## Opening Screen

At power up, the Graco logo will display for approximately 5 seconds, followed by the Home screen.



Figure 11 Opening Screen

## Home Screen

The Home screen displays the current status of the system. The following table details the information shown.

To view pump flow rates and pressures (as shown), select “Diagnostic Mode” on [System Screen 1, page 96](#).

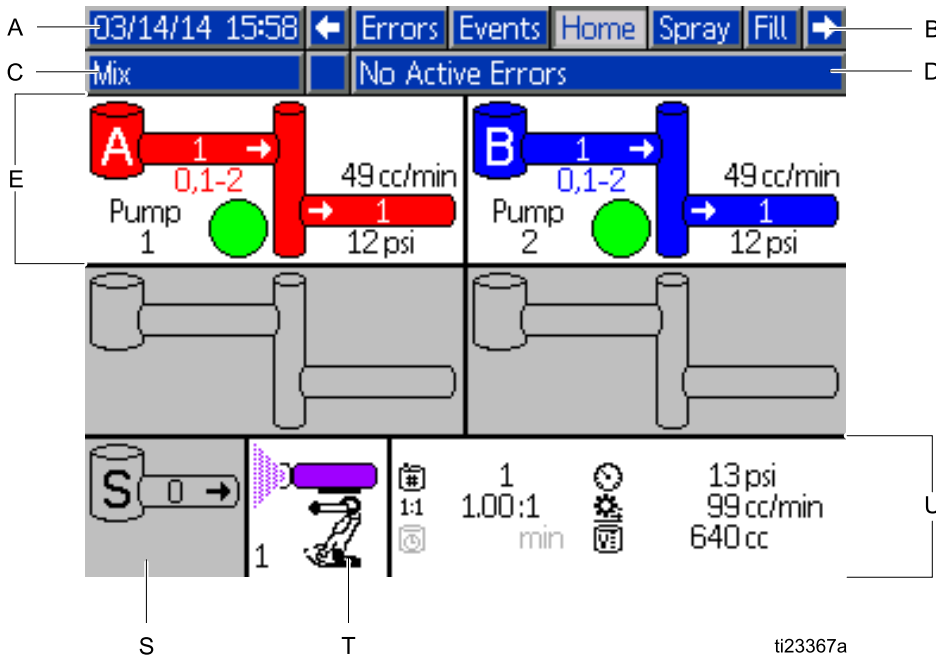

Figure 12 Home Screen, in Mix Mode with Diagnostics On

## Home Screen Key

Key	Description	Details
A	Date and Time	See <a href="#">Advanced Screen 1, page 132</a> , to set.
B	Menu Bar	Run Screens. Use left and right arrow keys to scroll through the different Run screens: <ul style="list-style-type: none"> <li>• Home (shown in Diagnostic Mode)</li> <li>• Spray (see <a href="#">Spray Screen, page 85</a>)</li> <li>• Fill (see <a href="#">Fill Screen, page 93</a>), available only if Manual Override is enabled on <a href="#">System Screen 5, page 102</a>.</li> <li>• Usage (see <a href="#">Usage Screen, page 94</a>)</li> <li>• Jobs (see <a href="#">Jobs Screen, page 95</a>)</li> <li>• Errors (see <a href="#">Errors Screen, page 95</a>)</li> <li>• Events (see <a href="#">Events Screen, page 95</a>)</li> </ul>
C	Status Bar	System Status: Displays the current mode of operation:
		<ul style="list-style-type: none"> <li>• Pump Off</li> <li>• Standby</li> <li>• Startup</li> <li>• Mix</li> <li>• Fill</li> <li>• Purge</li> <li>• Shutdown</li> <li>• Change Recipe</li> <li>• Idle</li> <li>• Prime Pump</li> <li>• Calibrate</li> <li>• Stall Test</li> <li>• Maintenance Test</li> </ul>
D	Error Status	Displays any active error code.
E	Pump Animation and Diagnostic Information	
F	Pump Number (1–4)	
G	Material (A or B)	
H	Available Colors	
J	Pump Inlet Color	
L	Pump Flow Rate	
M	Pump Outlet Color	
N	Pump Outlet Pressure	
P	Pump Indicator Light <ul style="list-style-type: none"> <li>• Clear = power off</li> <li>• Yellow = standby</li> <li>• Green = active</li> </ul>	
S	Solvent Flow Rate	







## Spray Screen

**NOTE:** In normal operating mode, controlled by a PLC, the Spray Screen is display only. No changes can be made. This section provides information about the Spray Screen if Manual Override is enabled on [System Screen 5, page 102](#). The screens show a system in Manual Override mode.

The Spray screen includes the following information:

- Active Recipe (can be changed on this screen)
- Target Ratio
- Actual Ratio
- Target Pressure (if Pressure Mode is selected on System Screen 4) or Target Flow (if Flow Mode is selected). Target pressure or flow can be changed on this screen if system is using dynamic preset '0'; otherwise, target pressure or flow is determined by active preset.
- Actual Pressure
- Actual Flow
- Potlife Remaining
- Applicator Animation

In addition, the Spray screen includes three soft keys:

-  Press to put the system in Standby.
-  Press to spray mixed material.
-  Press to purge the applicator.\*
-  Press to initiate solvent push.

\* When the system is configured for solvent push, the purge soft key will change to the solvent push soft key while in Mix Mode.

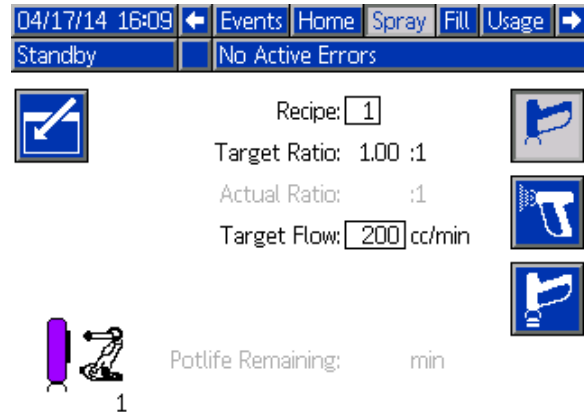

Figure 13 Spray Screen, in Standby Mode

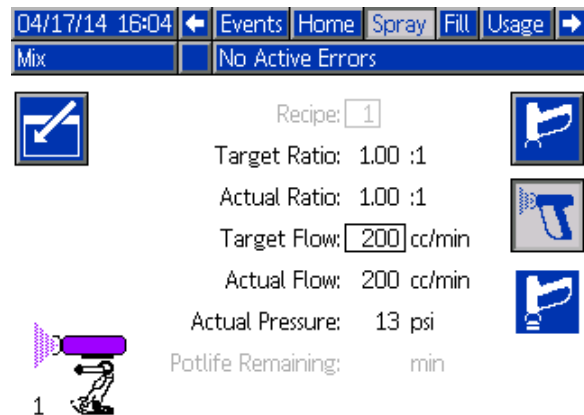

Figure 14 Spray Screen, in Mix Mode

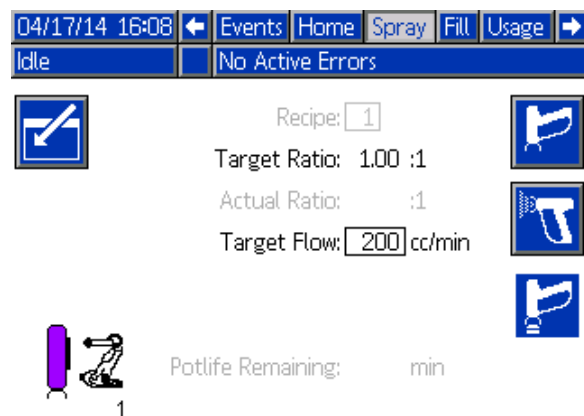

Figure 15 Spray Screen, in Idle Mode

Run Mode Screens

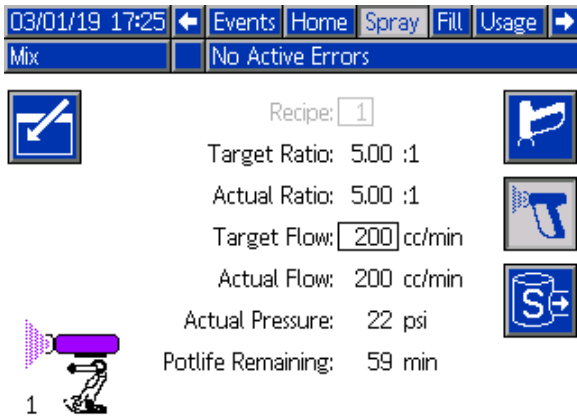



Figure 16 : Spray Screen, in Mix Mode with Solvent Push enabled

## Gun Screen

From any Run Mode screen, use the Left/Right arrow keys to navigate to the Gun screen. Press the Edit

softkey  to enter the screen. The softkey options on the left side of the screen correspond to the

operation modes: Idle , Spray , and Purge 

**NOTE:** In Preset 0, the atomizing air, fan air, voltage, and current are editable from the Gun screen. In Presets 1-98, parameters are set up in advance on the [Preset, page 108](#).

### Gun Off Mode

This screen is displayed when the Gun screen is entered and the applicator is off. Press

the  softkey or enable the system with



the Startup/Shutdown key . See [ADM Keys and Indicators, page 13](#).



### Idle Mode

#### For Conventional and Electrostatic Applicators

When the applicator is turned on it will automatically transition to Idle mode.

Before attempting to spray, select one of the Presets you have set up on the [Preset, page 108](#).

Press  to enable Spray Mode, or  to enable Purge Mode.

- Activate Paint Trigger  – This selection is available only if Local is selected for the Paint Trigger on [Gun Screen 1, page 118](#).
- Activate Atomizing Air 
- Activate Fan Air 

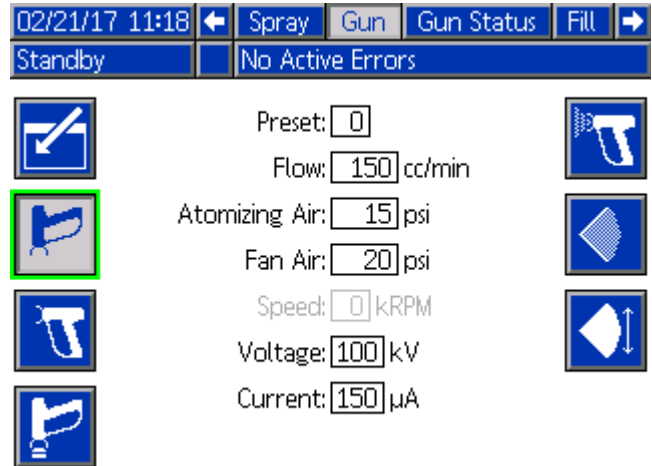

Figure 17 Gun Screen, in Idle Mode

**NOTE:** In Preset 0, the flow, atomizing air, fan air, voltage, and current can be changed from the Spray Gun screen. In Presets 1-98, parameters are set up in advance on the [Preset Screen, page 108](#).

#### For Rotary Atomizers

When the applicator is turned on, the system brings the applicator up to the idle speed set on [Gun Screen 1, page 118](#). The system automatically switches to Idle Mode when idle speed is reached. In Idle Mode, the Inner Shaping Air automatically turns on to help keep the cup and air cap clean. The screen displays the parameters set for the active preset.

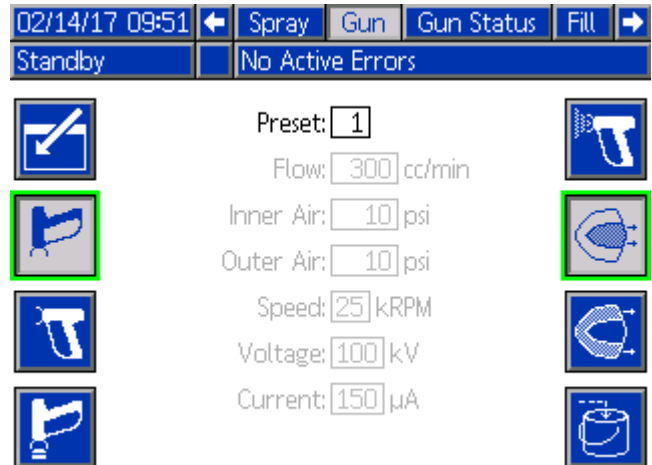







Figure 18 Gun Screen, in Idle Mode

**NOTE:** In Preset 0, the inner shaping air, outer shaping air, speed, voltage, and current can be changed from the Spray Gun screen. In Presets 1-98, parameters are set up in advance on the [Preset Screen, page 108](#).

## Run Mode Screens

In the Preset field, enter one of the Presets you have set up and enabled on the [Preset Screen, page 108](#).

Press  to enable Spray Mode, or  to enable Purge Mode.

- Activate Paint Trigger  – This selection is available only if Local is selected for the Paint Trigger on [Gun Screen 1, page 118](#).
- Activate Inner Shaping Air 
- Activate Outer Shaping Air 
- Activate Dump Valve 

### Spray Mode

#### For Conventional and Electrostatic Applicators

Enter this mode to spray. When Spray Mode is entered, both Atomizing and Fan Airs are

automatically turned on. When Spray Mode  is selected, additional softkeys are available:

- Activate Gun Trigger  – This selection is available only if Local is selected for the Gun Trigger on [Gun Screen 1, page 118](#).

- Activate Atomizing Air 

- Activate Fan Air 

If Electrostatic Control is enabled on [Gun Screen 2, page 120](#):

- Activate Electrostatics  – This selection is available only if Local is selected for the ES Trigger on [Gun Screen 1, page 118](#).

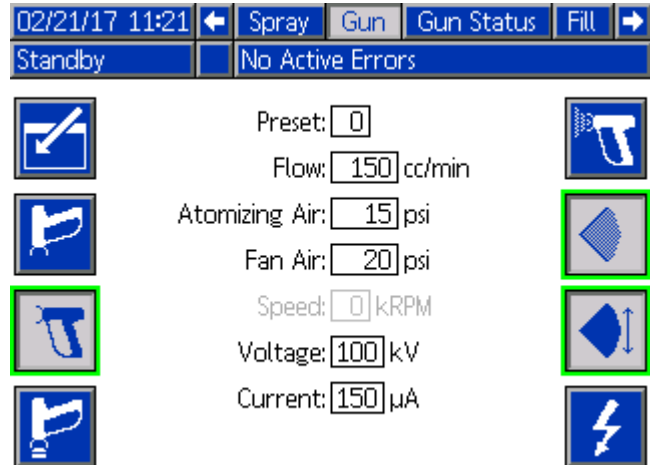

Figure 19 Gun Screen, in Spray Mode



**For Rotary Atomizers**

Enter this mode to spray. When Spray mode is entered, both Inner and Outer Shaping Airs automatically turn on to help keep the bell clean. In spray mode, the bell accelerates to Preset speed.

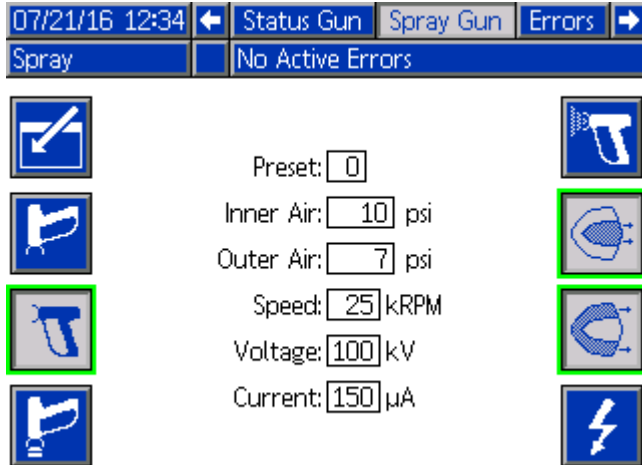



Figure 20 Gun Screen, in Spray Mode

**NOTE:** In Preset 0, the inner shaping air, outer shaping air, speed, voltage and current can be

changed from the Spray Gun screen. In Presets 1-98, parameters are set up in advance on the [Preset Screen, page 108](#).

When Spray  is selected, additional softkey options are available.

If Air Control is enabled on [Gun Screen 2, page 120](#):

- Activate Paint Trigger  – This selection is available only if Local is selected for the Paint Trigger on [Gun Screen 1, page 118](#).

- Activate Inner Shaping Air 

- Activate Outer Shaping Air 

If Electrostatic Control is enabled on [Gun Screen 2, page 120](#) :



- Activate Electrostatics  – This selection is available only if Local is selected for the ES Enable on [Gun Screen 1, page 118](#).

## Purge Mode

### For Conventional and Electrostatic Applicators

Enter this mode to clean the applicator. In Purge Mode, the electrostatics are disabled. Atomizing and

Fan Air can be activated. When Purge Mode  is selected, additional softkeys are available:

- Activate Gun Trigger  – This selection is available only if Local is selected for the Gun Trigger on [Gun Screen 1, page 118](#).
- Activate Atomizing Air 
- Activate Fan Air 

**NOTE:** Operators cannot turn on electrostatics in Purge Mode.

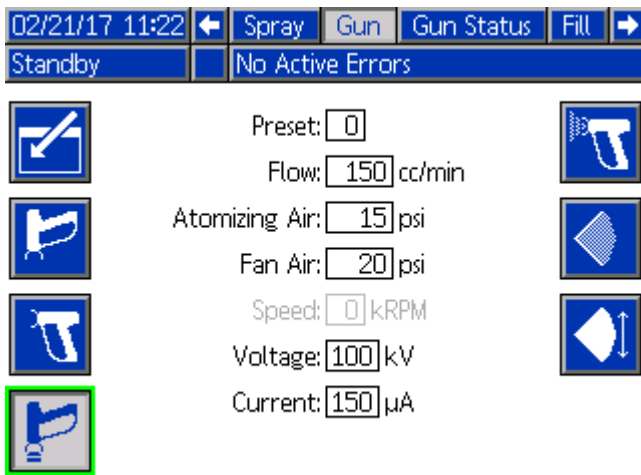

Figure 21 Gun Screen, in Purge Mode

### For Rotary Atomizers

Enter this mode for color change or to clean the applicator. In Purge mode, the electrostatics are disabled. Inner shaping air is active. Operators cannot turn on electrostatics in Purge mode. Purge mode uses the spray parameters of the active preset.

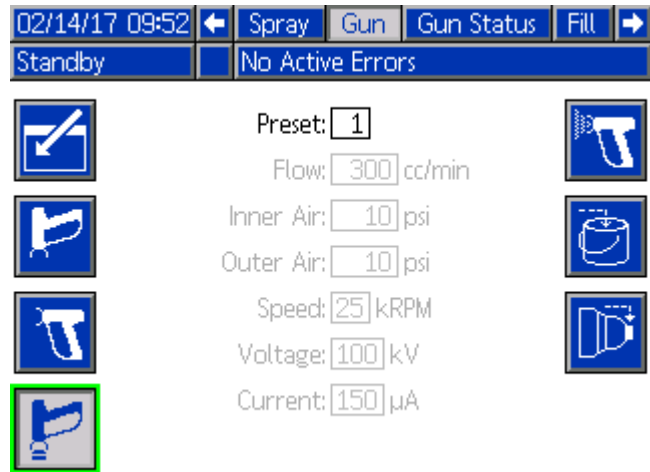



Figure 22 Gun Screen, in Purge Mode



**NOTE:** In Preset 0, the inner shaping air, outer shaping air, speed, voltage and current can be changed from the Spray Gun screen. In Presets 1-98, parameters are set up in advance on the [Preset Screen, page 108](#).

When Purge  is selected, additional softkey options are available.

If Air Control is enabled on [Gun Screen 2, page 120](#):

- Activate Paint Trigger  – This selection is available only if Local is selected for the Paint Trigger on [Gun Screen 1, page 118](#).

**NOTE:** The Paint Trigger softkey is inactive until the electrostatics discharged timer has expired.

- Activate Dump Valve 
- Activate Cup Wash Valve 

**NOTE:** The Cup Wash Valve softkey is inactive until the electrostatics discharged timer has expired.

## Gun Status Screen

The Gun Status screen displays the current status of the applicator. The following table details the information shown.





02/14/17 10:10					
Gun Gun Status Fill Potlife					
Standby		No Active Errors			
0	◇	◇I	⌚	kV	μA
Target	25 psi	15 psi	--	--	--
Actual	25 psi	15 psi	--	--	--
Gun State	Idle		Atomizing	●	
			Fan Air	●	
			Paint 1	○	
			Paint 2	○	
			Paint 3	○	
			Solenoid 3	○	

Gun Status Screen, Electrostatic Applicator in Idle Gun State

02/14/17 10:02					
Gun Gun Status Fill Usage					
Standby		No Active Errors			
0	◇	◇	⌚	kV	μA
Target	25 psi	30 psi	15 kRPM	100	150
Actual	25 psi	30 psi	15 kRPM	0	0
Gun State	Idle		Inner Air	●	
			Outer Air	○	
			Paint	○	
			Dump	○	
			Cup Wash	○	
			Solenoid 3	○	

Gun Status Screen, Rotary Atomizer in Idle Gun State

### Gun Status Screen Key

Key	Description	Details
	Preset (Preset Number)	Displays the current active preset.
	Atomizing Air / Inner Shaping Air	Displays the target and the actual pressure for the atomizing/inner shaping air in selected pressure units. See <a href="#">Advanced Screen 2, page 133</a> to set pressure units. Dashes (- -) indicate that this feature is not available. A green circle indicates that the atomizing/inner shaping air is on.
	Fan Air / Outer Shaping Air	Displays the target and the actual pressure for the fan/outer shaping air in selected pressure units. See <a href="#">Advanced Screen 2, page 133</a> to set pressure units. Dashes (- -) indicate that this feature is not available. A green circle indicates that the fan/outer shaping air is on.
	Rotational Speed	Displays the target and actual rotational speed in thousands of rotations per minute (kRPM). Displays pressure if Speed Control Type is set to Bypass on <a href="#">Gun Screen 4, page 122</a> .
kV	Electrostatic Voltage	Displays the electrostatic spraying voltage set point and the actual spraying voltage in kilovolts (kV).
μA	Electrostatic Current	Displays the electrostatic spraying current set point and actual spraying current in microamps (μA).
	Applicator Image	Displays an image of the current applicator type.

Run Mode Screens

Key	Description	Details
	Gun State	<p>Displays the current mode of operation:</p> <ul style="list-style-type: none"> <li>• Gun Off</li> <li>• Idle</li> <li>• Spray</li> <li>• Purge</li> <li>• Calibration</li> <li>• Maintenance</li> </ul>
	Solenoid Status	<p>Display the current status of each solenoid. Green circle means solenoid is active. The solenoids include:</p> <ul style="list-style-type: none"> <li>• Atomizing Air / Inner Air</li> <li>• Fan Air / Outer Air</li> <li>• Paint Trigger</li> <li>• Auxiliary 1 / Paint Trigger 2* / Dump**</li> <li>• Auxiliary 2 / Paint Trigger 3* / Cup Wash**</li> <li>• Auxiliary 3</li> </ul> <p><b>NOTE:</b> Auxiliary 1, 2, and 3 can only be turned on by PLC variables.</p> <p>* – Multiple applicator triggers are only supported with Gun Type: AirPro Auto, G40 Auto, and AirPro EFX.</p> <p>** – Available only when Gun Type is equal to ProBell.</p>





## Fill Screen

**NOTE:** This screen is visible only if Manual Override is enabled on [System Screen 5, page 102](#).

The Fill screen displays the following information for the pump assigned to the current color:

- Material. Select Color (A), Catalyst (B), or Solvent. The pump animation at the top of the screen will show the selected material.
- Flush Line (only for systems with color change). Select this box if you want to flush the specified material line. The system uses flush sequence 1.

To prime the pumps and fill the lines, first read [Prime and Fill the System, page 26](#).

1. Press the Edit softkey  to open the screen for editing.
2. Select Color (A).
3. If the selected material is not already loaded, press the Prime softkey . The system will prime Color (A) into the selected pump through the selected color valve and out the outlet dump valve.
4. Press the Fill softkey . The system will attempt to fill the Color (A) lines until the user presses Stop . Trigger the applicator into a waste container.
5. Repeat for Catalyst (B).

### Pump Pre-Fill Option

The pump pre-fill option is available for pumps that have color change, but only a single material (color or catalyst). The pre-fill option may be used for pumps that remained filled with material while the system was powered down. Pressing the Pre-Fill

softkey  will “prime” the pump without flushing or expelling any material unnecessarily.

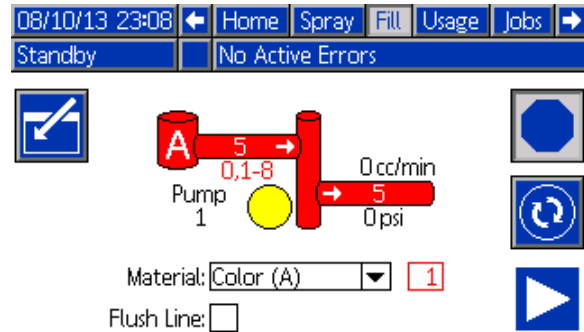

Figure 23 Fill Screen, Color (A) Selected

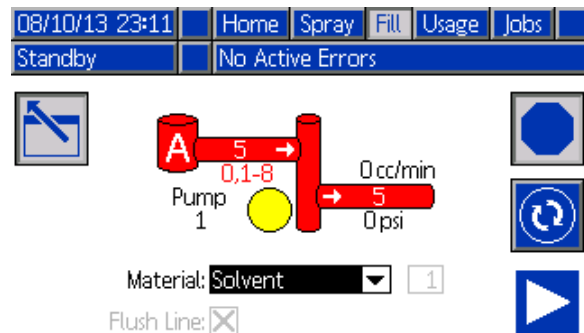

Figure 24 Fill Screen, Solvent Selected

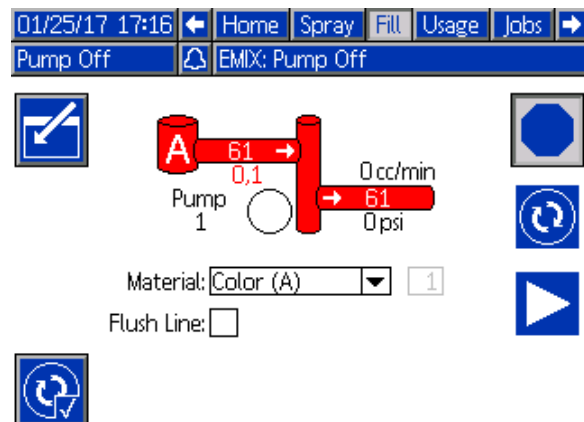

Figure 25 Fill Screen, with Pump Pre-Fill Option

## Potlife Screen



With Multiple Guns enabled, an additional Run Mode screen is now accessible. This screen will show all recipes that are currently loaded in an applicator that have a non-zero potlife, and the amount of time remaining in the potlife.

Recipe	Potlife	Material	Volume
1	51 min	11	21
2	119 min	12	22
3		13	23
4		14	24
5		15	25
6		16	26
7		17	27
8		18	28
9		19	29
10		20	30

Figure 26 Potlife Screen

## Usage Screen

The first Usage screen displays the current job usage and grand total usage of component A, B, A+B, and solvent (S). Edits may be made only if Manual Override is enabled on [System Screen 5, page 102](#). The second Usage screen displays the total volume pumped for all available materials.

1. Press the Edit softkey  to open the screen for editing.
2. To enter or change the User ID (⌘), select the field to open the User ID Keyboard screen, and enter the desired name (10 characters maximum).
3. To log the current job, press the Job Complete softkey . This will clear the current usage fields and increment to the next job number. The Grand Totals cannot be cleared. See the [Jobs Screen, page 95](#), to review past jobs.

4. Press the Edit softkey  to close the screen.

Material	Usage	Grand Total
A	13259 cc	4 gal
B	13257 cc	4 gal
A+B	26516 cc	7 gal
S	0 cc	0 gal

Figure 27 Usage Screen

User ID

John Doe12

Figure 28 User ID Keyboard Screen

Pump	Type	Material	Volume
1	Color (A)	1	51790 cc
1	Color (A)	2	0 cc
1	Color (A)	3	0 cc
1	Color (A)	4	0 cc
1	Color (A)	5	5942 cc
1	Color (A)	6	0 cc
1	Color (A)	7	0 cc
1	Color (A)	8	0 cc
2	Catalyst (B)	1	578942 cc
3	Color (A)	17	3203 cc

Figure 29 Usage Log



# Setup Mode Screens

Press  on any Run screen to enter the Setup screens.

**NOTE:** Selection fields and buttons that are grayed-out on the screens are not currently active.

If the system has a password lock, the Password screen displays. See [Password Screen, page 96](#).

## Password Screen

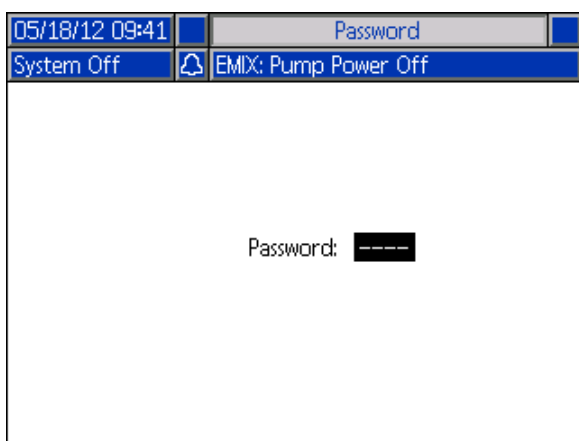



Figure 33 Password Screen

Enter the 4 digit password, then press . System screen 1 will open, allowing access to the other Setup screens.

Entering an incorrect password clears the field. Reenter the correct password.

To assign a password, see [Advanced Screen 1, page 132](#).

## System Screen 1

System screen 1 includes the following fields which define your system.

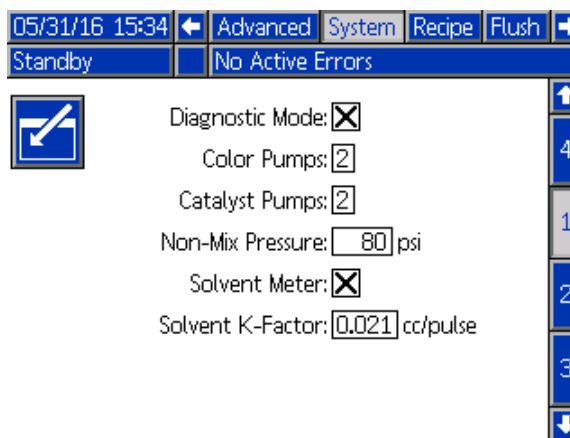

Figure 34 System Screen 1, During Standby

### Diagnostic Mode

Select this box to display flow rate and pressure for each pump on the [Home Screen, page 82](#).

### Color Pumps

Enter the number of color pumps in your system.

### Catalyst Pumps

Enter the number of catalyst pumps in your system.

### Non-Mix Pressure

Enter a lower pressure for use when not mixing and spraying (for example during fill or flushing).

**NOTE:** Low pressure systems may be set 100 psi (0.7 MPa, 7 bar) lower than target pressure; high pressure systems may be set 300 psi (2.1 MPa, 21 bar) lower than target pressure.

### Solvent Meter

Select this box if your system uses a solvent meter. The Solvent K-Factor field will then become active.

### Solvent K-Factor

Enter the solvent meter K-Factor.



## System Screen 2

System screen 2 sets the following system operating parameters.

Figure 35 System Screen 2, in Standby Mode

Figure 36 System Screen 2, with Solvent Push Enabled

### Mix Idle Timeout

The Gun Trigger Input signals that the device is triggered. If you are not using an applicator trigger signal, the system does not know if the applicator is spraying. If a pump failed you could spray pure resin or catalyst without knowing. This should be caught by the Mix No Flow Timeout; the default is 5 seconds. The Mix Idle Timeout will trigger Idle mode, which will run a pump stall test to check for leaks, then put the pumps in Standby (holding their current position) after the designated period of time. Enter the desired Mix Idle Timeout in this field.

See [Digital Inputs, page 29](#).

### Mix No Flow Timeout

The Gun Trigger Input signals that the applicator is triggered. If the Gun Trigger Input indicates that the applicator is triggered, but there is no fluid flow through a pump, you could spray pure resin or catalyst without knowing. The Mix No Flow Timeout will cause the system to shutdown after the designated period of time. The default is 5 seconds. Enter the desired shutdown time in this field.

See [Digital Inputs, page 29](#).

### Auto Park Pumps

Parking the pumps will help prevent material from hardening on the pump rods. The Auto Park Pumps timer (in minutes) will automatically park all pumps and turn off pump power. The default value of 0 minutes turns off this feature.

**NOTE:** The timer only runs while the system is in Standby, and all applicators are purged, to prevent volumes from going off-ratio.

### Mix Balance Interval

Use the Mix Balance Interval set point to enable a transition time between Standby Mode and Mix Mode. This transition time allows the fluid to balance to avoid engaging nuisance alarms.

**NOTE:** The Mix Balance Interval timer only runs while the gun is triggered. Setting this time to zero turns the timer off

### Solvent Push Enable

Switching from resin to solvent before concluding a mix or spray cycle may benefit some fluid stream configurations.

Select this box to enable Solvent Push.

#### Note



This feature only displays if the ADM is configured for Solvent Push. See [Solvent Push Configuration, page 99](#).

## Mix Volume Percent

The displayed volume shows the total amount of solvent that will dispense during the solvent push sequence. The system dispenses a percent of the mix hose volume to prevent solvent atomization.

The default value is 0%, which will not dispense solvent.

Set the Gun Hose Length and Gun Hose Diameter to configure this value. See [System Screen 4, page 102](#).

				
If using an electrostatic gun, to reduce the risk of fire and explosion, confirm that the mix hose parameters are accurately represented in the settings.				

### Solvent Push Details

- [Solvent Push Configuration, page 99](#)
- [Solvent Push Operation, page 100](#)

## Max Flow Rate

The system uses the scaling factor to translate the 4 to 20 mA input from a discrete connection. Enter the flow rate or pressure (depending on system operating mode) that should correspond to a 20 mA input. The system automatically assigns a flow rate or pressure of 0 to an input of 4 mA.

Use the Max Flow Rate setting to limit the total flow rate while in Mix mode. Variables, such as ambient conditions or applicator tip adjustments, can affect flow rates. Controlling the max flow rate can result in a more consistent application and reduce material loss.

The default setting is 0. When set to 0, the system does not limit the flow rate beyond what the pumps are capable of delivering.

**NOTE:** The Max Flow Rate is a global set point that will apply to all recipes the same.

## Solvent Push Configuration

Configure the system for Solvent Push. See [Multiple Color-In, Single Color-Out \(MISO\) configuration, for Solvent Push](#).

Set the following ADM settings in the following order to enable the solvent push feature.

1. Set the Fluid Control to **Flow Mode** on **System Screen 5**. See [System Screen 5, page 102](#).
2. Set the following settings on **Pump Screen 4**. See [Pump Screen 4: Advanced Configuration, page 112](#):
  - Set the **Outlet Color Change** to Single.
  - Set the **Remote Color Change** to Disabled. This configuration typically does not use a remote color change stack.
3. Select **Enable Solvent Push** on **Screen 2**. See [System Screen 2, page 97](#).

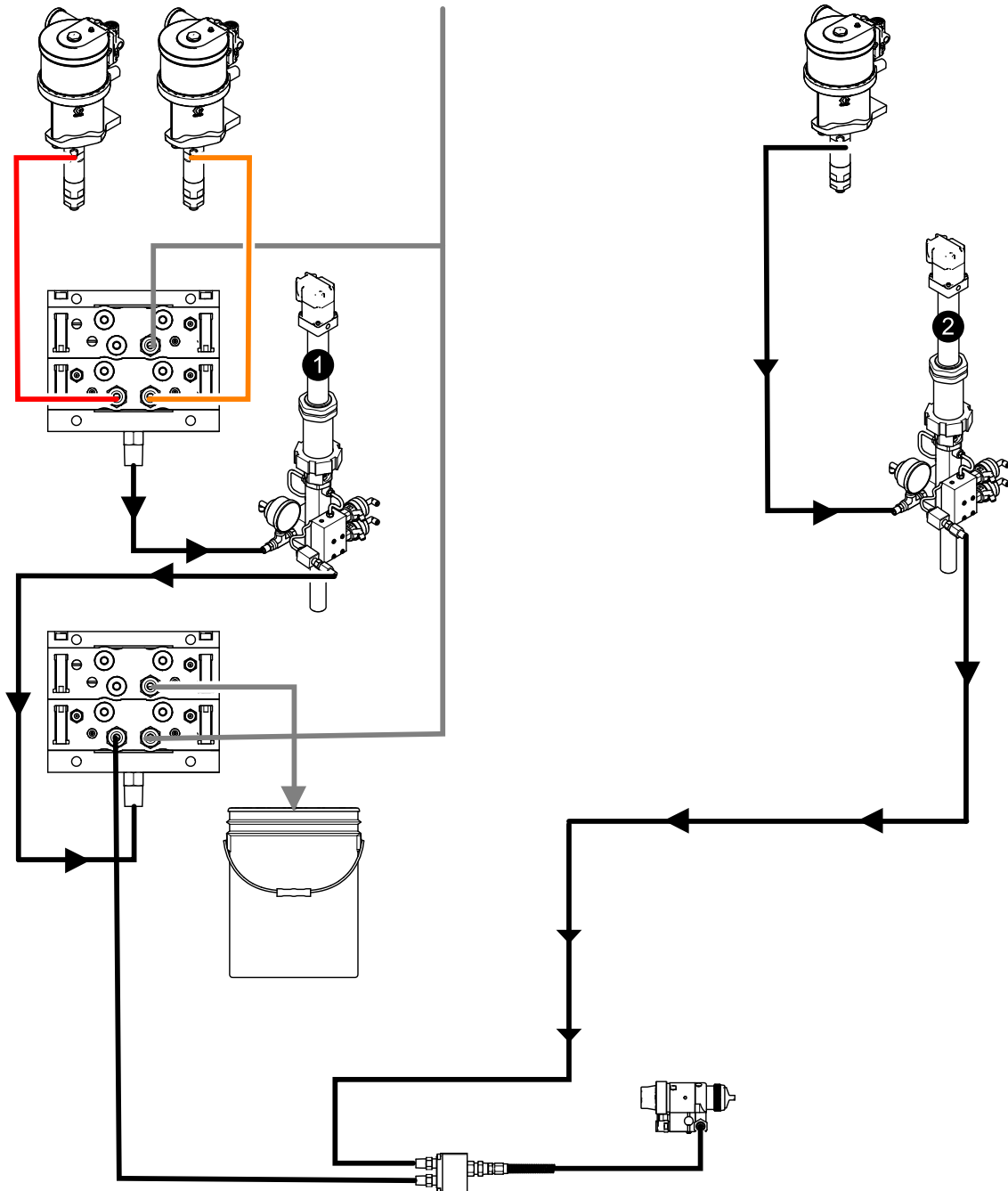



Figure 37 Multiple Color-In, Single Color-Out (MISO) configuration, for Solvent Push

## Solvent Push Operation

The solvent push sequence switches from resin to solvent before concluding a mix or spray cycle.

1. Configure system for Solvent Push operation. See [Solvent Push Configuration, page 99](#).
2. Initiate a Solvent Push sequence before a spray or mix cycle concludes.
  - **ADM Operation:** Press the Solvent Push soft



key  on the ADM Spray Screen. See [Spray Screen, page 85](#).

- **PLC Operation:** Initiate Solvent Push on the PLC. See [ProMix PD2K Network Inputs, page 46](#).

### Note

Carefully time the Solvent Push sequence to end before the spray or mix cycle concludes. If the spray or mix cycle ends before the solvent push ends, the system will go into standby and must complete a recipe change before mixing again.

### System Screen 3

System screen 3 sets the following system operating parameters.

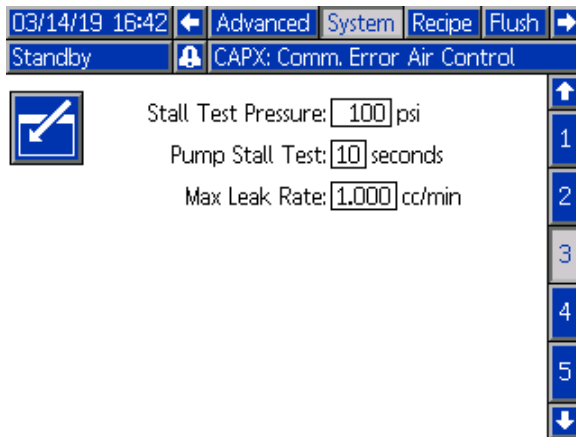

Figure 38 System Screen 3, in Standby Mode

### Maximum Leak Rate

Enter the maximum allowable leak rate for a pump stall test.

### Stall Test Pressure

Set the minimum stall test pressure. The setting should be approximately 50 psi (0.35 MPa, 3.5 bar) higher than the highest inlet pressure.

NOTE: If the material supply pressure at the pump inlet is greater than 90% of the Stall Test Pressure, the system will generate an alarm and will not complete the stall test. See [Calibrate Screen 1, page 126](#).

### Pump Stall Test

Set the duration for the pump stall test. See [Calibrate Screen 1, page 126](#).

## System Screen 4

System Screen 3 sets the following system operating parameters.

03/01/19 17:12 | Advanced | System | Gateway

Pump Off | EMIX: Pump Off

Multiple Guns:

Gun Hose Length:  ft

Gun Hose Diameter:  in

Mix At Wall:

---

Hose Length A:  ft

Hose Diameter A:  in

Hose Length B:  ft

Hose Diameter B:  in

Figure 39 System Screen 4

### Multiple Guns

Check this box to enable the option to use more than a single applicator (with a maximum of three). See [Appendix B: Multiple Guns, page 171](#).

NOTE: Multiple Guns field is disabled if Gun Type on [Gun Screen 1, page 118](#), is equal to Pro Xpc Auto or ProBell.

### Gun Hose Length

Enter the length of the hose from the remote mix manifold to the applicator.

### Gun Hose Diameter

Enter the diameter of the hose from the remote mix manifold to the applicator. The minimum diameter is 1/8 in. (3 mm).

### Mix At Wall

This field should always be enabled unless not using a remote mix module.

### Hose Length and Diameter

Enter the length and diameter of the hose from the remote color stack to the remote mix manifold, for both A and B hoses.

## System Screen 5

System screen 4 sets the following system operating parameters.

03/01/19 17:14 | Advanced | System | Gateway

Pump Off | EMIX: Pump Off

Fluid Control:

Manual Override:

Gun Trigger:

Flow Control:

Max Set Point:

Low Flow Tolerance:  %

Low Flow Timeout:  seconds

Figure 40 System Screen 5

### Fluid Control

Select the desired operating mode (pressure or flow), using the drop-down menu.

- In **Pressure Mode**, the motor will adjust the pump speed to maintain the fluid pressure set by an external control device.
- In **Flow Mode**, the motor will maintain a constant speed to maintain the target flow rate set by an external control device.

### Manual Override

Check this box to give users system control at the ADM. Leave the box unchecked if all system settings are controlled through a PC, PLC, or other networked device.

### Mix Fill Set Point

Set a higher flow rate or pressure for use while mix filling to decrease the time needed to fill the hose and applicator. Once the applicator is filled, the system will use the target set point as set by the PLC.

The default value is '0'. When set to '0', the system ignores the Mix Fill Set Point and instead uses the target set point as set by the PLC.

The value will be a flow rate if Fluid Control is set to 'Flow', or a pressure if Fluid control is set to 'Pressure'.

## Gun Trigger Signal

This field cannot be modified by the user. The Gun Trigger Signal is controlled by user configuration of Gun Trigger parameter on [Gun Screen 1, page 118](#).

- Discrete — the signal is sent via a direct, hard-wired connection. (When Gun Trigger is configured as 'Discrete'.)
- Network — the signal is sent via a PC, PLC, or other networked device. (When Gun Trigger is configured as 'Network' or 'Local'.)

## Flow Control (Set Point Signal)

Select the format of the signal that indicates system flow rate or pressure.

- Discrete — the signal is sent via a direct, hard-wired connection. This selection will make the Max Rate field active.

- Network — the signal is sent via a PC, PLC, or other networked device.

## Low Flow Tolerance

This field is active if Fluid Control is set to 'Flow'. The system will detect if the flow rate falls below a designated percentage of the target flow rate. Set that percentage in this field. For example, you might want the system to time out if it detects a flow rate that is 10 percent of the target, rather than waiting until a no flow timeout occurs.

## Low Flow Timeout

The low flow timeout causes the system to shut down after the designated period of time if the flow rate continues to be at or below the low flow tolerance set in the previous section. The default is 5 seconds. Enter the desired shutdown time in this field.

## Recipe Screen

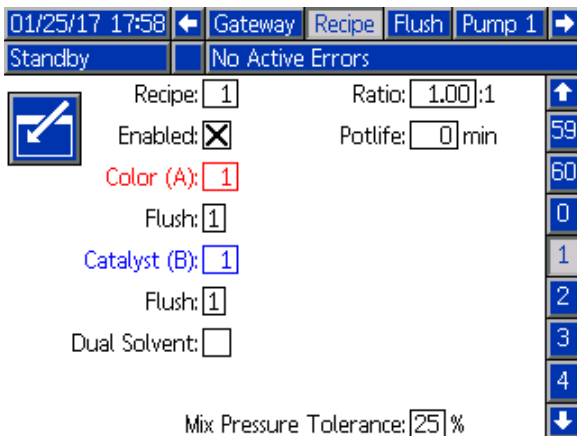

Figure 41 Valid Recipe Screen

### Recipe

Enter the desired recipe number (1-60).

### Recipe 0

Use Recipe 0 to flush the system.

- **If a recipe (1–60) is loaded:** Select Recipe 0 to flush the previously active pumps and purge the applicator.
- **If Recipe 0 or 61 is loaded:** Select Recipe 0 to flush all pumps and purge the applicator.

### Enabled

Selecting “Enabled” makes the selected recipe accessible from the Spray screen on the ADM or to the PLC.

**Note:** Recipe 0 is always enabled.

### Color (A) Valve

Enter the desired color valve number (1-30).

**NOTE:** If you enter a number which is not valid in your system configuration, the field will be highlighted and the recipe becomes invalid. For example, if your configuration has 8 color valves and you enter 30, the field will appear as shown below.

### Catalyst (B) Valve

Enter the desired catalyst valve number (1-4).

**NOTE:** If you enter a number which is not valid in your system configuration, the field will be highlighted and the recipe is invalid. For example, if your configuration has 1 catalyst valve and you enter 4, the field will be highlighted and the recipe is invalid.

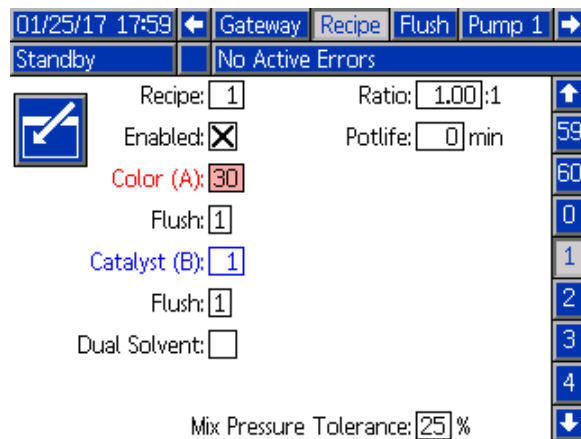

Figure 42 Invalid Recipe Screen

### Flush Sequence

Enter the desired flush sequence (1-5) for the color (A) valve and the catalyst (B) valve. The applicator purge time for each material depends on the flush sequence assigned to each. See [Flush Screen, page 106](#). If materials A and B require different purge times, assign separate flush sequences. Set the necessary applicator purge time for each. For hard to flush colors, select a longer sequence. 1 is the default, and should be designated for the longest, most thorough flush duration.

### Mix Ratio

Enter the desired mix ratio (0 to 50.0):1.

### Potlife Time

Enter the potlife time (0 to 999 minutes). Entering 0 disables this function.

### Mix Pressure Tolerance

The pressure of one component must be within a percentage ( $\pm$ ) of the pressure of the other component during spray or mix. Set the desired Mix Pressure Tolerance in this field. The default is 25%. See [Recipe Screen, page 104](#).



### Dual Solvent

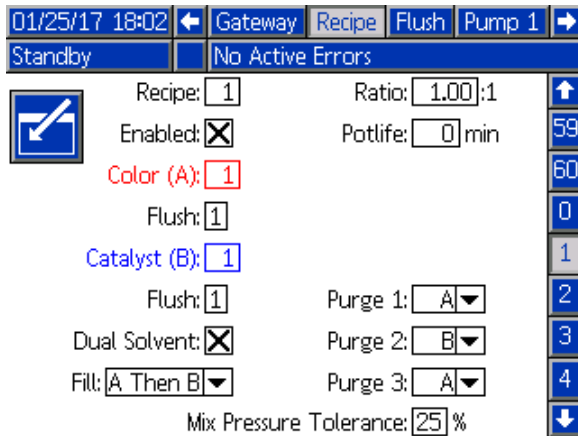

Figure 43 Dual Solvent Recipe Screen

Selecting 'Dual Solvent' enables the sequencing of flushing mixed material for a system using two types of solvent (i.e., water and solvent based) that should not be mixed together.

### Purge 1, 2, and 3

Select the sequence for purging the mixed material from the mix hose and applicator. Each stage of the sequence can be set to either 'A' or 'B'. The solvent corresponding to each material will be dispensed out the applicator for the Gun Purge Time of the Flush sequence assigned to that material for each stage. See Table 6 for a progression of the successive stages of the purge sequence.

### Fill

Select the sequence for dispensing material into the mix hose and applicator. The choices are: 'A then B', 'B then A', and 'Parallel', if no fill sequencing is necessary. The fill sequence is typically dictated by the last material used in the purge sequence. See Table 6 for a progression of the fill sequence following the last stage of the purge sequence.

Table 7 The Progression of Purge Sequence and Fill Sequence in a Dual Solvent System

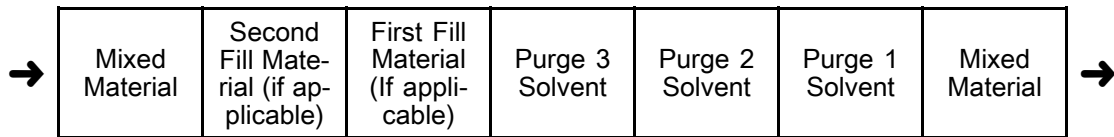

## Flush Screen

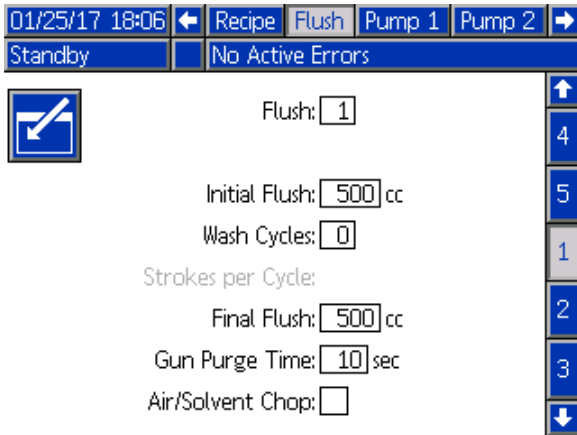

Figure 44 Flush Screen

### Flush Number

Enter the desired flush sequence (1-5). For hard to flush colors, select a longer sequence. 1 is the default, and should be designated for the longest, most thorough flush duration.

### Initial Flush

Enter the initial flush volume (0 to 9999 cc).

### Wash Cycles

A Wash Cycle activates the pump with the valves closed, to use pumping motion to thoroughly clean the pump. Enter the desired number of wash cycles (0 to 99). Entering a number will make the Strokes per Cycle field active.

### Strokes per Cycle

Enter the desired pump strokes per wash cycle (0 to 99). Default is 1.

### Final Flush

Enter the final flush volume (0 to 9999 cc).

### Gun Purge Time

Enter the applicator purge time (0 to 999 seconds).



## Preset Screen

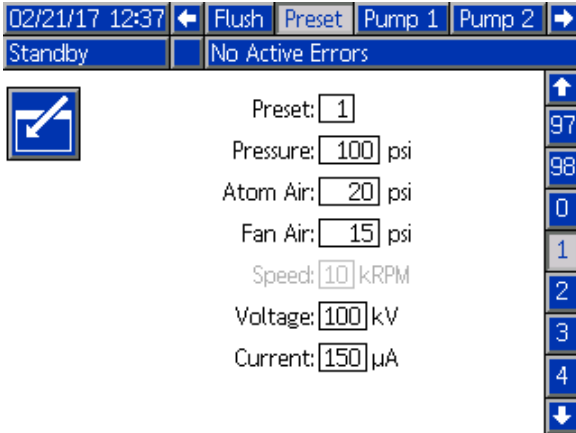

Figure 46 Preset Screen, Conventional and Electrostatic

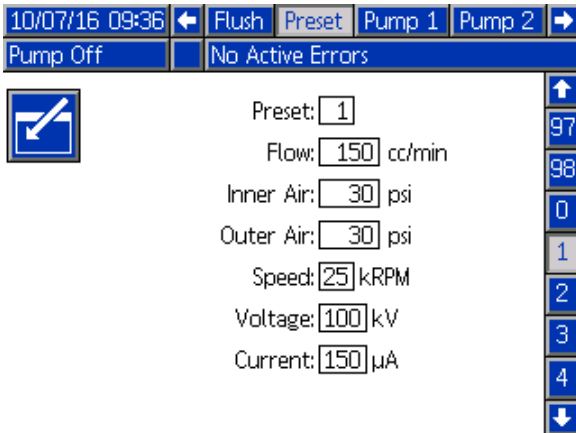

Figure 47 Preset Screen, Rotary Atomizer

### Preset

Enter the desired preset. Any modifications to fixed presets (1–98) will update values while running. Any updates to the dynamic preset (0) will only update values at power up.

## Flow / Pressure

Whether this field is Flow or Pressure is determined by the Fluid control setting on [System Screen 5, page 102](#). *If Flow*, enter the flow rate 0-1600 (cc/min). *If Pressure*, enter the pressure 0-1500 (psi, bar, MPa).

### Atomizing Air / Inner Air

This field is available only if Air Control is enabled on [Gun Screen 2, page 120](#). Use the number keypad to set the desired pressure for the atomizing/inner air. Enter the atomizing air pressure (7-99 psi, 0.5-6.8 bar, 0.05-0.68 MPa).

### Fan Air / Outer Air

This field is available only if Air Control is enabled on [Gun Screen 2, page 120](#). Use the number keypad to set the desired pressure for the fan/outer air. Enter the atomizing air pressure (7-99 psi, 0.5-6.8 bar, 0.05-0.68 MPa).

### Speed

This field is available only if Speed Control is enabled on [Gun Screen 3, page 121](#). Use the number keypad to set the desired turbine rotation speed in Speed Control mode or desired turbine pressure in Bypass mode. Range=10-60 kRPM; Default=25 kRPM.

### Voltage

This field is only available if Electrostatic Control is enabled on [Gun Screen 4, page 122](#). Use the number keypad to set the desired spraying voltage, in kilovolts (kV). Range=0-100 kV; Default=100 kV.

### Current

This field is only available if Electrostatic Control is enabled on [Gun Screen 4, page 122](#). Use the number keypad to set the desired spraying current, in micro-amperes (µA). Range=0-150 µA; Default=150 µA.

## Pump Screen 1: Pump Definitions

**NOTE:** Your system may include 2, 3, or 4 pumps. Information for each pump is accessible under a separate tab in the menu bar at the top of the screen. Select the tab for the desired pump. Each pump has three screens. The same fields appear on all pump tabs.

**Pump screen 1 includes the following fields which define the pump.**

The screenshot shows the Pump 1 (Resin) screen. At the top, there is a menu bar with 'Flush', 'Pump 1', and 'Pump 2' tabs. Below the menu bar, the status is 'Standby' and 'No Active Errors'. The main configuration area includes:
 

- Pump Size: 70cc (dropdown menu)
- Inlet Pressure: Disabled (dropdown menu)
- Color Change:
- Materials: 01 (text input)
- Total Hose Length: 0 ft (text input)
- Pump Hose Diameter: 0.000 in (text input)
- Remote Valve Map: (text input)
- Valve Mapping: Standard (dropdown menu)
- Available Colors: 1 - 1 (text)

 On the right side, there is a vertical navigation bar with buttons for '3', '1', and '2', and up/down arrows.

Figure 48 Pump 1 (Resin) Screen

**Pump screen 2 includes the following fields which define the pump.**

The screenshot shows the Pump 2 (Catalyst) screen. At the top, there is a menu bar with 'Pump 1', 'Pump 2', and 'Calibrate' tabs. Below the menu bar, the status is 'Standby' and 'No Active Errors'. The main configuration area includes:
 

- Pump Size: 35cc (dropdown menu)
- Inlet Pressure: Disabled (dropdown menu)
- Color Change:
- Materials: 01 (text input)
- Total Hose Length: 0 ft (text input)
- Pump Hose Diameter: 0.000 in (text input)
- Catalyst Valve Map: (text input)
- Valve Mapping: Standard (dropdown menu)
- Available Catalysts: 1 - 1 (text)

 On the right side, there is a vertical navigation bar with buttons for '3', '1', and '2', and up/down arrows.

Figure 49 Pump 2 (Catalyst) Screen

### Pump Size

Select 35cc or 70cc, as appropriate.

### Inlet Pressure

Select one of the following:

- Disabled
- Monitor, to track inlet pressure (requires inlet pressure transducer)

### Select Color Change

Select this box if your system uses color change.

### Materials

Enter the number of materials used in your system. Each color change module controls 8 colors.

### Hose Length

Compute the length of the hoses from the supply stack to the pump and from the pump to the outlet stack. Enter the total length.

### Hose Diameter

Enter the diameter of the supply and output hoses.

## Color Change Valve Mapping

### Valve Mapping

Select whether to use Standard, static valve mapping, or fully configurable Custom valve mapping. The color change valve mapping is the assignment of the location of the solenoids in the color change control modules. A static, pre-determined map layout makes for an easily predictable and hands-free option. However, an application and user may benefit from laying out the valve mapping on their own for consolidation of equipment, reduced hardware complexity, or simply to lay out valves according to what makes most sense.

See [Custom Valve Mapping, page 110](#), for more detailed information.

### Remote Valve Map

Select an alternate static valve map for the IS color change modules. This is useful for a system that has more than one color pump but relatively few color change materials. The alternate maps allow for consolidating 2 color pumps (Alternate 1) or 3 color pumps (Alternate 2) onto a single IS color change module. See the Color Change and Remote Mix Manifold Kits manual (333282) for valve maps.

**NOTE:** This selection is only available on Pump Screen 1 for color pumps.

### Catalyst Valve Map

Select an alternate static valve map for a system with two catalyst pumps that requires one pump to change among three catalysts and only a single catalyst on the other pump. See the Color Change and Remote Mix Manifold manual (333282) for more valve maps.

**NOTE:** This selection is only available on Pump Screen 1 for catalyst pumps with color change enabled.

## Custom Valve Mapping

For a PD2K system that has color change, the user has an option for how the control solenoids are mapped on the control modules. Selecting Standard (default) will use the traditional, static valve mapping. The static maps are laid out logically and established for retro-fitting. If Standard is selected no additional set up for the color change valves is required at the ADM. For more information or to see the static map layouts, refer to manuals 332455 and 333282.

By selecting Custom, every color change solenoid may be assigned to any unique, valid control module location. This option offers the ultimate customization as well as the benefit of consolidation of equipment. Additionally, custom valve mapping enables some advanced color change valve features.

**NOTE:** This option applies to all pumps, so changing it for one will change it for all.

**NOTE:** When going from Standard to Custom, the PD2K will automatically pull in the static map assignments for all valves as a starting point. When going from Custom to Standard, the PD2K will clear all custom valve assignments and revert to the static mappings.

## Available Colors

The module displays the number of colors available in your system. This field is not editable.

## Pump Screen 2: Transducer Settings

Pump screen 2 sets the pressure transducer settings for the pump.

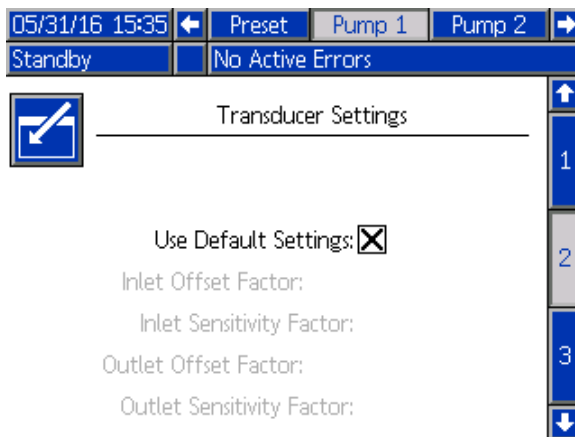

Figure 50 Pump Screen 2, Default Settings Enabled

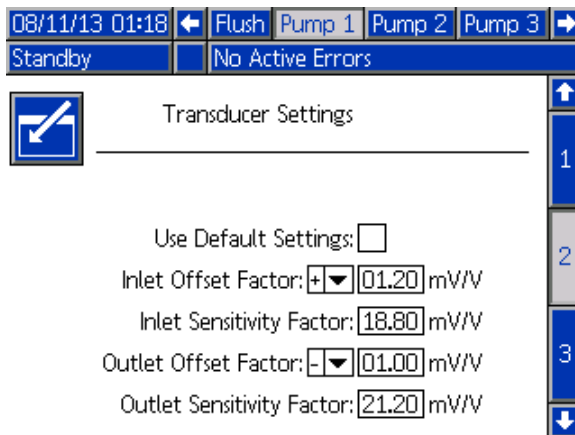

Figure 51 Pump Screen 2, Default Settings Disabled

### Default Settings Selected

When the “Use Default Settings” box is selected, default settings are used for the calibration values, and the fields are grayed out.

### Default Settings Not Selected

When the “Use Default Settings” box is not selected, the following calibration values must be entered. Invalid values will be over-ridden and the system will automatically select the default settings.

- Inlet Offset Factor: This field is only used if **Inlet Pressure** in [Pump Screen 1: Pump Definitions, page 109](#) is set to Monitor; it is grayed out if set to Disabled. The valid range is -01.20 to +01.20 mV/V.
- Inlet Sensitivity Factor: This field is only used if **Inlet Pressure** in [Pump Screen 1: Pump Definitions, page 109](#) is set to Monitor; it is grayed out if set to Disabled. The valid range is 18.80 to 21.20 mV/V.
- Outlet Offset Factor: The valid range is -01.20 to +01.20 mV/V.
- Outlet Sensitivity Factor: The valid range is 18.80 to 21.20 mV/V.

## Pump Screen 3: Pressure Alarms

Pump screen 3 sets the pressure alarm limits for the pump.

When **Inlet Pressure** in [Pump Screen 1: Pump Definitions, page 109](#) is set to Disabled, the inlet limit fields are grayed out and only the outlet limit fields are active. See [Pressure Alarm and Deviation Limits, page 112](#).

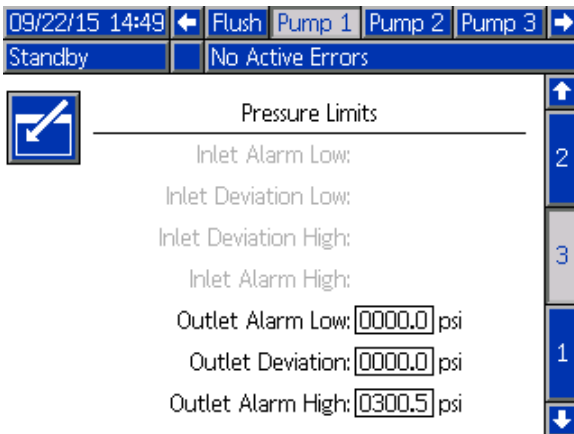

Figure 52 Pump Screen 3, Pressure Monitoring Disabled

When **Inlet Pressure** in [Pump Screen 1: Pump Definitions, page 109](#) is set to Monitor, all fields are active. See [Pressure Alarm and Deviation Limits, page 112](#).

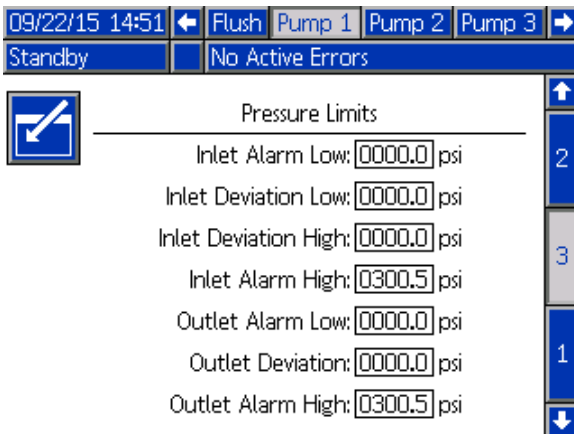

Figure 53 Pump Screen 3, Pressure Monitoring Enabled

## Pressure Alarm and Deviation Limits

Inlet fields are only active if **Inlet Pressure** in [Pump Screen 1: Pump Definitions, page 109](#) is set to Monitor; they are grayed out if set to Disabled. Outlet fields are active at all times.

- Alarm and Deviation ranges are 0-300 psi for low pressure systems, and 0-1500 psi for high pressure systems.
- Setting to 0 will disable the alarm. The Inlet Alarm High and Outlet Alarm High **cannot** be disabled.
- Alarms and Deviations will display when the inlet or outlet pressure drops below the low limit or exceeds the high limit.

**NOTE:** Outlet Alarm Low is only enabled for systems using Flow Control.

## Pump Screen 4: Advanced Configuration

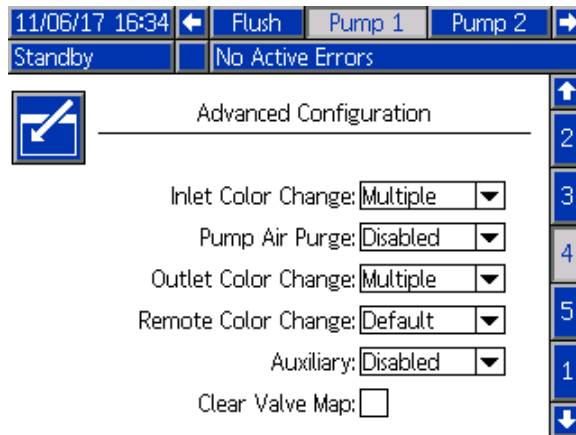

Figure 54 Advanced Pump Configuration Screen

### Inlet Color Change

Select Multiple if each individual material has its own valve on the inlet color stack for a particular pump. Select Single if there is more than one material using a single valve on the inlet color stack (i.e., a piggable system). This option is only available for pumps that have more than one color change material.

**NOTE:** For systems that select Single, it is expected the user knows when a particular material is plumbed and filled to the inlet stack before performing a color change. The PD2K system does not know what material is connected up stream of the inlet valve stack.



### **Pump Air Purge**

Select Enable to add an air purge valve to the pump inlet stack to allow for an air/solvent chop flush of the pump out the dump valve. Select Disable if no air purge valve will be used for the pump. This option is only available for color pumps. See Pump Air/Solvent Chop on [Pump Screen 5, Valve Assignment, page 115](#), for further detail.

### **Outlet Color Change**

Select Multiple if each individual material has its own valve on the outlet color stack for a particular pump. Select Single if there is more than one material using a single hose connected to the outlet color stack. This option is only available for pumps that have more than one color change material.

**NOTE:** If Single is selected, the hose connected to the outlet stack will need to be purged before completing a color change.

### **Remote Color Change**

Select Multiple if each individual material has its own valve on the remote color stack for a particular pump. Select Single if there is more than one material using a single hose connected to the remote color stack. Select Disable if there are no remote color change valves (only solvent and air purge) for the pump. The Disable option is only available if Mix-at-Wall is enabled, and Single is only available for pumps that have more than one color change material.

**NOTE:** Unless Disabled is selected, this must match the selection for Outlet Color Change unless.

**NOTE:** If Single is selected, the hose connected between the outlet stack and remote stack will need to be purged before completing a color change.

**Auxiliary**

Select Enable to add an auxiliary valve downstream of the remote valve stack of the pump. The Auxiliary valve is only opened when that particular pump is dispensing (either mixing or purging). This option is only available if Mix-at-Wall is enabled, and also Multiple Guns is not enabled.

The following figure illustrates an example application of the auxiliary valve. Pumps 1 and 3 both dispense color, but one is solvent based and one is water based. (Pump 2 dispenses a catalyst.) With the auxiliary valves in place for both pumps, only one will flow through the A-side of the remote mix manifold, and the other is completely isolated by the auxiliary valve.

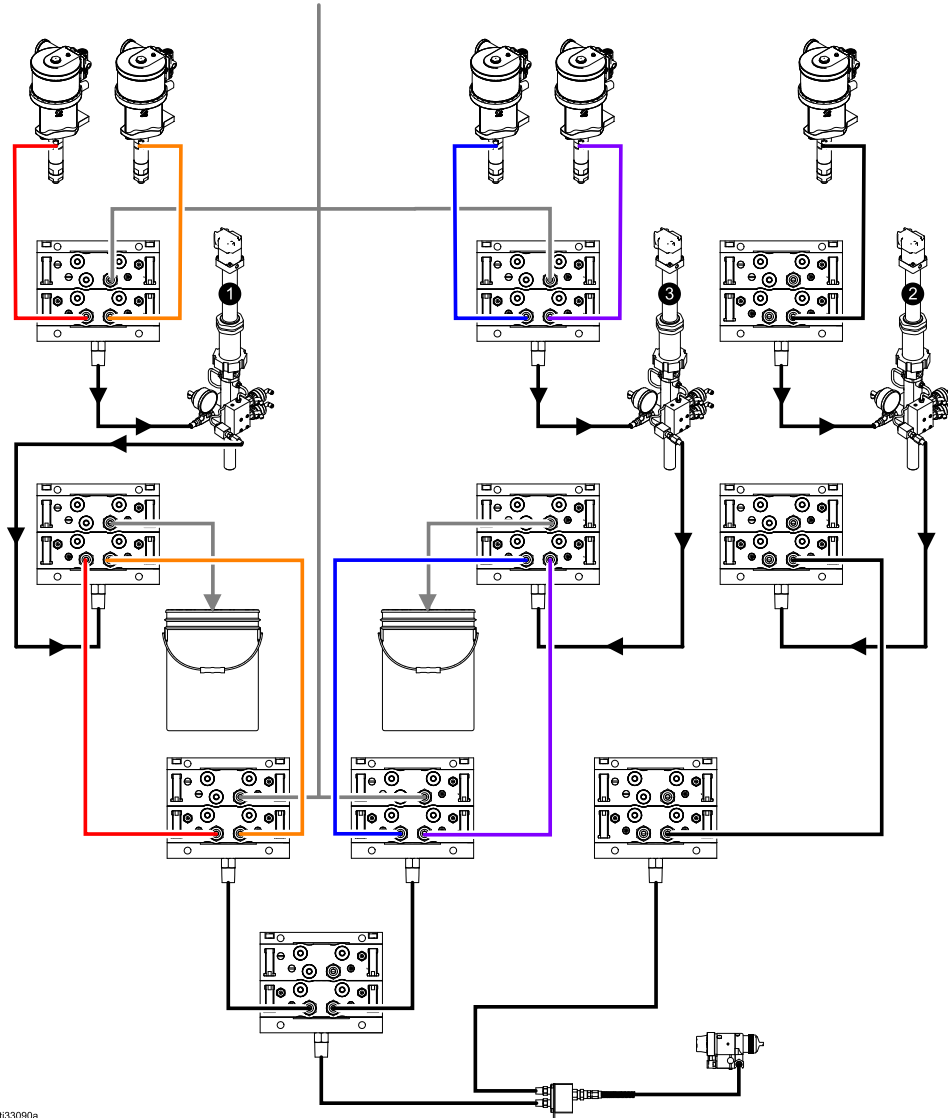

t33090a

Figure 55 Example Application of the Auxiliary Valve

**Clear Valve Map**

Check this box to clear all valve assignments. The user will be prompted to confirm the choice. This will erase any valve assignments permanently, including any that were automatically set based on the static mapping.

### Pump Screen 5, Valve Assignment

11/06/17 17:49		←	Flush	Pump 1	Pump 2	→
Standby		No Active Errors				
	Valve			Location		↑
	Inlet Solvent	1	01			3
	Inlet Color 1	1	02			4
	Inlet Color 2	0	00			5
	Outlet Dump	1	10			1
	Outlet Color 1	1	11			2
	Outlet Color 2	0	00			
	Remote Solvent Gun 1	0	00			
	Remote Color 1	0	00			
	Remote Color 2	0	00			
						↓

Figure 56 Pump Screen 5, Valve Assignment

This screen allows the user to assign each individual color change valve solenoid in the system to a unique

location. The list of valves will automatically populate based on the settings that apply to the pump. A description of the valve includes what stack it belongs to, the material identification, and a specific gun or pump designator, if that applies.

**NOTE:** Some remote stack valves may be shared by more than one pump. They will show up on the valve list for all pumps to which they apply.

All color change valves require a valid location be assigned for the system to be able to operate properly. There are two columns that determine the solenoid location. The left column is the color change module number. This number must be between 1 and 8 and should reflect the dip switch settings on one of the color change boards (see manual 332455 for more details on dip switch settings). The second column is the solenoid location, and this number must be between 1 and 18. The following figure shows the solenoid location enumeration.

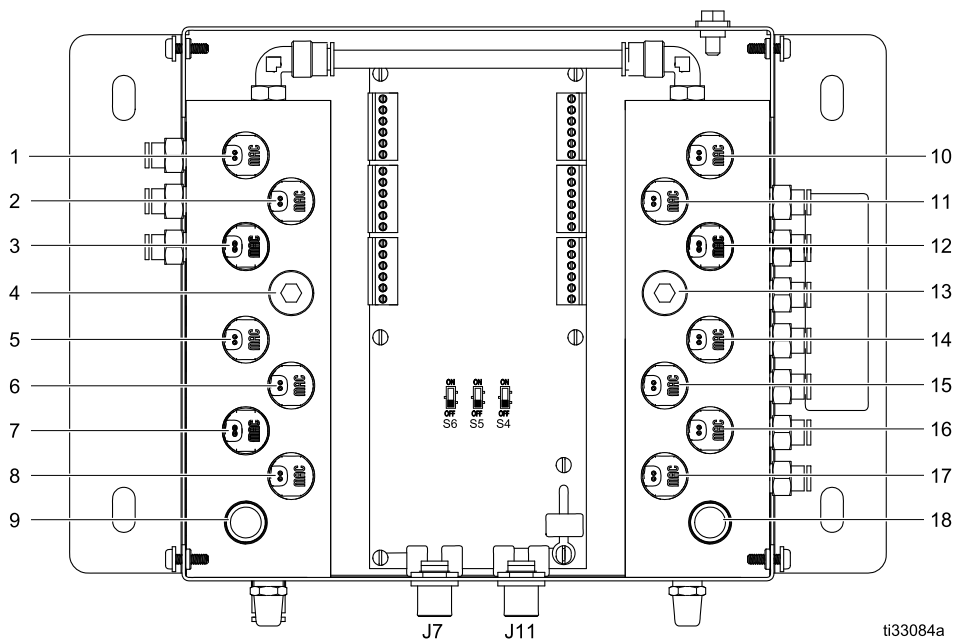

Figure 57 Solenoid Location Enumeration

## Setup Mode Screens

If more than one valve is assigned a valid solenoid location, all instances of that location will be highlighted in red, and are considered invalid.

Valve	Location
Inlet Solvent	1 01
Inlet Color 1	1 02
Inlet Color 2	1 01
Outlet Dump	1 10
Outlet Color 1	1 11
Outlet Color 2	0 00
Remote Solvent Gun 1	0 00
Remote Color 1	0 00
Remote Color 2	0 00

Figure 58 Pump Screen, Valve Assignment with duplicates

A value of 0 for the control module, or 00 for the solenoid, indicates no previous location assignment and both are also invalid assignments.

If a valve location is considered invalid, any operation that uses that valve will be prevented from running. This is easily identified on the Recipe screens. If any of the material's valves are considered invalid, that material will be highlighted red. If any of the valves used in the flush procedure are considered invalid, the flush sequence will be highlighted red.

Recipe: 1	Ratio: 1.00:1
Enabled: <input checked="" type="checkbox"/>	Potlife: 120 min
Color (A): 1	Press. Low Limit: 5 psi
Flush: 1	Target Pressure: 20 psi
Catalyst (B): 1	Press. High Limit: 300 psi
Flush: 2	
Dual Solvent: <input type="checkbox"/>	
Mix Pressure Tolerance: 25 %	

Figure 59 Recipe Screen with invalid valve location

## Pump Air/Solvent Chop

Enabling an air purge valve on the inlet stack of a color pump allows for an air/solvent chop during the pump flush process. The air/solvent chop will replace the wash cycles in a pump flush. Instead, the pump will run at a steady speed for the set number of strokes (full length travel in one direction) while alternating between air and solvent for the desired duty cycles. One pump stroke takes approximately 2 seconds during this phase.

**NOTE:** Air/solvent chop requires additional hardware for the air purge valve. See manual 333282 for kit numbers and installation details.

Flush: 1
Air/Solvent Chop: Pump
Initial Flush: 500 cc
Strokes per Cycle: 1
Air Chop: 2.0 sec
Solvent Chop: 2.0 sec
Final Flush: 500 cc
Gun Purge Time: 10 sec

Figure 60 Flush Screen with pump air/solvent chop

Flush: 1
First Purge: Air
Air/Solvent Chop: Both
Initial Flush: 500 cc
Air Chop: 2.0 sec
Strokes per Cycle: 1
Solvent Chop: 2.0 sec
Total Chop: 20 sec
Final Flush: 500 cc
Final Purge: Solvent

Figure 61 Flush Screen with both air/solvent chops

To enable air/solvent chop for a pump flush, check the Air/Solvent Chop box on the Flush screen. Because air/solvent chop may also be used for purging the gun, if Mix-at-Wall is enabled, the Air/Solvent Chop option becomes a pull-down selection where the user may choose None, Pump, Gun, or Both. If air/solvent chop is enabled for the gun purge, all gun purge parameters will appear on the right side, and pump flush parameters are on the left side. The following parameters apply to the pump flush. For details on air/solvent chop for the gun, see [Flush Screen, page 106](#).

**Air Chop**

Set the air chop duty cycle for the chop phase of the pump flush.

**Solvent Chop**

Set the solvent chop duty cycle for the chop phase of the pump flush.

## Gun Screen 1

Use this screen to set basic applicator parameters.

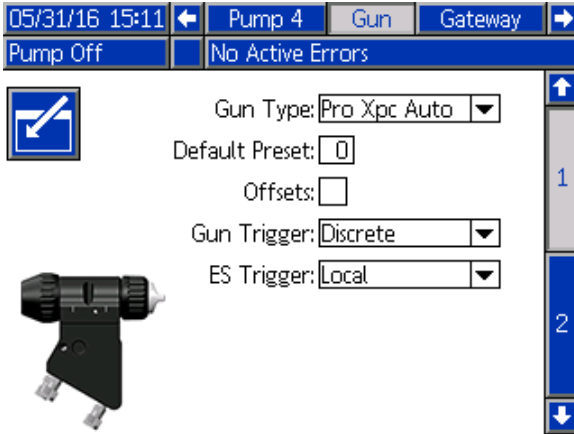

Figure 62 Gun Screen 1, Conventional and Electrostatic Applicators



Figure 63 Gun Screen 1, Rotary Atomizer

### Gun Type

Select the type of applicator used in the system.

- AirPro Auto (Default)
- G40 Auto
- AirPro EFX
- Pro XPc Auto
- ProBell

**NOTE:** Applicator type selection pre-configures the system controllers:

- AirPro Auto (Air Control)
- G40 Auto (Air Control)
- AirPro EFX (Air Control)
- Pro Xpc Auto (Air Control, Electrostatic Control)
- ProBell (Air Control, Speed Control, Electrostatic Control)

### Default Preset

Use the number keypad to set the Preset that will be active when the system powers up. Range=0-98; Default=0.

### Offsets

Check this box to enable users to change the preset target offsets.

**NOTE:** Units of pressure are:

- PSI units of measure: +/- 9
- Bar units of measure: +/- 0.62
- MPa units of measure: +/- 0.062

### Gun/Paint Trigger

Select the method by which the applicator receives the signal to trigger fluid:

- Disabled – The gun/paint trigger is controlled by other equipment in the system.
- Local (Default) – The gun/paint trigger is enabled by pressing the Gun Trigger softkey  on the ADM display. This appears only if manual override is enabled.
- Network – The system triggers the gun/paint in response to a signal received via a PC, PLC, or other networked device.
- Discrete – The system triggers the gun/paint in response to a signal received via a direct, hard-wired connection.

### ES Trigger/Enable (Pro Xpc Auto and ProBell only)

Select the method by which the applicator receives the signal to activate electrostatics:

- Disabled – The electrostatics are activated by other equipment in the system.
- Local (Default) – The electrostatics are activated/deactivated by pressing the Electrostatic softkey  on the ADM display. This appears only if manual override is enabled.
- Network – The system activates the electrostatics in response to a signal received via a PC, PLC, or other networked device.
- Discrete – The system activates the electrostatics in response to a signal received via a direct, hard-wired connection.

### Idle Time (ProBell Only)

Use the number keypad to set the amount of time the ProBell will remain in Spray mode with the paint trigger inactive before the system returns automatically to Idle mode. Range=0–999 minutes; Default=0 minutes (Disable).

**NOTE:** Idle time field is disabled if air controller is disabled. See [Gun Screen 2, page 120](#).

### Idle Speed (ProBell Only)

Use the number keypad to set the desired speed at which the bell cup will rotate when the applicator is in Idle mode. Select a speed lower than your desired spray speed. Range=10–30 kRPM; Default=15 kRPM.

## Gun Screen 2

Use this screen to enable or disable air and electrostatic control by the system, and to set parameters if enabled.

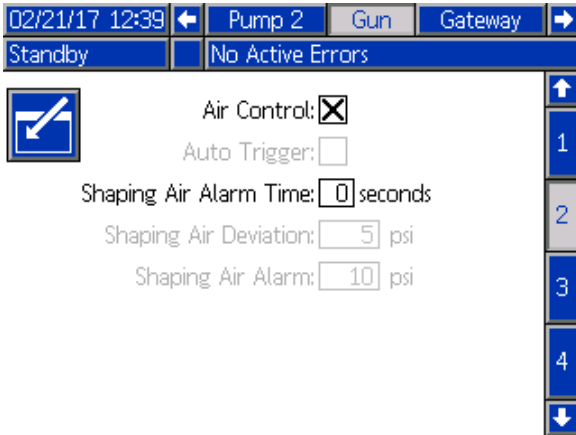

Figure 64 Gun Screen 2

### Air Control

Check this box if your system uses the PD2K Integrated Air Controller.

### Auto Trigger

When the Auto Trigger is enabled, the system will auto trigger the paint trigger when PD2K performs a color change or applicator purge.

To enable or disable this option, the user must log in with password "9999".

**NOTE:** This feature is meant to be used in fixed applicator and reciprocator mounts where the system has to purge into booth.

### Shaping Air Alarm Time

Use the number keypad to set the length of time that the shaping air pressure (atomizing/inner or fan/outer) can be outside of the range before triggering a deviation or alarm. Range=0-60 seconds; Default=0 seconds (Disabled).

### Shaping Air Deviation

This field is active if the Shaping Air Alarm Time is enabled (not 0). Set this field to the amount of pressure above or below the target that will trigger a deviation (does not turn off the equipment). Range=1-99 psi; Default=5.

### Shaping Air Alarm

This field is active if the Shaping Air Alarm Time is enabled (not 0). Set this field to the amount of pressure above or below the target that will trigger an alarm (turns off the equipment). Range=1-99 psi; Default=10.



### Gun Screen 3

Use this screen to enable or disable turbine speed control by the system, and to set parameters.

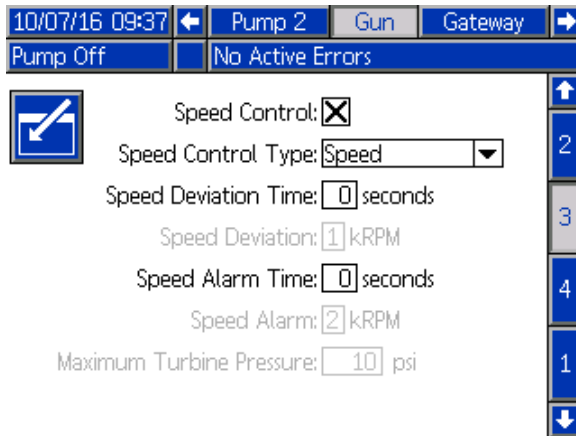

Figure 65 Gun Screen 3

#### Speed Control

Check this box if your system uses the ProBell Speed Controller.

#### Speed Control Type

Select the type of speed control.

- Speed: Uses feedback from the bell to make adjustments to the turbine speed.
- Bypass: Controls the turbine with pressure, but without feedback to the controller from the bell.

<b>NOTICE</b>
In Bypass mode, with no feedback to the controller, take care to monitor turbine speed. Operating in excess of the maximum turbine speed will damage the turbine.

#### Speed Deviation Time

Use the number keypad to set the length of time that the turbine speed can be faster or slower than the target before triggering a deviation (does not turn off the equipment). Range=0-60 seconds; Default=0 seconds (Disabled).

#### Speed Deviation

This field is active if the Speed Deviation Time is enabled (not 0). Set the number of rotations above or below the target that will trigger a deviation error (does not turn off the equipment). Range=1-5 kRPM; Default=1.

#### Speed Alarm Time

Set the length of time that the turbine speed can be faster or slower than the target before triggering an alarm (turns off the equipment). Range=0-60 seconds; Default=0 seconds (Disabled).

#### Speed Alarm

This field is active if the Speed Alarm Time is enabled (not 0). Set the number of rotations above or below the target that will trigger an alarm (turns off the equipment). Range=1-5 kRPM; Default=2.

**NOTE:** The system automatically turns off if speed exceed 65 kRPM.

#### Maximum Turbine Pressure

This field is active only if Bypass is selected for Speed Control Type. Use the number keypad to set the maximum pressure to the turbine. Range=7-80 psi; Default=10 psi.

## Gun Screen 4

Use this screen to enable or disable turbine speed control by the system, and to set parameters.

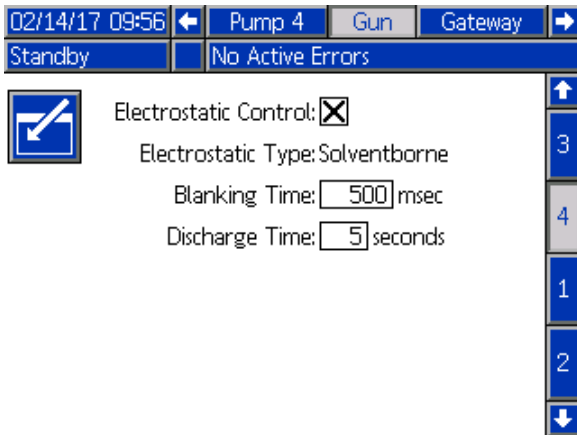

Figure 66 Gun Screen 4

### Electrostatic Control

Check this box to make all electrostatic settings and changes on the ADM screens, rather than on the Electrostatics Controller screens.

### Blanking Time

This is the time between when electrostatics are activated and Arc Detection is enabled. Adjust the Blanking time duration to ensure that the system reaches full voltage during the Blanking time. If arc detection errors occur when the electrostatics are activated, increase the Blanking time or adjust the arc detection parameters to be less sensitive. Range=0.0-2.0 (in 0.1 second increments); Default=0.5.

### Discharge Time

This is the time (in seconds) from when the electrostatics are disabled until the electrostatic voltage is discharged. For most solventborne systems, this setting can remain at 0.0, as no discharge time is needed for a solventborne system.

In a waterborne system, set the discharge timer to a value that will ensure that the system has been discharged.

Range=0.0-60.0 (in 0.1 second increments). Solventborne default is 5.0. Waterborne default is 30.0.

## Gateway Screens

The configuration of your system determines the Gateway Screens that display. The System Logic Controller automatically detects which Graco Gateway is connected to the system, and displays the Gateway Screens accordingly. Graco Gateways available include:

- DeviceNet
- EtherNet I/P
- Modbus TCP
- PROFINET

If your system has no gateway installed, the following screen displays when the Gateway tab is selected.

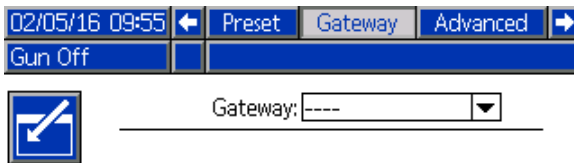

Figure 67 Gateway Screen with No Gateway Connected

### DeviceNet Gateway Screen 1

Use this screen to enter and save DeviceNet configuration information.

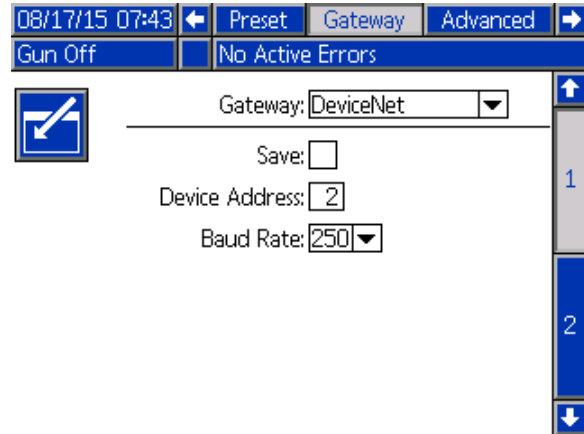

Figure 68 DeviceNet Gateway Screen 1

1. Enter the address used to identify the device on the DeviceNet network (0–63).
2. Select the desired baud rate from the dropdown menu.
  - a. 125 kbps
  - b. 250 kbps
  - c. 500 kbps
3. Check the Save box to write the settings to the Gateway. (Wait) displays on the screen to indicate changes are being applied.

### DeviceNet Gateway Screen 2

This screen displays the hardware revision number, system serial number, map ID, map name, map revision number, and map install date.

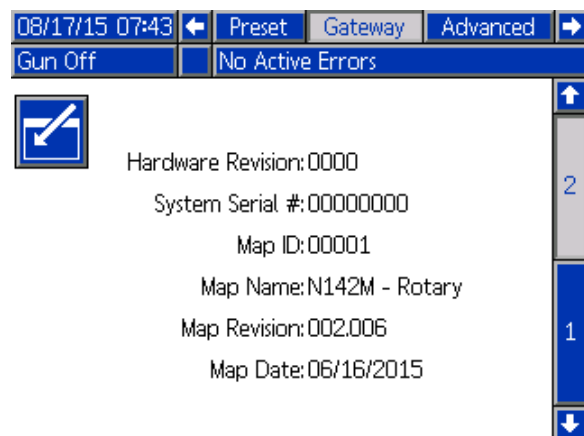

Figure 69 DeviceNet Gateway Screen 2

### EtherNet/IP Gateway Screen 1

Use this screen to enter and save EtherNet/IP configuration information.

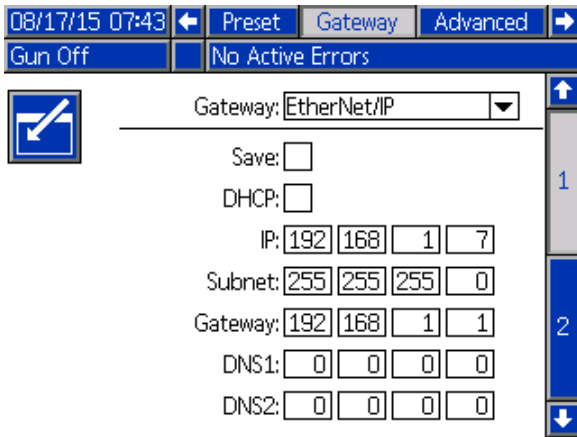

Figure 70 EtherNet/IP Gateway Screen 1

1. Enter the DHCP address, the IP address, the subnet mask, the Gateway address, DNS 1, and DNS 2.
2. Check the Save box to write the settings to the Gateway.

### EtherNet/IP Gateway Screen 2

This screen displays the hardware revision number, system serial number, map ID, map name, map revision number, and map install date.

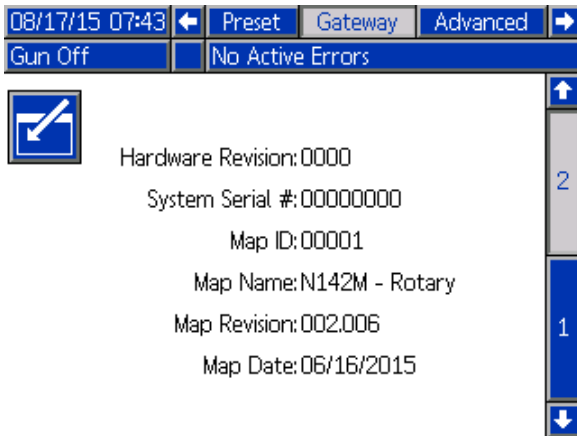

Figure 71 EtherNet/IP Gateway Screen 2

### Modbus TCP Gateway Screen

Use this screen to enter and save Modbus TCP configurations information.

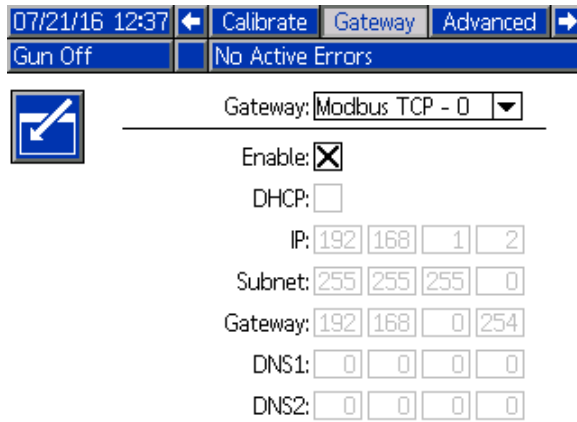

Figure 72 Modbus TCP Gateway Screen

1. Uncheck the Enable box.
2. Enter the DHCP address, the IP address, the subnet mask, the Gateway address, DNS 1, and DNS 2.
3. Check the Enable box to write the settings to the Gateway.

### PROFINET Gateway Screen 1

Use this screen to enter and save PROFINET configurations information.

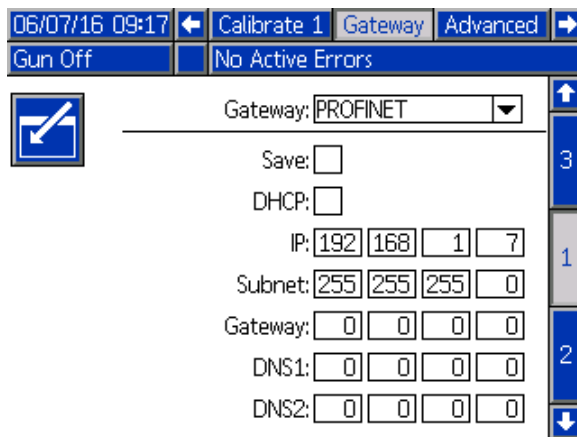

Figure 73 PROFINET Gateway Screen 1

1. Enter the DHCP address, the IP address, the subnet mask, the Gateway address, DNS 1, and DNS 2.
2. Check the Save box to write the settings to the Gateway.

### PROFINET Gateway Screen 2

This screen displays the device address, install date, function tag, and system description.

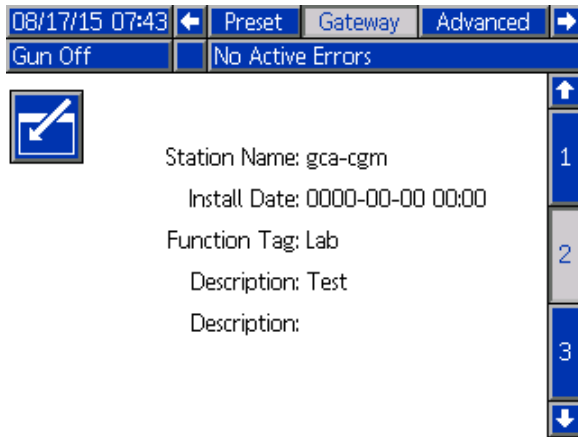

Figure 74 PROFINET Gateway Screen 2

### PROFINET Gateway Screen 3

This screen displays the hardware revision number, system serial number, map ID, map name, map revision number, and map install date.

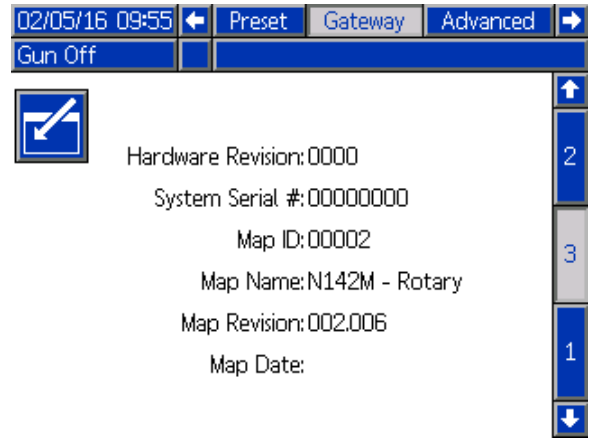



Figure 75 PROFINET Gateway Screen 3

## Calibration Screens

### Calibrate Screen 1

Calibrate Screen 1 initiates a pump pressure check (stall test) for the selected pump. During the test, the Stall Test screen will appear.

The pump and lines must be primed with color or catalyst before doing the stall test. See [System Screen 2, page 97](#) to set test parameters. See [Pump Pressure Check, page 136](#) for complete test instructions.

To initiate the test, press the Pressure Check  button for the desired pump. The system will first check the inlet pressure due to the material supply pressure. If this pressure is greater than 90% of the Stall Test Pressure, the system will generate an alarm and halt the stall test. The pump will build pressure in the line to a minimum of the Stall Test Pressure. The pump will then move to the center stroke position and stall test the upstroke, followed by the downstroke.

**NOTE:** The Last Passed log can only be reset by successfully completing the test.

The screen displays the number of days since the last stall test was passed for each pump.

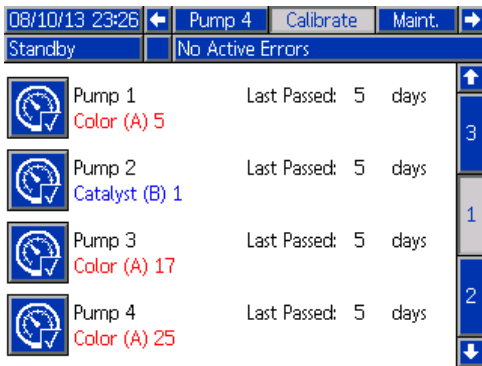

Figure 76 Calibrate Screen 1

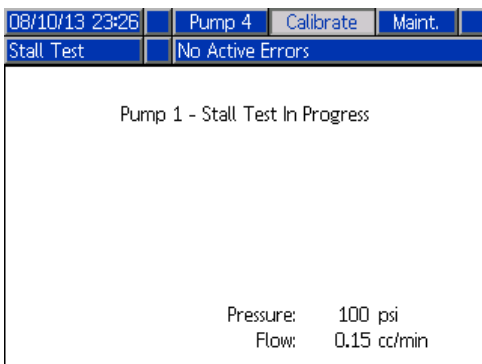



Figure 77 Stall Test Screen

### Calibrate Screen 2

Calibrate Screen 2 initiates a volume test for the selected pump. During the test, the Volume Check screen will appear.

The pump and lines must be primed with color or catalyst before doing the Volume Check. See [Pump Volume Check, page 137](#) for complete test instructions.

To initiate the test, press the Volume Check  button for the desired pump.

The screen displays the volume dispensed. Press  to end the test.

Press and hold the Reset button  for 1-2 seconds to reset the volume counter.



Figure 78 Calibrate Screen 2

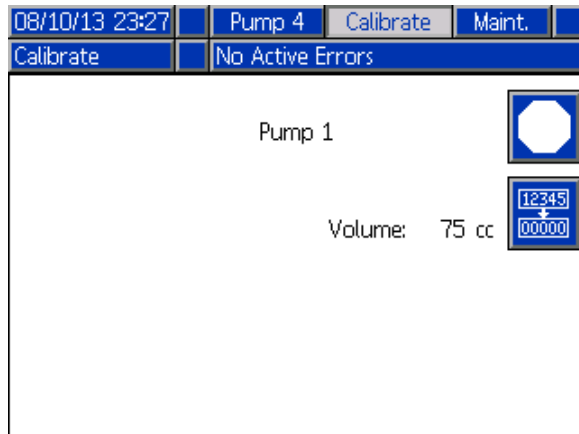



Figure 79 Volume Check Screen



### Calibrate Screen 3

Calibrate Screen 3 initiates a calibration of an accessory solvent meter. During the test, the Volume Verification screen will appear.

The meter and lines must be primed with solvent before doing the calibration. See [Solvent Meter Calibration, page 138](#) for complete instructions.

To initiate the calibration, press the Volume Check  button.

The screen displays the volume dispensed. Enter the amount of solvent dispensed in the Measured Volume field, or press  to end the test.

After the Measured Volume is entered, the Accept Calibration window will appear. Press  to accept the calibration. Press  to cancel the calibration and retain the previous K-factor.

Press and hold the Reset button  for 1-2 seconds to reset the volume counter.

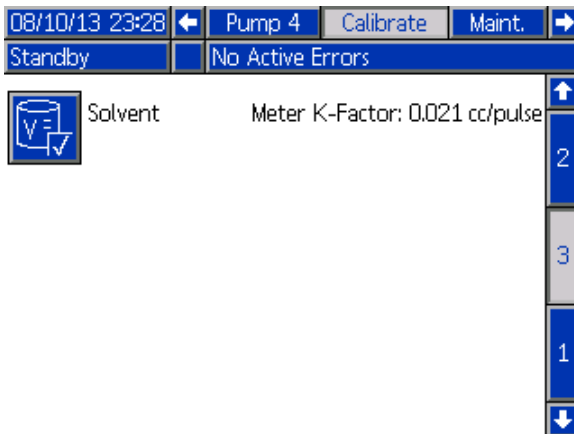

Figure 80 Calibrate Screen 3

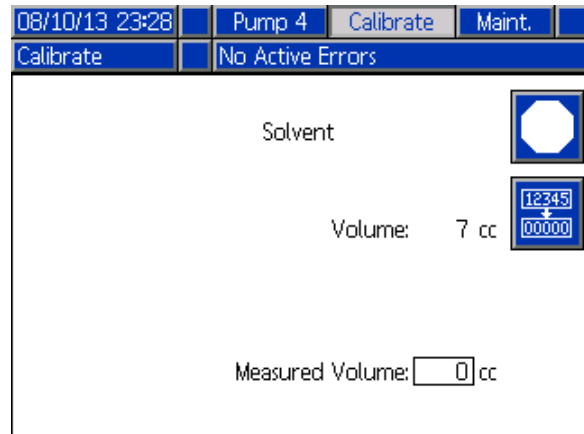

Figure 81 Enter Measured Volume of Solvent

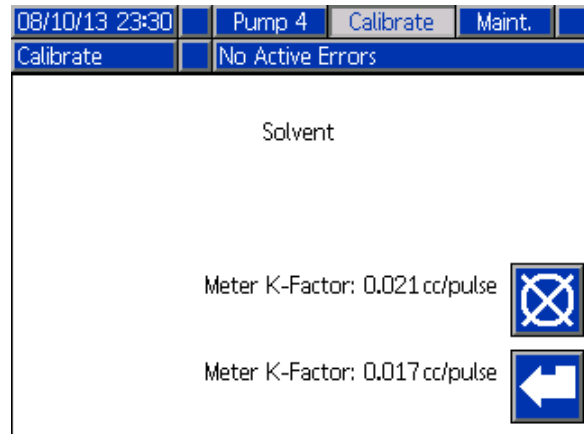

Figure 82 Accept Calibration

## Calibrate Screen 4

### Conventional and Electrostatic Applicators

Calibrate Screen 4 is set up to more accurately display the actual pressure of the V2P. There is some variance from the V2P on the analog output pin. To account for this difference, the user will have to calibrate the voltage that is present on the pin when the V2P is set to 0. Therefore, in order to calibrate the unit, the system has to be in the off state. The softkeys will not appear unless the system is in the off state.

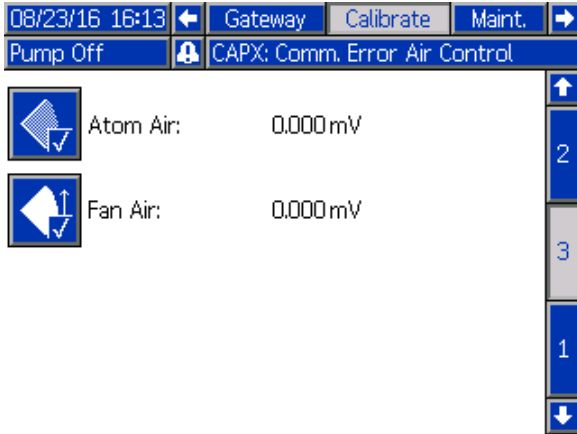

Figure 83 Calibrate Screen 4, Conventional and Electrostatic Applicators

### Rotary Atomizers

Use this screen to calibrate the pressure readings for the inner and outer shaping air and the turbine air.

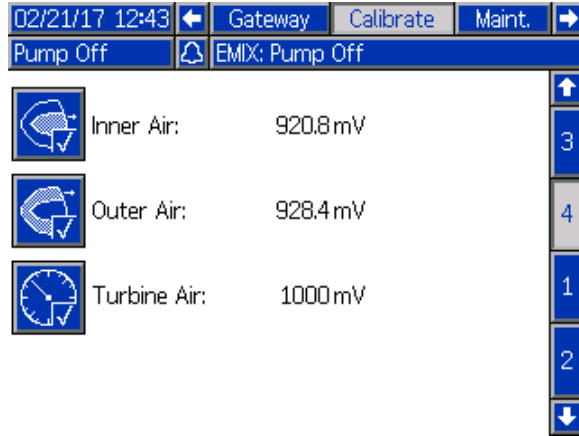

Figure 84 Calibrate Screen 4, Rotary Atomizers

1. Place the system in Gun Off mode.
2. The system must not be under pressure. If needed, follow the **Pressure Relief Procedure** in your ProBell Rotary Applicator manual. See [Related Manuals, page 3](#).
3. To calibrate, press each softkey (Calibrate Inner Air, Calibrate Outer Air, and Calibrate Turbine Air). If Air Control ( [Gun Screen 2, page 120](#)) is disabled, no Inner Air or Outer Air softkey displays. If Speed Control ( [Gun Screen 4, page 122](#)) is disabled, no Calibrate Turbine Air softkey displays.
4. The value on the screen will update if the calibration is successful.

**NOTE:** Calibration is performed at the factory and should only be required when replacing an air regulator or voltage to pressure regulator, or after updating software.



## Maintenance Screens

### Maintenance Screen 1

Use this screen to set maintenance intervals. Set to 0 to disable the alarm.

**NOTE:** The Pump Stall Test cannot be disabled. You must enter a value other than 0.

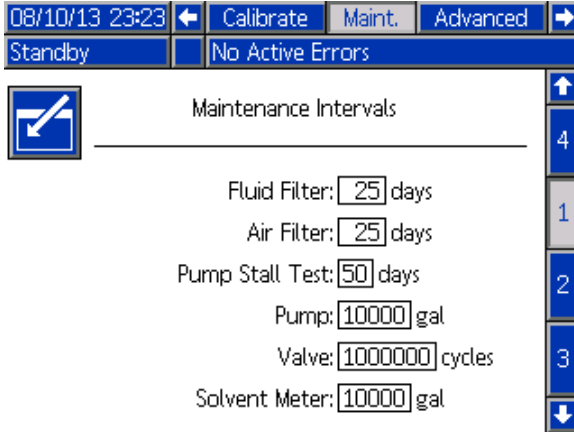



Figure 85 Maintenance Screen 1, Interval Settings

### Maintenance Screen 2

Maintenance Screen 2 shows the current interval status of the solvent meter, fluid filter, and air filter.

Press and hold the Reset button  for 1-2 seconds to clear the alarm and reset the counter.

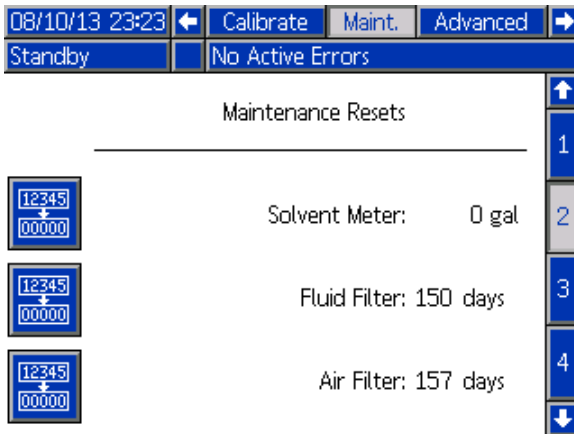



Figure 86 Maintenance Screen 2, Current Status

### Maintenance Screen 3

Maintenance Screen 3 shows the current interval status of the pump maintenance tests.

Press and hold the Reset button  for 1-2 seconds to clear the alarm and reset the counter.

**NOTE:** The Pump Stall Test can only be reset by successfully completing the test.

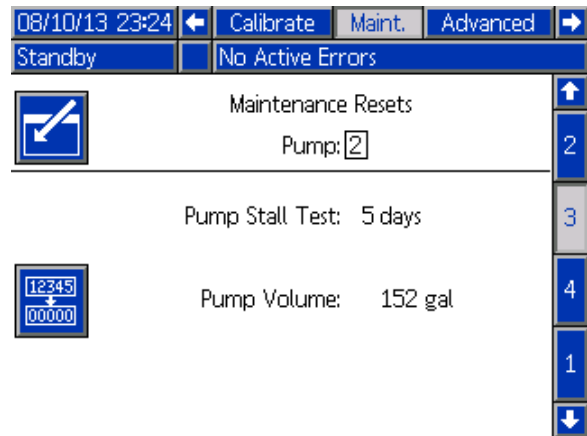



Figure 87 Maintenance Screen 3, Current Pump Status

### Maintenance Screen 4

Maintenance Screen 4 is used to manually relieve pump outlet pressure, or to configure automatic pressure relief.

**NOTE:** Pump outlet pressure relief is only available for pumps that have a dump valve (color change outlet valves).

To manually relieve the pump outlet pressure, change the number in the Pump field to the desired pump and press the Relief softkey .

To set the system to automatically relieve pump outlet pressure, check the Autodump box and set the Pressure Limit. All applicable pumps, while in Standby, will briefly open the dump valve to relieve outlet pressure when the reading climbs above the set Pressure Limit. The system will attempt an autodump up to three times if the pressure does not drop below the set limit.

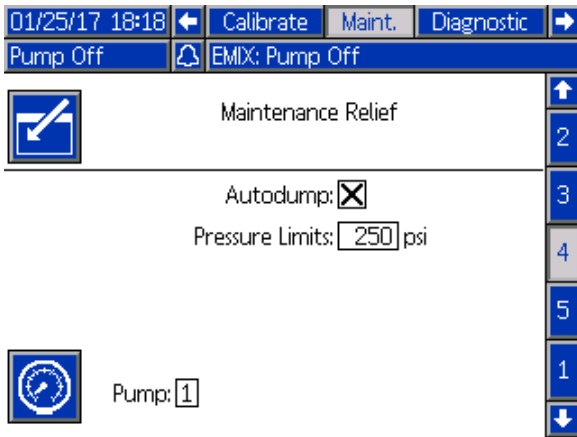



Figure 88 Maintenance Screen 4, Autodump Relief

### Maintenance Screen 5

Maintenance Screen 5 displays cycle counts for a selected color, catalyst, or solvent valve.

Press and hold the Reset button  for 1-2 seconds to reset the counter.

If the system is in Standby, valves can be opened or closed by selecting or deselecting the box for the corresponding valve. Leaving this screen will close all manually-driven valves.

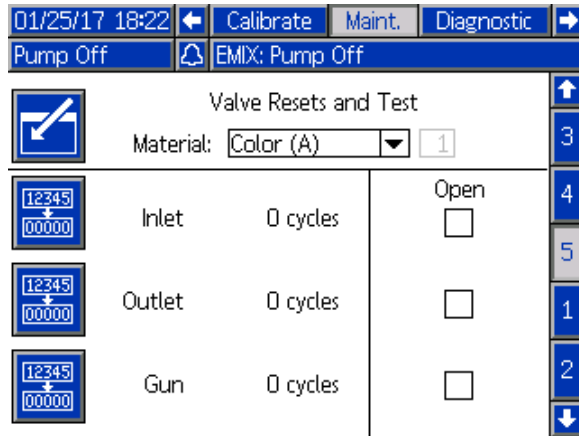

Figure 89 Maintenance Screen 5, Color Valve Resets

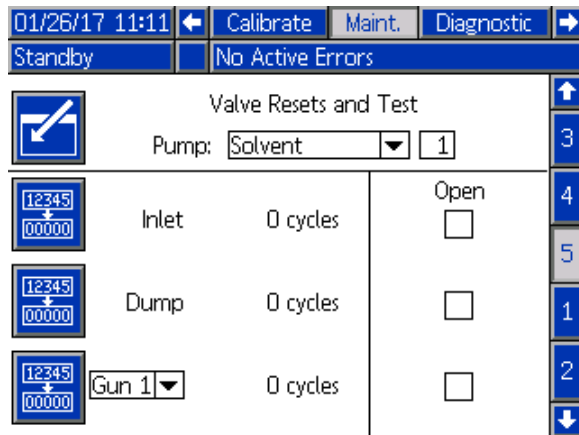

Figure 90 Maintenance Screen 5, Solvent Valve Resets

**NOTE:** In the figure above, the number to the right of “Solvent” is the pump number, not the material number.

### Maintenance Screen 6

Maintenance Screen 6 allows users to test and monitor preventive maintenance schedules for the applicator valves.

When the applicator is not in Gun Off mode, the 'Open' check boxes will be disabled.

When the user leaves edit mode, all solenoids will deactivate.

Maintenance warning is compare to 'Valve' cycles on [Maintenance Screen 1, page 129](#). '0' disables

warnings. Press and hold the Reset button  for 1-2 seconds to clear the alarm and reset the counter.

The screen is disabled when air control is disabled. See [Gun Screen 2, page 120](#).

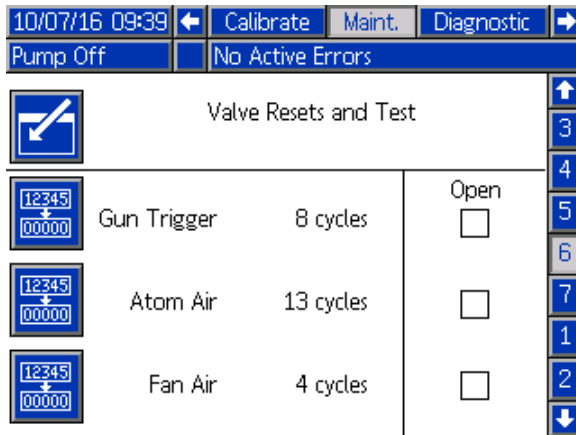

Figure 91 Maintenance Screen 6, Conventional and Electrostatic Applicators

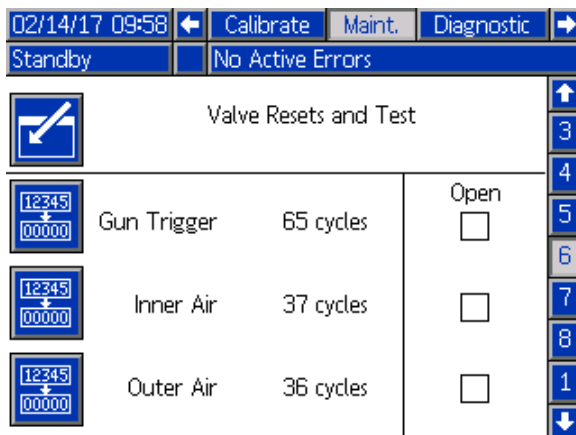

Figure 92 Maintenance Screen 6, Rotary Atomizers

### Maintenance Screen 7

Maintenance Screen 7 allows users to test and monitor preventive maintenance schedules for the applicator valves.

When the applicator is not in Gun Off mode, the 'Open' check boxes will be disabled.

When the user leaves edit mode, all solenoids will deactivate.

Maintenance warning is compare to 'Valve' cycles on [Maintenance Screen 1, page 129](#). '0' disables

warnings. Press and hold the Reset button  for 1-2 seconds to clear the alarm and reset the counter.

The screen is disabled when air control is disabled. See [Gun Screen 2, page 120](#).

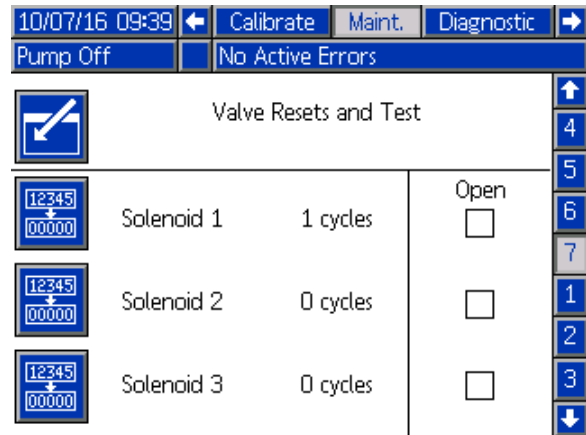

Figure 93 Maintenance Screen 7, Conventional and Electrostatic Applicators

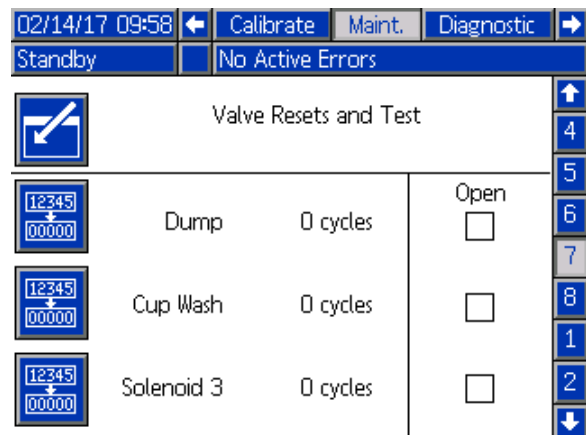

Figure 94 Maintenance Screen 7, Rotary Atomizers

## Advanced Screen 1

Advanced screen 1 sets the following display parameters.

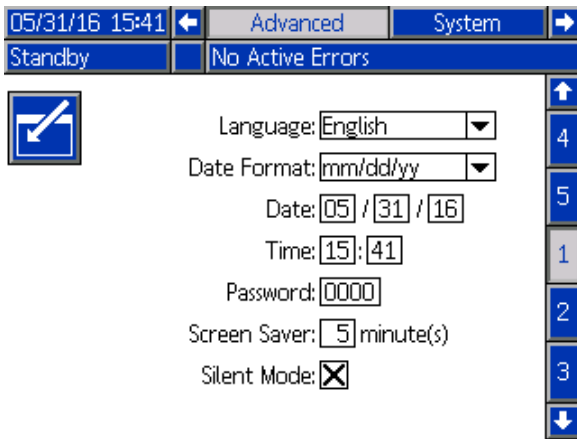

Figure 95 Advanced Screen 1

### Language

Defines the language of the screen text. Select:

- English (default)
- Spanish
- French
- German
- Japanese
- Chinese
- Korean
- Dutch
- Italian
- Portuguese
- Swedish
- Russian

### Date Format

Select mm/dd/yy, dd/mm/yy, or yy/mm/dd.

### Date

Enter the date, using the format selected. Use two digits for the month, day, and year.

### Time

Enter current time in hours (24 hour clock) and minutes. Seconds are not adjustable.

### Password

The password is only used to enter Setup mode. The default is 0000, which means no password is required to enter Setup. If a password is desired, enter a number from 0001 to 9999.

**NOTE:** Be sure to write down the password and keep it in a secure location.

### Screen Saver

Select the desired screen timeout in minutes (00-99). 5 is the default. Select zero (0) to disable the screen saver.

### Silent Mode

Select Silent Mode to disable the alarm buzzer and audible feedback.

## Advanced Screen 2

Advanced screen 2 sets display units (US or metric).

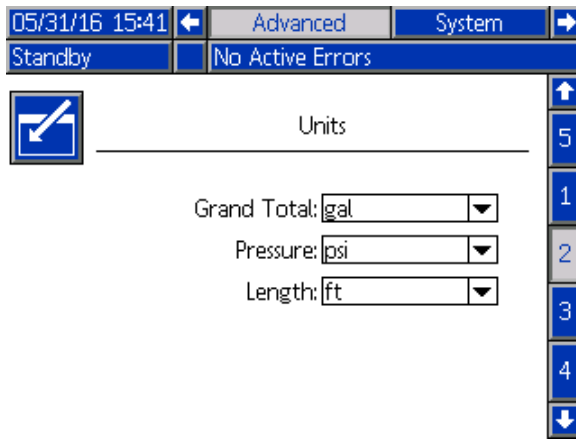

Figure 96 Advanced Screen 2

### Display Units

Select the desired display units:

- Grand Total Volume (US gallon or liter)
- Pressure (psi, bar, or MPa)
- Length (ft or m)

## Advanced Screen 3

Advanced screen 3 enables USB downloads and uploads.

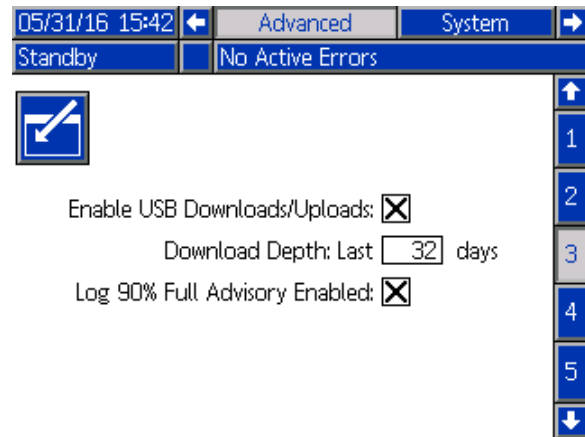

Figure 97 Advanced Screen 3

### Enable USB Downloads/Uploads

Select this box to enable USB downloads and uploads. Enabling USB activates the Download Depth field.

### Download Depth

Enter the number of days for which you want to retrieve data. For example, to retrieve data for the previous week, enter 7.

### Log 90% Full Advisory Enabled

This selection is enabled by default. When enabled, the system will issue an advisory if the memory log has reached 90% of capacity. Perform a download to avoid loss of data.

### Advanced Screen 4

Advanced screen 4 displays the software part numbers and versions for the system components. Additional system components are displayed on Advanced screen 5. This is not an editable screen.

05/31/16 15:42		Advanced	System
Standby		No Active Errors	
Module	Software Part #	Software Version	
Advanced Display	17H005	1.01.005	2
USB Configuration	17H007	1.01.004	3
Fluid Plate	16K460	2.02.004	4
Color Change - 1	16N914	1.01.004	5
Color Change - 2	16N914	1.01.004	1
Color Change - 3	16N914	1.01.004	2
Color Change - 4	16N914	1.01.004	3
Color Change - 5	16N914	1.01.004	4
Color Change - 6	16N914	1.01.004	5
Color Change - 7	16N914	1.01.004	1

Figure 98 Advanced Screen 4

### Advanced Screen 5

Advanced screen 5 displays the software part numbers and versions for additional system components. This is not an editable screen.

05/31/16 15:42		Advanced	System
Standby		No Active Errors	
Module	Software Part #	Software Version	
Color Change - 8	16N914	1.01.004	3
Air Control	17J991	1.01.002	4
Electrostatic Control	17B730	1.03.000	5
Gateway MBTCP - 0	16V799	1.02.001	1
Gateway CGM	15U193	2.06.004	2

Figure 99 Advanced Screen 4

## Diagnostic Screens

### Diagnostic Screen 1

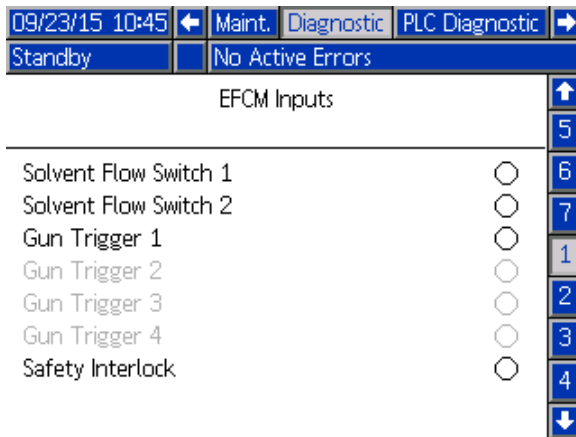

Figure 100 Diagnostic Screen 1

Use this screen to test and verify proper wiring for all inputs to the EFCM. (See installation manual for details.) The screen shows all available inputs to the EFCM, but only highlights those that are relevant to the system configuration. All inputs are normally open. When the input sees a switch closure the status indicator on the screen will turn green.

### Diagnostic Screen 2

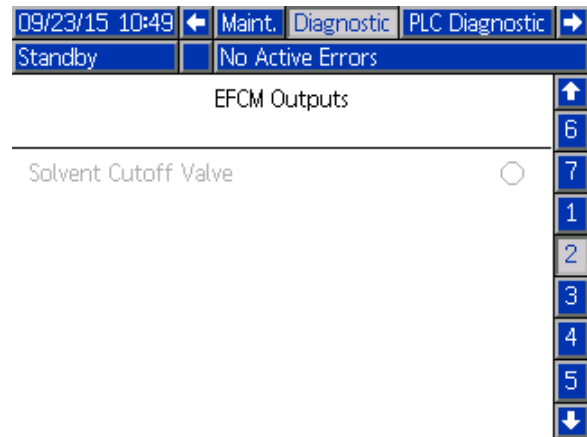

Figure 101 Diagnostic Screen 2

This screen can be used to determine whether any of the EFCM outputs are currently on or off. The screen shows all available outputs from the EFCM, but only highlights those that are relevant to the system configuration. The status indicator next to each output indicates the output is ON when it is green.

### Diagnostic Screens 3–10

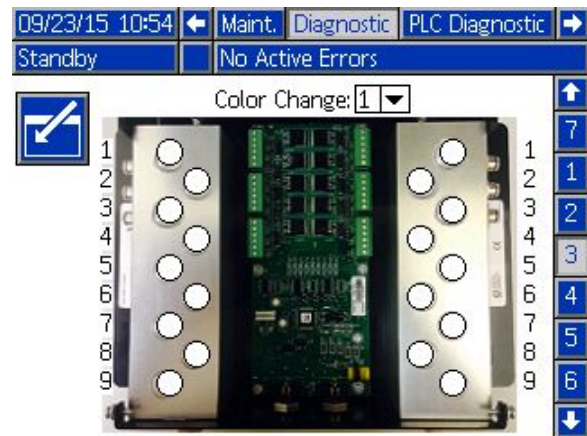

Figure 102 Diagnostic Screen 1

Diagnostic screens 3–10 are only available for color change modules that are currently connected to the PD2K system. These screens provide real time status of the color change valve outputs by changing the status indicator from white to green when the system energizes that solenoid. The user may scroll through the boards with the up and down arrows, or jump directly to a specific color change module by selecting it from the drop-down box.

# Calibration Checks

## Pump Pressure Check

**NOTE:** Enter the transducer calibration data before doing the pressure check.





### Perform the pressure check:

- The first time the system is operated.
- Whenever new materials are used in the system, especially if the materials have viscosities that differ significantly.
- At least once per month as part of regular maintenance.
- Whenever a pump is serviced or replaced.

During each pressure test, the dose valve will close during an up stroke and a down stroke (in either order). This test is to verify that the valves are seating properly and not leaking. If leaking occurs, the system will alarm after the test for that particular pump direction.

**NOTE:** Do not trigger the applicator during the pressure check.



1. The pump and lines must be primed with color or catalyst before doing the Pressure Check. See [Prime and Fill the System, page 26](#).
2. If the display is on a Run Mode screen, press  to access setup screens.
3. Scroll to Calibrate to display [Calibrate Screen 1, page 126](#).
4. Press the Pressure Check  button for the desired pump. The pump will build pressure in the line to a minimum of the Stall Test Pressure. The pump will then move to the center stroke position and stall test the upstroke, followed by the downstroke.
5. The pressure and flow that the unit measured are displayed on the screen. Compare with the maximum leak rate entered on [System Screen 2, page 97](#). If the values are substantially different, repeat the test.

**NOTE:** The stall test pressure set point is a minimum. The system may stall at a higher pressure depending on hose lengths and fluid composition.

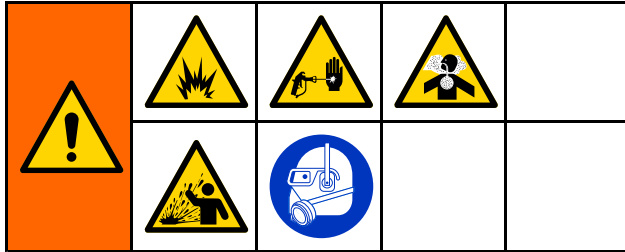

## Pump Volume Check



1. The pump and lines must be primed with color or catalyst before doing the Volume Check. See [Prime and Fill the System, page 26](#).
2. If the display is on a Run Mode screen, press  to access setup screens.
3. Scroll to Calibrate in the menu bar.
4. Scroll to [Calibrate Screen 2, page 126](#).
5. Press the soft key  for the pump you want to check.

**NOTE:** For maximum accuracy, use a gravimetric (mass) method to determine the actual volumes dispensed. Verify that the fluid line is filled and at the proper pressure before checking. Air in the line or pressure that is too high may cause incorrect values.



6. Press the Reset key . The volume counter will reset to 0.
7. Trigger the applicator into a graduated cylinder. Dispense a minimum of 500cc of material.
8. The volume that the unit measured displays on the screen.
9. Compare the amount on the screen to the amount in the graduated cylinder.

**NOTE:** If the value is substantially different, repeat the test. If the dispensed volume and measured volume still do not match, check that the A and B pump positions are not reversed.

**NOTE:** Stop triggering the applicator and press  to cancel the test.

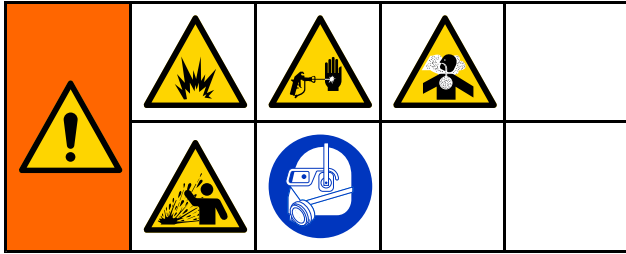

## Solvent Meter Calibration



1. The meter and lines must be primed with solvent before doing the calibration. See [Prime and Fill the System, page 26](#).
2. If the display is on a Run Mode screen, press  to access setup screens.
3. Scroll to Calibrate in the menu bar.
4. Scroll to [Calibrate Screen 3, page 127](#).
5. Press the soft key  to initiate the calibration.

**NOTE:** For maximum accuracy, use a gravimetric (mass) method to determine the actual volumes dispensed.

**NOTE:** Verify that the fluid line is filled and at the proper pressure before calibrating. Air in the line or pressure that is too high may cause incorrect calibration values.

6. Trigger the applicator into a graduated cylinder. Dispense a minimum of 500cc of material.
7. The volume that the unit measured displays on the screen.
8. Compare the amount on the screen to the amount in the graduated cylinder.  
**NOTE:** If the value is substantially different, repeat the calibration process.
9. Enter the amount of solvent dispensed in the Measured Volume field on the screen.
10. After the measured volume is entered, the controller calculates the new solvent meter K-factor and displays it on the screen. The standard meter K-factor is 0.021 cc/pulse.
11. Press  to accept the calibration. Press  to cancel the calibration and retain the previous K-factor.

## Color Change

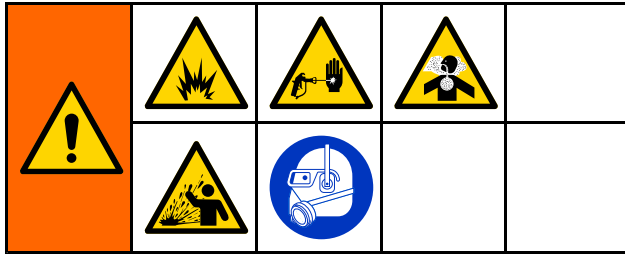

Color Change Module Kits are available as an accessory. See manual 333282 for complete information.

### Multiple Color Systems

1. Command the system to Standby.
2. Enable Manual Override on [System Screen 5, page 102](#).
3. Select the new recipe on the [Spray Screen, page 85](#). This will change colors in the pump and initiate an applicator purge.
4. The system will purge material B then material A out of the applicator. Each material will purge for the amount of time designated by the Flush Sequence selected for each material on the [Recipe Screen, page 104](#).
5. Wait for the color change to complete. The system automatically goes from Color Change to Mix Fill and the remote mix manifold automatically selects the correct color.
6. Trigger the applicator to complete the Mix Fill.
 

**NOTE:** There is a 10 second delay without flow before the system will fault.
7. Wait for the system to complete the Mix Fill operation. Command the system to Mix and begin spraying..

## System Errors

System errors alert you of a problem and help prevent off-ratio spraying. There are three types: Advisory, Deviation, and Alarm.

An **Advisory** records an event in the system, and will clear itself after 60 seconds. The four-digit error code will be followed by '-V'.

A **Deviation** records an error in the system but does not shut down the equipment. The deviation must be acknowledged by the user. The four-digit error code will be followed by '-D'.

If an **Alarm** occurs, operation stops. The four-digit error code will be followed by '-A'.

If any of the system error types occur:

- Alarm buzzer sounds (unless in silent mode).
- Alarm popup screen shows the active alarm code (see [Error Codes, page 141](#)).
- Status bar on the Advanced Display Module shows the active alarm code.
- Alarm is saved in the date/time stamped log.

A **Record** saves relevant system events in the background. These are informational only and can be reviewed on the Events screen, which displays the 200 most recent events, with date, time, and description.

## To Clear Error and Restart

**NOTE:** When a deviation or alarm occurs, be sure to determine the error code before resetting it. If you forget which code occurred, go to the [Errors Screen, page 95](#), to view the last 200 errors, with date and time stamps.

If an alarm has occurred, correct the cause before resuming operation.

To acknowledge a deviation or clear an alarm, press



on the Advanced Display Module. Users also may acknowledge and clear errors via a network device. [INPUT REGISTER 08: Clear Active Alarm in ProMix PD2K Network Inputs, page 46](#).

## Gun Trigger Input Function

The Gun Trigger Input signals the controller when the applicator is triggered. The applicator icon on the Advanced Display Module shows spray when the Gun Trigger Input is activated.

If a pump fails, pure resin or catalyst could spray indefinitely if the unit does not detect the condition and intervene, which is why the Gun Trigger Input is so important.

If the unit detects through the Gun Trigger Input signal that the applicator is triggered, yet one or both of the pumps are not running, a Flow Not Detected Alarm (F8D1) occurs after 10 seconds (default) and the system goes into Standby.

## Error Codes

**NOTE:** When an error occurs be sure to determine the code before resetting it. If you forget which code occurred, use the [Errors Screen, page 95](#) to view the last 200 errors, with date, time, and description.

### General Error Code Tables

#### Purge Errors

Code	Type	Description	Problem	Cause	Solution
ETE0	Record	Purge Not Complete	The system was unable to complete a purge sequence.	An indication that the system either could not complete or was interrupted before completing a applicator purge.	No action required.
SPD1	Alarm	Applicator Purge Incomplete	The system timed out without reaching the user-specified volume of solvent for a purge.	Solvent flow switch not working.	Replace switch.
				Solvent flow is too low to actuate the solvent switch.	Increase solvent pressure to drive a high purge flow rate
				Applicator is not triggered.	Operator must continue flushing for configured time, until the booth control indicates purge is completed.
				Mix manifold was not set to flush position, blocking solvent flow to the spray applicator.	Set manifold to flush position.

System Errors

Mix Errors

Code	Type	Description	Problem	Cause	Solution
F7S1	Alarm	Flow Detected Solvent Applicator	The solvent flow switch is indicating unexpected solvent flow.	Solvent flow switch is stuck in flow position.	Clean or replace switch.
				There is a leak through the solvent cutoff valve.	Check for leaks and repair valve.
F7S2	Alarm	Flow Detected Solvent Mix	The solvent flow switches indicate that both are flowing solvent at the same time.	One or both solvent flow switches are stuck in flow position.	Clean or replace the switch(es).
				There is a leak through one or both of the solvent cutoff valves.	Check for leaks and repair valve(s).
QPD1	Alarm, then Deviation	Potlife Expired	Potlife time has expired before the system has moved the required amount of material (potlife volume) through the mixed material line.	Purge process was not completed.	Make sure purge process is completed.
				Solvent supply shut off or empty.	Verify solvent supply is available and on, supply valves are open.
QP##	Deviation	Potlife Expired Recipe ##	Potlife time has expired before the system has moved the required amount of material (potlife volume) through the mixed material line in an inactive applicator loaded with recipe ##. *This only applies to systems with multiple applicators.	An inactive applicator has mixed material for recipe ## loaded and has not dispensed enough material in the required amount of time.	Purge the inactive applicator.
SND1	Alarm	Mix Fill Incomplete	The system timed out before the mix fill cycle loaded the applicator with mixed material.	Mix manifold not set to spray position.	Set manifold to spray.
				Spray applicator was not triggered.	Allow flow through applicator during fill process until the fill complete LED stops flashing.
				Restrictions in mixer, manifold, or spray applicator.	Fix restrictions.

## Pumping Errors

**NOTE:** In some error codes listed below, a # symbol is shown as the last digit. This symbol represents the applicable component number, which can vary. The unit's display will show the applicable number as the last digit in the code. For example, the F1S# code listed in this table will be displayed as F1S1 if the affected component is pump 1, F1S2 for pump 2, and so on.

Code	Type	Description	Problem	Cause	Solution
DA0#	Alarm	Exceeded Maximum Flow Pump #	Pump was driven to its maximum allowed speed.	System has a leak or open valve that is allowing unrestricted flow.	Inspect system for leaks.
				Pump is cavitating, cycling without restriction.	Verify that the pump is being supplied with material.
				Viscosity of material is too thin for nozzle size.	Reduce nozzle size to create more restriction. Reduce paint pressure to lower the flow rate.
				System pressure or Flow Set Point is too high (causing the pump to work too hard).	Reduce the pressure or the Flow Set Point.
DE0#	Alarm	Leak Detected Pump #	This is a manual stall test failure when the pump cannot build pressure to the target "Stall Test Pressure." Will fault after 30 seconds.	No material in the pump or line.	Make sure the pump and down stream color line are loaded with material.
				Leak in the system.	Determine if leak is external or internal by visually inspecting the system for fluid leakage. Fix all loose or worn hoses, fittings, and seals. Inspect all valve seats and needles for wear, and replace worn piston or throat seals.
DF0#	Alarm	No Stall Up Pump #	Pump failed the stall test; did not stall on the upstroke.	Valve failure, seal failure, worn rod or cylinder.	Replace inlet and outlet valve and seal for up stroke. Replace piston and throat seals. Replace rod and cylinder as necessary.
DG0#	Alarm	No Stall Down Pump #	Pump failed the stall test; did not stall on the downstroke.	Valve failure, seal failure, worn rod or cylinder.	Replace inlet and outlet valve and seal for down stroke. Replace piston and throat seals. Replace rod and cylinder as necessary.

System Errors

Code	Type	Description	Problem	Cause	Solution
DH0#	Alarm	No Stall Pump #	Pump failed the stall test; did not stall on either the upstroke or the downstroke.	Valve failure, seal failure, worn rod or cylinder.	Replace inlet and outlet valve and seal for up and down strokes. Replace piston and throat seals. Replace rod and cylinder as necessary.
DK0#	Alarm	Position Pump #	Pump was detected to be out of position.		Re-enable pump power to reset pump. Make sure inlet supply pressure is not too high.
EBH#	Record	Home Complete Pump #	Record of pump homing is complete.	An indication on the display that the pump completed the home function	No action required.
EF0#	Alarm	Timeout Startup Pump #	Pump tried but was not able to move to the home position within a specified amount of time.	Pump dose valves did not actuate.	Verify air pressure to solenoid valves. Verify the valves are actuating.
				Motor could not drive pumps and linear actuator.	Verify motor is driving the pump.
				Pump stroke length is shortened by mechanical system tolerance.	Verify correct assembly of linear actuator and pump piston rods. See pump manual.
EF1#	Alarm	Timeout Shutdown Pump #	Pump tried but was not able to move to the park position within a specified amount of time.	Pump dose valves did not actuate.	Visually inspect valves to ensure they are operating properly; verify they have air pressure above 85 psi (0.6 MPa, 6.0 bar).
				Pump is filled with thick paint and could not drive piston to end of stroke. Motor or drive is worn or damaged.	Observe motor and drive assembly to verify that the motor is generating force.
F1D#	Alarm	Flow Low Mix Pump #	The pump was unable to maintain it's target flow rate.	There is a restriction in the hose or applicator that is preventing the pump from dispensing at it's target rate.	Check that the applicator is triggered and for restrictions in the hose.



Code	Type	Description	Problem	Cause	Solution
F1F#	Alarm	Flow Low Fill Pump #	There has been no flow or low flow during a pump fill operation.	There is a restriction on the outlet side of the pump or color stack.	Make sure there are no restrictions in the color stack and that the dump valve is actuating.
				Thick viscosity paint requires more pressure to pump.	Increase non-mix pressure if necessary to create flow during the fill function.
				The pumps do not have to move for the system to build enough pressure to meet the set point.	Increase non-mix pressure if necessary to create flow during the fill function.
F1S#	Alarm	Flow Low Purge Pump #	There has been no flow or low flow during a pump purge operation.	Restriction in the outlet side of the pump or color stack resulting in the solvent flow being too low.	Make sure there are no restrictions in the system. Increase non-mix pressure if necessary to create flow during the purge function.
F7D#	Alarm	Flow Detected Pump #	The pump flow exceeded 20 cc/min flow coming into Idle mode.	There is a leak in the system or the applicator was open when the system went into Idle mode.	Verify there are no leaks in the system. Make sure the air flow switch is actuating properly. Do not trigger the applicator without atomizing air.
F8D1	Alarm	Flow Not Detected	No flow while mixing.	Restriction in the outlet side of the pump or color stack.	Make sure there are no restrictions in the system.
F9D#	Alarm	Flow Unstable Pump #	The pump flow rate did not stabilize while entering Idle mode.	Potential leak in the system.	Check the system for leaks and run manual stall test.

## System Errors

### Pressure Errors

**NOTE:** In some error codes listed below, a # symbol is shown as the last digit. This symbol represents the applicable component number, which can vary. The unit's display will show the applicable number as the last digit in the code. For example, the P6F# code listed in this table will be displayed as P6F1 if the affected component is pump 1, P6F2 for pump 2, and so on.

Code	Type	Description	Problem	Cause	Solution
F6F#	Alarm	Press. Sens. Removed Inlet #	No inlet pressure transducer is detected when the system is expecting one.	Disconnected transducer.	Verify transducer is connected properly. Replace if reconnecting does not eliminate the alarm.
P1D#	Alarm	Pressure Low Outlet Pump #	The outlet pressure on pump # is less than the user-entered alarm limit. *This alarm is only enabled with Flow Control.	There is no fluid pressure or pump is cavitating.	Check supply for pump #, increase supply pressure.
P1F#	Alarm	Pressure Low Inlet Pump #	The inlet pressure on pump # is less than the user-entered alarm limit.		Increase inlet pressure.
P2F#	Deviation	Pressure Low Inlet Pump #	The inlet pressure on pump # is less than the user-entered deviation limit.		Increase inlet pressure.
P3D#	Deviation	Pressure High Outlet Pump #	The outlet pressure on pump # is greater than the user entered deviation limit.		Relieve system pressure.
P3F#	Deviation	Pressure High Inlet Pump #	The inlet pressure on pump # is greater than the user-entered deviation limit.		Decrease inlet pressure.
P4D#	Alarm	Pressure High Outlet Pump #	The outlet pressure on pump # is greater than the user entered alarm limit.		Relieve system pressure.
P4F#	Alarm	Pressure High Inlet Pump #	The inlet pressure on pump # is greater than the user-entered alarm limit.		Decrease inlet pressure.
P4P#	Alarm	Pressure High Supply Pump #	The supply pump fluid pressure for pump # is greater than 90% of the user-entered Stall Test Pressure.	The supply pump pressure is too high.	Check supply for pump #, decrease supply pressure.
P6D#	Alarm	Press. Sens. Removed Outlet #	No outlet pressure transducer is detected when the system is expecting one.	Disconnected transducer.	Verify transducer is connected properly. Replace if reconnecting does not eliminate the alarm.

Code	Type	Description	Problem	Cause	Solution
P6F#	Alarm	Press. Sens. Removed Inlet #	No inlet pressure transducer is detected when the system is expecting one.	Disconnected transducer.	Verify transducer is connected properly. Replace if reconnecting does not eliminate the alarm.
P9D#	Alarm	Press. Sens. Failed Outlet #	Outlet pressure transducer has failed.	Outlet pressure transducer has failed or the pressure is above the readable range.	Relieve system pressure. Verify connections, or replace if reconnecting does not eliminate the alarm.
P9F#	Alarm	Press. Sens. Failed Inlet #	Inlet pressure transducer has failed.	Inlet pressure transducer has failed or the pressure is above the readable range.	Relieve system pressure. Verify connections, or replace if reconnecting does not eliminate the alarm.
QADX	Alarm	Differential Pressure A Over B	Low differential pressure. This alarm is active only during Mix mode.	There is a leak on the B side.	Check the system for internal and external leaks on all catalyst manifolds and plumbing.
				The B side pump is cavitating.	Check paint supply on the B side, increase paint supply pressure.
QBDX	Alarm	Differential Pressure B Over A	High differential pressure. This alarm is active only during Mix mode.	There is a leak on the A side.	Check the system for internal and external leaks on all color manifolds and plumbing.
				The A side pump is cavitating.	Check paint supply on the A side, increase paint supply pressure.

System Errors

System Errors

Code	Type	Description	Problem	Cause	Solution
EB00	Record	Stop Button Pressed	Record of a stop button press.	Indicates system stop key on ADM was pressed.	n/a
EC00	Record	Setup Value(s) Changed	Record of changing setup variables.	Indicates date and time when setup values were changed.	n/a
EL00	Record	System Power On	Record of power cycle (ON).	Indicates date and time when system was started.	n/a
EM00	Record	System Power Off	Record of power cycle (OFF).	Indicates date and time when system was turned off.	n/a
EMIX	Advisory	Pump Off	The pumps are not powered and are unable to move.	Pump power was turned off or an error occurred.	Start pumps by pressing pump start key on Advanced Display module.
ES00	Advisory	Factory Defaults	Record of defaults being loaded.		n/a
WSN1	Alarm	Config Error Color	A color defined for the system is not assigned to any applicator. *This only applies to systems with multiple applicators.	One or more colors is missing a valid applicator assignment.	Ensure all colors for all color pumps have a applicator assigned to them on Pump Screen 4.
WSN2	Alarm	Config Error Catalyst	A catalyst defined for the system has an invalid applicator assignment. *This only applies to systems with multiple applicators.	One or more catalyst is missing a valid applicator assignment.	Ensure all catalysts for all catalyst pumps have an applicator assigned to them on Pump Screen 4.
				Too many catalyst applicator assignments exist.	The total number of catalyst applicator assignments for the system may not exceed four.

## Communication Errors

**NOTE:** In some error codes listed below, a # symbol is shown as the last digit. This symbol represents the applicable component number, which can vary. The unit's display will show the applicable number as the last digit in the code. For example, the CAC# code listed in this table will be displayed as CAC1 if the affected component is color change board 1, CAC2 for board 2, and so on.

Code	Type	Description	Problem	Cause	Solution
CA0X	Alarm	Comm. Error ADM	System does not detect the Advanced Display Module (ADM).	This communication error indicates that the Network has lost communication with the Advanced Display Module.	Check CAN cable connecting ADM to the EFCM.
CAC#	Alarm	Comm. Error Color Change #	System does not detect the Color Change Module #.	This communication error indicates that the network has lost communication with the Color Change Module #.	Check CAN cable connections to the Color Change Module # and any interconnected modules.
CADX	Alarm	Comm. Error Fluid Module	System does not detect the Enhanced Fluid Control Module (EFCM).	This communication error indicates that the Network has lost communication with the EFCM.	Check CAN cables connecting ADM to the EFCM. Replace Cable or EFCM as necessary.
CAGX	Alarm	Comm. Error Gateway	System does not detect a CGM that was registered as being connected at power up.		
CAG#	Alarm	Comm. Error Modbus Gateway	System does not detect a Modbus CGM that was registered as being connected at power up.	The Modbus CGM address dial was changed while the system was powered up.	Unplug the Modbus CGM from the CAN network and re-plug it back in so that it re-registers with the new address.
				The Modbus CGM is not connected/failed.	Check that the Modbus CGM is properly connected to the CAN network and it's LEDs indicate it is powered.
CAI0	Alarm	Comm. Error ES Control	System doesn't detect the electrostatic controller on the CAN network.		Verify CAN cable connections.
					Verify Pro Xpc Auto Controller is powered up.
					Verify Pro Xpc Auto Controller is setup for CAN communication (see Setup Screen P02 in manual 333266).

System Errors

Code	Type	Description	Problem	Cause	Solution
CAI1	Alarm	Comm. Error ES Control	System doesn't detect the electrostatic controller on the CAN network.		Verify CAN cable connections.
					Verify ProBell Auto Controller is powered up.
					Verify ProBell Auto Controller is setup for CAN communication (see Setup Screen P02 in manual 3A3657).
CAKX	Alarm	Comm. Error Speed Control	System can't find the speed control module on the CAN network.		Verify CAN cable connections bottom of speed control.
					Check status LEDs on FCM cube.
					Cycle power.
CAPX	Alarm	Comm. Error Air Control	System can't find the air control module on the CAN network.		Verify CAN cable connections bottom of air control.
					Check status LEDs on FCM cube.
					Cycle power.
CDC#	Alarm	Duplicate Color Change #	System detects two or more identical Color Change Modules.	More than one Color Change Module with the same address is connected in the system .	Check the system and remove the extra color change module.
CDDX	Alarm	Duplicate Fluid Module	System sees two or more identical Enhanced Fluid Control Modules (EFCM).	More than one EFCM is connected in the system.	Check the system and remove the extra EFCM.
CDI0	Alarm	Duplicate Xpc Electrostatic Control	System detected two electrostatic controls with the same ID on the CAN network.		The electrostatic control has the same CAN ID as another module. System only supports one air control. Remove module from network.
CDI1	Alarm	Duplicate ProBell Electrostatic Control	System detected two electrostatic controls with the same ID on the CAN network.		The electrostatic control has the same CAN ID as another module. System only supports one air control. Remove module from network.

<b>Code</b>	<b>Type</b>	<b>Description</b>	<b>Problem</b>	<b>Cause</b>	<b>Solution</b>
CDKX	Alarm	Duplicate Speed Control	System detected two speed controls with the same ID on the CAN network.		The speed control has the same CAN ID as another module. System only supports one speed control. Remove module from network.
CDPX	Alarm	Duplicate Air Control	System detected two air controls with the same ID on the CAN network.		The air control has the same CAN ID as another module. System only supports one air control. Remove module from network.

## System Errors

### USB Errors

Code	Type	Description	Problem	Cause	Solution
EAUX	Advisory	USB Busy	USB drive is inserted, download is in progress.	Indicates USB port is uploading or downloading data.	Wait for USB Idle.
EBUX	Record	USB Drive Removed	USB drive was removed while downloading or uploading.	Downloading/uploading data on USB was interrupted by the USB device being removed.	Replace the USB device and begin process again.
EQU0	Advisory	USB Idle	USB download completed, drive may be removed.	Data transfer is completed to the USB device.	Remove USB device from ADM.
EQU1	Record	USB Sys. Settings Downloaded	Settings were downloaded to USB drive.	User installed USB device in ADM USB port.	n/a
EQU2	Record	USB Sys. Settings Uploaded	Settings were uploaded from USB drive.	User installed USB device in ADM USB port.	n/a
EQU3	Record	USB Custom Lang. Downloaded	Custom language was downloaded to USB drive.	User installed USB device in ADM USB port.	n/a
EQU4	Record	USB Custom Lang. Uploaded	Custom language was uploaded from USB drive.	User installed USB device in ADM USB port.	n/a
EQU5	Record	USB Logs Downloaded	Data logs were downloaded to USB drive.	User installed USB device in ADM USB port.	n/a
EVUX	Advisory	USB Disabled	USB drive has been inserted, downloading is disabled.	Configuration of system is blocking data transfer.	Change configuration to enable USB download function.
MMUX	Advisory	Maint. USB Logs Full	USB memory is more than 90% full.	Configuration parameter on system is enabled to generate this advisory.	Complete download to ensure no data is lost.
WSUX	Advisory	USB Config. Err.	USB configuration file does not match expected; checked on startup.	A software update was not completed successfully.	Reinstall software.
WXUD	Advisory	USB Download Err.	An error occurred while downloading to the USB drive.	User installed incompatible USB device in ADM USB port.	Repeat process with compatible USB device.
WXUU	Advisory	USB Upload Err.	An error occurred while uploading from the USB drive.	User installed incompatible USB device in ADM USB port.	Repeat process with compatible USB device.



## Miscellaneous Errors

**NOTE:** In some error codes listed below, a # symbol is shown as the last digit. This symbol represents the applicable component number, which can vary. The unit's display will show the applicable number as the last digit in the code. For example, the B9D# code listed in this table will be displayed as B9D1 if the affected component is pump 1, B9D2 for pump 2, and so on.

Code	Type	Description	Problem	Cause	Solution
B9A0	Advisory	Volume Rollover A Current	Batch counter for material A rolled over.	The totalizer has reached maximum capable value and started over at zero.	n/a
B9AX	Advisory	Volume Rollover A Lifetime	Grand total counter for material A rolled over.	The totalizer has reached maximum capable value and started over at zero.	n/a
B9B0	Advisory	Volume Rollover B Current	Batch counter for material B rolled over.	The totalizer has reached maximum capable value and started over at zero.	n/a
B9BX	Advisory	Volume Rollover B Lifetime	Grand total counter for material B rolled over.	The totalizer has reached maximum capable value and started over at zero.	n/a
B9D#	Advisory	Volume Rollover Pump #	Grand total counter for pump # rolled over.	The totalizer has reached maximum capable value and started over at zero.	n/a
B9S0	Advisory	Volume Rollover Solvent Current	Batch counter for solvent rolled over.	The totalizer has reached maximum capable value and started over at zero.	n/a
B9SX	Advisory	Volume Rollover Solvent Lifetime	Grand total counter for solvent rolled over.	The totalizer has reached maximum capable value and started over at zero.	n/a
WX00	Alarm	Software Errors	An unexpected software error has occurred.		Call Graco technical support.

## System Errors

### Calibration Errors

**NOTE:** In some error codes listed below, a # symbol is shown as the last digit. This symbol represents the applicable component number, which can vary. The unit's display will show the applicable number as the last digit in the code. For example, the ENT# code listed in this table will be displayed as ENT1 if the affected component is pump 1, ENT2 for pump 2, and so on.

Code	Type	Name	Description
END#	Record	Calibration Pump #	A calibration test was run on the pump.
ENS0	Record	Calibration Solvent Meter	A calibration test was run on the solvent meter.
ENT#	Record	Calibration Stall Test Pump #	A stall test was completed successfully on pump #.

## Electrostatic Error Code Tables

### Electrostatic Controller Failure Errors

Code	ES Code	Type	Name	Description	Solution
H20X	H20	Alarm	ES Controller Error	Onboard generated voltage is out of tolerance.	<ul style="list-style-type: none"> <li>• Verify all connections inside of controller are properly made.</li> <li>• Verify power source is good.</li> <li>• Replace 24VDC board or power board if necessary.</li> </ul>
H21X	H21	Alarm	ES Controller Error	24V supply has dropped below 21V. Remark: No error code is displayed.	
H24X	H24	Alarm	ES Controller Error	Magic number doesn't match the expected value.	<ul style="list-style-type: none"> <li>• Verify all connections inside of controller are properly made.</li> <li>• Replace main board if necessary</li> </ul>
H25X	H25	Alarm	ES Controller Error	Writing to EEPROM takes longer than 10 minutes.	
H26X	H26	Alarm	ES Controller Error	Data to be written at power off hasn't been properly saved to the EEPROM.	<ul style="list-style-type: none"> <li>• Do not turn off controller so quickly after making setting changes.</li> <li>• Verify all connections inside of controller are properly made.</li> <li>• Replace main board if necessary.</li> </ul>
H27X	H27	Alarm	ES Controller Error	Verification of the data written to the EEPROM failed.	

System Errors

Code	ES Code	Type	Name	Description	Solution	
H80X	H80	Alarm	ES Controller Error	No response or timeout to a request. Error report on command execution. Response data mismatch.	<ul style="list-style-type: none"> <li>• Verify all connections inside of controller are properly made.</li> <li>• Verify software version and upgrade if needed.</li> <li>• Replace main board if necessary.</li> </ul>	
H81X	H81	Alarm	ES Controller Error	The self-test performed by the safety controller detected an error.		
H82X	H82	Alarm	ES Controller Error	Heartbeat message timeout.		
H83X	H83	Alarm	ES Controller Error	24 VDC interlock removed while electrostatics is in operation.		
H84X	H84	Alarm	ES Controller Error	The firmware requires an update.		
H85X	H85	Alarm	ES Controller Error	Attempt to turn on the electrostatics while the applicator isn't in the safe position.		
H86X	H86	Alarm	ES Controller Error	Attempt to turn on the electrostatics without valid arc detection parameters set.		
H87X	H87	Alarm	ES Controller Error	Too many message transmission requests at the same time.		
H88X	H88	Alarm	ES Controller Error	An attempt is made to turn on the electrostatics when the digital output type is not configured.		
H90X	H90	Advisory	Applicator Controller Communication Error	Internal controller failure.		
H92X	H92	Advisory	Applicator Controller Not Alive	Internal controller failure.		
H94X	H94		ES Controller Error	The firmware requires an update.		Verify the software version and update.
H95X	H95		ES Controller Error	Mismatch between the type of cascade and the type of applicator		Contact Graco technical assistance.

Code	ES Code	Type	Name	Description	Solution
902X	H902	Deviation	Out of Memory	Memory allocation failed.	<ul style="list-style-type: none"> <li>• Verify that all connections inside of the controller are properly made.</li> <li>• Restart controller.</li> <li>• Verify software version and upgrade if needed.</li> <li>• Replace main board if necessary.</li> </ul>
903X	H903	Deviation	Watchdog timeout	Watchdog wasn't serviced when necessary.	
904X	H904	Deviation	Stack Overflow	A stack overflow has been detected.	
905X	H905	Deviation	Hard Fault Error	The CPU has detected a hard fault.	
999X	H999	Deviation	Other Fatal Error	Unspecified fatal error.	

## System Errors

### Electrostatic Errors

Code	ES Code	Type	Name	Description	Solution
H11X	H11 Reason Code: 0001	Alarm	Applicator Failure	The controller does not detect a current from the applicator, or detects a current that is too low.	<ul style="list-style-type: none"> <li>• Verify applicator power cable connection and test continuity on the power cable.</li> <li>• Replace applicator power cable or applicator power supply if needed.</li> </ul>
	H11 Reason Code: 0002	Alarm	Applicator Failure	The controller detects a current that is too high.	
	H11 Reason Code: 0003	Alarm	Applicator Failure	The controller detects a high applicator temperature.	<ul style="list-style-type: none"> <li>• Verify the applicator power cable connection, perform power cable continuity, and replace the cable if needed.</li> <li>• Replace the applicator power cable or applicator power supply if needed.</li> </ul>
	H11 Reason Code: 0004	Alarm	Applicator Failure	The controller detects a high applicator input voltage.	Replace applicator power supply.
H12X	H12	Alarm	Spraying current offset high	The controller has detected a high off-state current. This error can occur during normal operation in waterborne systems during discharge or when multiple applicators are connected to the same fluid supply.	<ul style="list-style-type: none"> <li>• Verify the applicator power cable connection, perform power cable continuity, and replace the cable if needed.</li> <li>• Replace the applicator power cable if needed.</li> <li>• Verify all connections inside the controller</li> <li>• Replace the main board if needed.</li> <li>• Verify system grounding.</li> </ul>
H13X	H13	Alarm	ES DC Overvoltage	Applicator voltage is too high.	<ul style="list-style-type: none"> <li>• Verify applicator power cable connection and test continuity on the power cable.</li> <li>• Replace applicator power cable or applicator power supply if needed.</li> </ul>
H91X	H91	Advisory	Cascade Communication Error	Communication failure with cascade.	

### Arc Detection Errors

Code	ES Code	Type	Name	Description	Solution
H15X	H15	Alarm	ES Arc Static Limit	The static arc detection threshold is exceeded. A grounded object came too close to the applicator.	<ul style="list-style-type: none"> <li>• Verify closest distance to parts.</li> <li>• Verify paint conductivity.</li> <li>• Verify spraying parameters associated with static arc detection, see Run Screen 2 (Arc Limits) in ES Controller Manual.</li> </ul>
H16X	H16	Alarm	ES Arc Dynamic Limit	The dynamic arc detection threshold is exceeded. A grounded object approached the applicator at too high of a speed.	<ul style="list-style-type: none"> <li>• Verify fastest approach to parts.</li> <li>• Verify paint conductivity.</li> <li>• Verify spraying parameters associated with dynamic arc detection, see Run Screen 2 (Arc Limits) in ES Controller Manual.</li> </ul>
H17X	H17	Alarm	ES Arc Both Limit	A grounded object came too close to the applicator at too high of a speed.	<ul style="list-style-type: none"> <li>• Verify closest distances to parts.</li> <li>• Verify fastest approach to parts.</li> </ul>
H18X	H18	Alarm	ES Arc Unspecified	Arc detection has been triggered due to an unspecified reason.	<ul style="list-style-type: none"> <li>• Verify paint conductivity.</li> </ul>
H19X	H19	Alarm	ES Arc DC Link Voltage	Communication between the power supply and the controller has failed.	<ul style="list-style-type: none"> <li>• Verify spraying parameters associated with arc detection, see Run Screen 2 (Arc Limits) in ES Controller Manual</li> </ul>

*System Errors*

**CAN Bus Errors**

<b>Code</b>	<b>ES Code</b>	<b>Type</b>	<b>Name</b>	<b>Description</b>	<b>Solution</b>
H40X	H40	Advisory	ES CAN Error	The CAN controller went to bus off state due to permanent bus error.	<ul style="list-style-type: none"> <li>• Verify that parameter P02 on Setup Screen 2 is set to CAN mode and parameter P06 on Setup Screen 6 is correct. See Electrostatic Controller manual.</li> <li>• Verify CAN cable connections.</li> <li>• Verify that CAN devices are connected and functioning.</li> <li>• Replace CAN board, if necessary.</li> </ul>
H41X	H41	Advisory		The CAN controller went to error passive state due to repeated bus errors.	
H42X	H42	Advisory		Can messages are arriving too quickly.	
H43X	H43	Advisory		Can messages arrive faster than they can be transferred to the receive queue.	
H44X	H44	Advisory		ES CAN Heartbeat	



## Air Control Error Code Tables

## Interlock Errors

Code	Type	Name	Description	Solution
EBDX	Alarm	Interlock	Interlock on speed control is active.	If the Air Controller reads the input as CLOSED, it interrupts system operation and turns off. If the input is read as OPEN, the system operates normally.
V80X	Alarm	ES Interlock System	System power interlock is not satisfied.	See Table 1 in the Pro Xpc / ProBell Electrostatic Controller manual for interlock requirements. (Refer to <a href="#">Related Manuals, page 3.</a> )
V81X	Alarm	ES Interlock 24VDC	24 VDC interlock is not satisfied.	
V82X	Advisory	ES Interlock Safe	Safe position interlock is not satisfied.	

## Electronic Shaping Air Errors

**NOTE:** Air 1 is Inner Shaping Air for Pro Xpc applicators, atomizing air for all other applicators. Air 2 is Outer Shaping Air for Pro Xpc applicators, fan air for all other applicators.

Code	Type	Name	Description	Solution
P1Y1	Alarm	Pressure Low, Atomizing Air	Actual atomizing air pressure is lower than the alarm limit for longer than the alarm time (as set on Gun Screen 2).	Verify Atomizing Air hose is not cut or split.
P1Y2	Alarm	Pressure Low, Fan Air	Actual fan air pressure is lower than the alarm limit for longer than the alarm time (as set on Gun Screen 2).	Verify Fan Air hose is not cut or split.
P2Y1	Deviation	Pressure Low, Atomizing Air	Actual atomizing air pressure is lower than the deviation limit for longer than the deviation time (as set on Gun Screen 2).	Verify Atomizing Air hose is not cut or split.
P2Y2	Deviation	Pressure Low, Fan Air	Actual fan air pressure is lower than the deviation limit for longer than the deviation time (as set on Gun Screen 2).	Verify Fan Air hose is not cut or split.
P3Y1	Deviation	Pressure High, Atomizing Air	Actual atomizing air pressure is higher than the deviation limit for longer than the deviation time (as set on Gun Screen 2).	<ul style="list-style-type: none"> <li>• Calibrate the voltage to pressure regulator (V2P). See <a href="#">Calibration Screens, page 126.</a></li> <li>• Verify the air tubing is connected properly.</li> <li>• Verify cable connections.</li> <li>• Replace the voltage to pressure regulator (V2P).</li> </ul>
P3Y2	Deviation	Pressure High, Fan Air	Actual fan air pressure is higher than the deviation limit for longer than the deviation time (as set on Gun Screen 2).	
P4Y1	Alarm	Pressure High, Atomizing Air	Actual atomizing air pressure is higher than the alarm limit for longer than the alarm time (as set on Gun Screen 2).	
P4Y2	Alarm	Pressure High, Fan Air	Actual fan air pressure is higher than the alarm limit for longer than the alarm time (as set on Gun Screen 2).	

System Errors

Code	Type	Name	Description	Solution
P5Y1	Alarm	Calibration Error, Atomizing Air	The returned value of the calibration on Atomizing Air is out of range.	<ul style="list-style-type: none"> <li>Relieve inlet air pressure on air control enclosure. Retry Calibration</li> <li>Verify cable connection between voltage to pressure regulator and connectors on air control on FCM (connector 6 for Atomizing Air, connector 7 for Fan Air). Retry calibration.</li> <li>Replace cable 17K902.</li> <li>Replace voltage to pressure regulator.</li> </ul>
P5Y2	Alarm	Calibration Error, Fan Air	The returned value of the calibration on Fan Air is out of range.	
P6Y1	Alarm	Atomizing Air sensor disconnected	The returned value of the pressure sensor for Atomizing Air is zero.	<ul style="list-style-type: none"> <li>Replace cable 17K902.</li> <li>Replace voltage to pressure regulator.</li> </ul>
P6Y2	Alarm	Fan Air sensor disconnected	The returned value of the pressure sensor for Fan Air is zero.	

Solenoid Errors

Code	Type	Name	Description	Solution	Air Control Connections (See Integrated Air Control Instructions manual for references)
WJD1	Alarm	Turbine Air Solenoid Removed	System does not detect the Turbine Air solenoid on the Speed Control.	Verify wiring on terminals 1 and 2 in the Speed Control.	
WJD2	Alarm	Brake Air Solenoid Removed	System does not detect the Brake Air solenoid on the Speed Control.	Verify wiring on terminals 3 and 4 in the Speed Control.	
WJP1	Alarm	Air 1 Solenoid Removed	System does not detect the Air 1 solenoid.		Verify cable connection to Atomizing Air Solenoid (N) and FCM Port 1 (AA), splitter #1.
WJP2	Alarm	Air 2 Solenoid Removed	System does not detect the Air 2 solenoid.		Verify cable connection to Fan Air Solenoid (M) and FCM Port 1 (AA), splitter #2.
WJP3	Alarm	Paint Trigger Removed	System does not detect the Gun Trigger solenoid.		Verify cable connection to Paint Trigger Solenoid (D) and FCM Port 2 (AB), splitter #1.

Code	Type	Name	Description	Solution	Air Control Connections (See Integrated Air Control Instructions manual for references)
WJP4	Alarm	Auxiliary 1 Solenoid Removed	System does not detect the Auxiliary 1 solenoid.		Verify cable connection to Paint Trigger Solenoid (E) and FCM Port 2 (AB), splitter #2.
WJP5	Alarm	Auxiliary 2 Solenoid Removed	System does not detect the Auxiliary 2 solenoid.		Verify cable connection to Paint Trigger Solenoid (F) and FCM Port 2 (AB), splitter #3.
WJP6	Alarm	Auxiliary 3 Solenoid Removed	System does not detect the Auxiliary 3 solenoid.		Verify cable connection to Paint Trigger Solenoid (G) and FCM Port 2 (AB), splitter #4.

**Speed Control Error Code Tables**

Code	Type	Name	Description	Solution
K1YX	Alarm	Speed Low Alarm	Actual turbine speed is lower than the alarm limit for longer than the alarm time (as set on Gun Screen 4).	<ul style="list-style-type: none"> <li>• Verify inlet air pressure and flow is sufficient. (Pressure greater than 70 psi)</li> </ul>
K2YX	Deviation	Speed Low Deviation	Actual turbine speed is lower than the deviation limit for longer than the deviation time (as set on Gun Screen 4).	<ul style="list-style-type: none"> <li>• Check turbine air hose on Speed Controller is not pinched.</li> </ul>
K3YX	Deviation	Speed High Deviation	Actual turbine speed is higher than the deviation limit for longer than the deviation time (as set on Gun Screen 4).	<ul style="list-style-type: none"> <li>• High fluid flow while turning paint trigger off</li> <li>• Verify that the voltage to pressure regulator in the Speed Controller is working properly.</li> </ul>
K4YX	Alarm	Speed High Alarm	Actual turbine speed is higher than the alarm limit for longer than the alarm time (as set on Gun Screen 4) or speed has exceeded 65 kRPM.	<ul style="list-style-type: none"> <li>• Verify brake solenoid is operating properly.</li> </ul>
K5YX	Alarm	Speed Controller Calibration	When calibrating turbine voltage to pressure feedback voltage, the control module detects a fault in the voltage.	<ul style="list-style-type: none"> <li>• Relieve the inlet air pressure on speed control enclosure. Retry Calibration.</li> <li>• Verify cable connection between voltage to pressure regulator and connector 6 on speed control on FCM. Retry calibration.</li> <li>• Replace cable 17K902.</li> <li>• Replace voltage to pressure regulator.</li> </ul>
K6YX	Alarm	Speed Sensor Failure	System cannot detect rotational speed.	<ul style="list-style-type: none"> <li>• Repair or replace the fiber optic cable.</li> <li>• Reinstall and tighten the fiber optic connector.</li> <li>• Inspect and clean the turbine wheel.</li> </ul>
K7YX	Alarm	Speed Control Pressure Unknown	The system cannot determine the pressure switch state.	Verify wiring on the pressure switch.
K8YX	Alarm	Speed Control Feedback	Turbine speed feedback was not detected	<ul style="list-style-type: none"> <li>• Verify Fiber Optic connection on speed control box.</li> <li>• Verify Fiber Optic connection on applicator.</li> <li>• Confirm ends of the fiber optic cable are in good shape.</li> </ul>
K9YX	Alarm	Speed Control Bearing Pressure Low	Turbine bearing return pressure is lower than 70 psi (4.82 bar, .482 MPa)	<ul style="list-style-type: none"> <li>• Verify Fiber Optic connection on speed control box.</li> <li>• Verify Fiber Optic connection on applicator.</li> <li>• Confirm ends of the fiber optic cable are in good shape.</li> </ul>

## Maintenance Error Code Tables

### Maintenance Errors

**NOTE:** In some error codes listed below, a # symbol is shown as the last digit. This symbol represents the applicable component number, which can vary. For example, the MAD# code listed in this table will be displayed as MAD1 if the affected component is pump 1, MAD2 for pump 2, and so on.

Because some components are assigned a 2–digit number, the last digit of the code is displayed as an alphanumeric character. The second table below correlates the alphanumeric digit to its component number. For example, code MEDZ represents outlet valve 30.

Code	Type	Name	Description
MAD#	Advisory	Maint. Outlet Pump #	Maintenance is due on pump.
MAT#	Advisory	Maint. Stall Test Pump #	Maintenance stall test is due on pump.
MDD1	Advisory	Maintenance Due Paint Valve	Valve trigger count has exceeded maintenance set point.
MDD2	Advisory	Maintenance Due Atomizing Air Valve.	
MDD3	Advisory	Maintenance Due Fan Air Valve.	
MDD4	Advisory	Maintenance Due Auxiliary 1 Valve.	
MDD5	Advisory	Maintenance Due Auxiliary 2 Valve.	
MDD6	Advisory	Maintenance Due Auxiliary 3 Valve.	
MDD7	Advisory	Maintenance Due Turbine Air Valve.	
MDD8	Advisory	Maintenance Due Brake Air Valve.	
MEB#	Advisory	Maint. Valve Catalyst (B) #	Maintenance is due on catalyst valve.
MED#	Advisory	Maint. Valve Outlet #	Maintenance is due on outlet valve.
MEF#	Advisory	Maint. Valve Inlet #	Maintenance is due on inlet valve.
MEG#	Advisory	Maint. Valve Gun #	Maintenance is due on applicator valve.
MES#	Advisory	Maint. Valve Solvent #	Maintenance is due on solvent valve.
MFF#	Advisory	Maint. Meter Flow #	Maintenance is due on flow meter.
MFS0	Advisory	Maint. Meter Solvent	Maintenance stall test is due on solvent meter.
MGH0	Advisory	Maint. Filter Fluid	Maintenance is due on fluid filter.
MGP0	Advisory	Maint. Filter Air	Maintenance is due on air filter.

*System Errors*

**Alphanumeric Last Digits**

Alphanumeric Digit	Component Number
1	1
2	2
3	3
4	4
5	5
6	6
7	7
8	8
9	9
A	10
B	11
C	12
D	13
E	14
F	15

Alphanumeric Digit	Component Number
G	16
H	17
J	18
K	19
L	20
M	21
N	22
P	23
R	24
T	25
U	26
V	27
W	28
Y	29
Z	30

# Maintenance

## Preventive Maintenance Schedule

The operating conditions of your particular system determine how often maintenance is required. Establish a preventive maintenance schedule by recording when and what kind of maintenance is needed, and then determine a regular schedule for checking your system.

## Flushing

- Flush before changing fluids, before fluid can dry in the equipment, at the end of the day, before storing, and before repairing equipment.
- Flush at the lowest pressure possible. Check connectors for leaks and tighten as necessary.
- Flush with a fluid that is compatible with the fluid being dispensed and the equipment wetted parts.

## Cleaning the ADM

Use any alcohol-based household cleaner, such as glass cleaner, to clean the ADM.

# Appendix A: Integration with Allen Bradley PLC

This appendix outlines how to integrate a ProMix PD2K with an Allen Bradley Studio 5000 Programmable Logic Controller (PLC).

To integrate, the ProMix PD2K must have the Ethernet/IP protocol for PLC CGM (Graco Part number CGMEPO) installed prior to performing this procedure.

In the PLC software, perform the following steps:

1. Add the new Ethernet module.

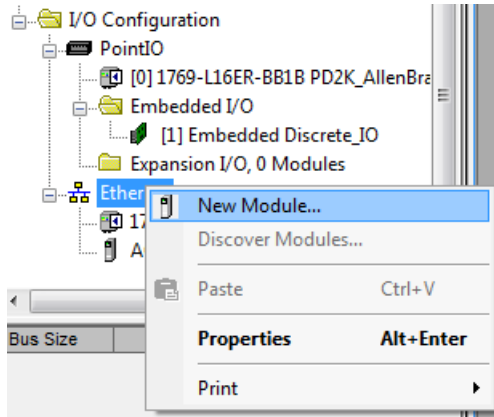

2. The **Select Module Type** screen opens.

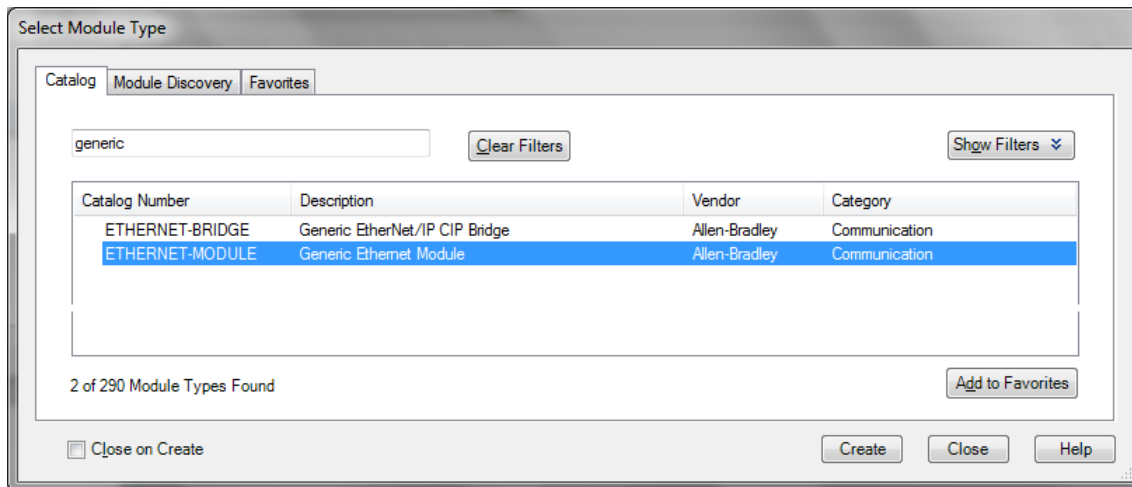

- a. In the search field, type "generic" .
- b. Select ETHERNET-MODULE Generic Ethernet Module.  
**NOTE:** Do not select the Close on Create checkbox.
- c. Click the Create button.



3. The **New Module** screen opens.

Module Properties Report: Local (ETHERNET-MODULE 1.1)

General | Connection | Module Info

Type: ETHERNET-MODULE Generic Ethernet Module  
 Vendor: Allen-Bradley  
 Parent: Local  
 Name: PD2K\_Integrated  
 Description:  
 Comm Format: Data - DINT  
 Address / Host Name  
 IP Address: 192 . 168 . 1 . 13  
 Host Name:  
 Connection Parameters  
 Input: Assembly Instance: 100 Size: 39 (32-bit)  
 Output: Assembly Instance: 150 Size: 25 (32-bit)  
 Configuration: Assembly Instance: 1 Size: 0 (8-bit)  
 Status Input:  
 Status Output:  
 Status: Offline  
 OK Cancel Apply Help

Configure the module by defining the fields as follows:

**NOTE:** The Open Module Properties checkbox must remain selected so that the configuration can be completed after completing this screen.

- a. Name (required): Enter a name for the module (select a name that will have meaning for you when viewed on the Ethernet directory shown by the figure in step 1).
- b. Description (optional): Use any description desired.
- c. IP Address (required): Enter the static IP address of the Graco EtherNet/IP CGM installed in the ProMix PD2K.
- d. Input: Assembly Instance (required): Enter “100”, which is a device-specific parameter for the Graco EtherNet/IP CGM.
- e. Input: Size (required): Enter “39”, which is the number of 32-bit registers that are allocated for input variables in the Graco EtherNet/IP CGM.
- f. Output: Assembly Instance (required): Enter “150”, which is the device-specific parameter for the Graco EtherNet/IP CGM.
- g. Output: Size (required): Enter “25”, which is the number of 32-bit registers that are allocated for output variables in the Graco EtherNet/IP CGM.
- h. Configuration: Assembly Instance (required): Enter “1”.
- i. Configuration: Size (required): Enter “0”.
- j. Click the OK button. The **Module Properties Report** window will be displayed.

4. On the Connection tab:

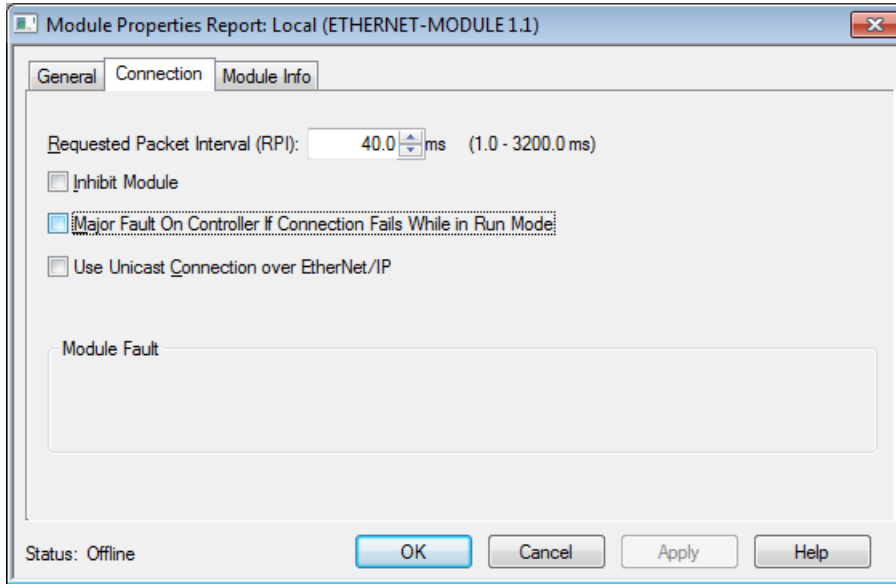

**NOTE:** An asterisk appears after the tab heading if unsaved changes are present. Click the Apply button to save changes without exiting this screen.

- a. Enter a Requested Packet Interval (RPI) value.  
**NOTE:** Graco recommends a value of 30 ms or greater.
- b. If desired, select the available checkboxes.
- c. Click the OK button to save all changes and exit this screen.

**Table 9 Potential Configuration Problems**

Error	Description
Connection Request Error — Invalid Input Application Path	This error, which also triggers an I/O Fault on the PLC, is caused by an invalid number being entered for the <b>Input: Assembly Instance</b> parameter. The correct value for this parameter is "100".
Connection Request Error — Invalid Output Application Path	This error, which also triggers an I/O Fault on the PLC, is caused by an invalid number being entered for the <b>Output: Assembly Instance</b> parameter. The correct value for this parameter is "150".
Connection Request Error — Invalid Input Size	This error, which also triggers an I/O Fault on the PLC, is caused by an invalid number being entered for the <b>Input: Size</b> parameter. The correct value for this parameter is "39".
Connection Request Error — Invalid Output Size	This error, which also triggers an I/O Fault on the PLC, is caused by an invalid number being entered for the <b>Output: Size</b> parameter. The correct value for this parameter is "25".
Module Configuration Rejected — Format Error	This error, which also triggers an I/O Fault on the PLC, is caused by an invalid number being entered for the <b>Configuration: Size</b> parameter. Because there are no configuration registers associated with the module, the correct value for this parameter is "0".

# Appendix B: Multiple Guns

A ProMix PD2K Automatic system normally operates with a single remote mix manifold and applicator (see Fig 69), but may be configured to used multiple (up to three maximum) remote mix manifolds and applicators (see Fig 70). Having multiple applicators

has the advantage of very fast color changes; the system could have a recipe loaded in each applicator and could then switch between them almost instantly. The PD2K will also track potlife time for multiple mixed recipes.

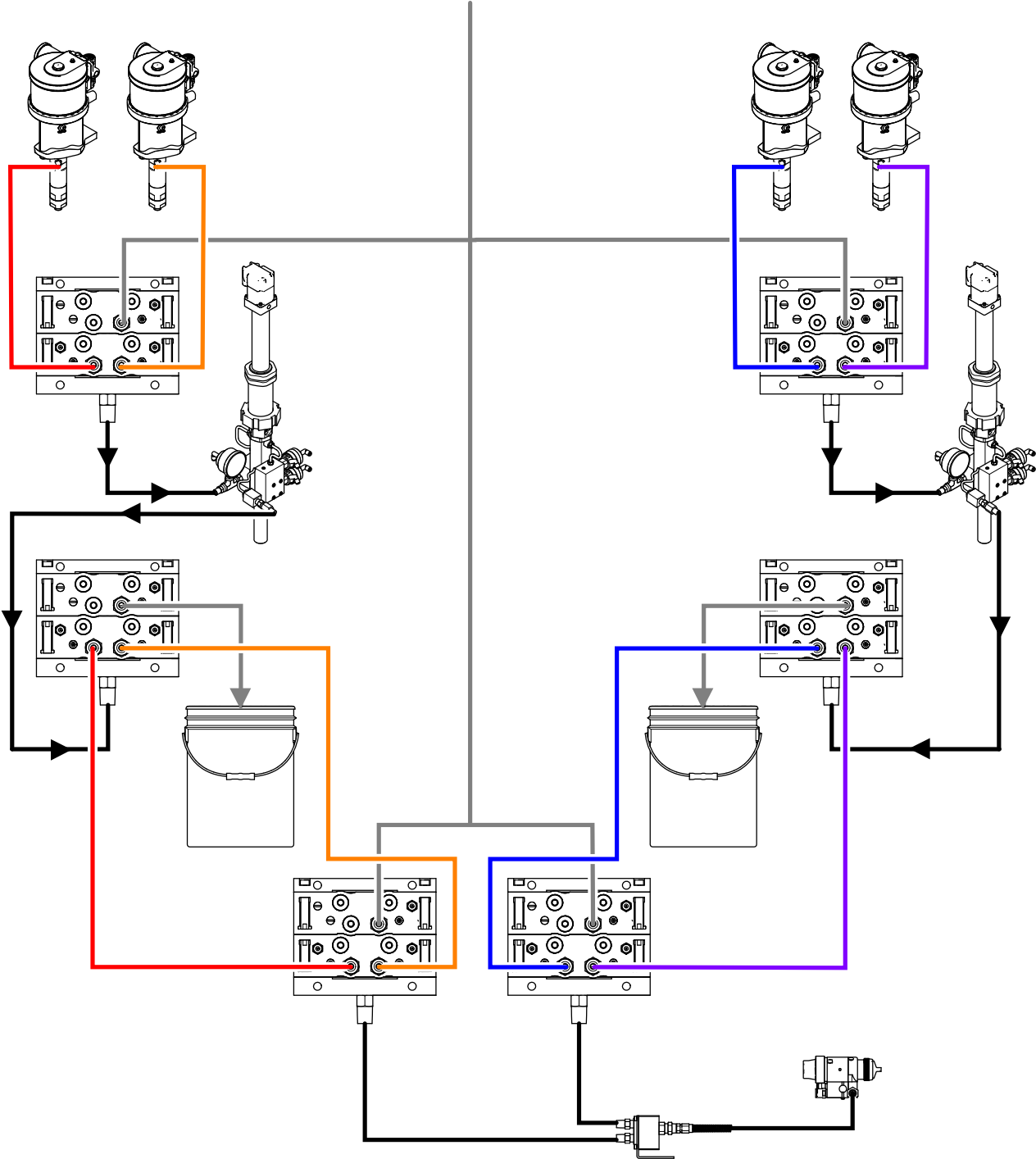

Figure 103 Fluid lines for a typical PD2K Automatic system.

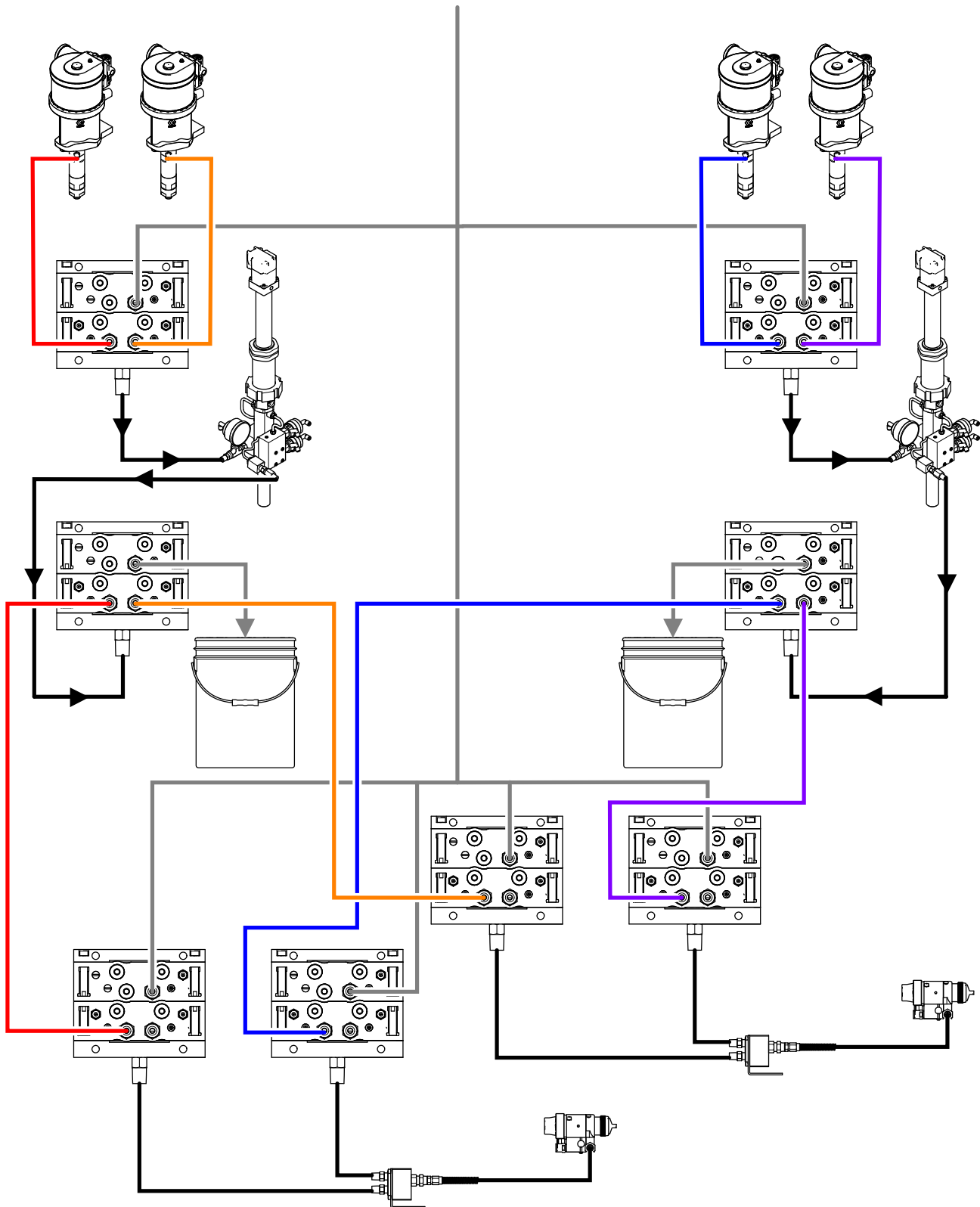

Figure 104 Fluid lines for a PD2K Automatic system with multiple applicators.

The Multiple Guns operation mode may be enabled on System Screen 3 by checking the box and then subsequently entering the number of applicators for the system in the **Number** field.

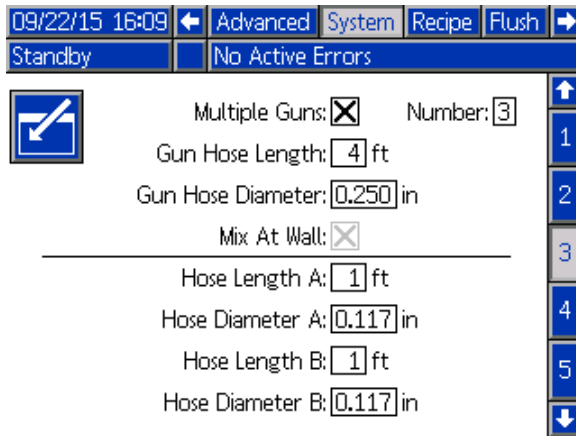

Figure 105 System Screen 3 Multiple Guns

Each color in the system must be assigned to a single applicator. Assignment of the color to an applicator is done on the Pump Screen 4 by entering the applicator number next to the color number.

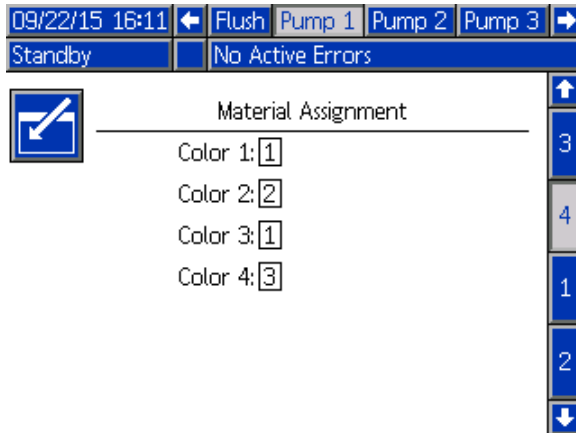

Figure 106 Pump Screen 4 Color

Catalysts may be assigned to a single applicator, shared among multiple applicators (common), or a mix of both. Only one catalyst per pump may be configured as Common, and because each assignment requires a remote valve, the total number (including each common assignment) cannot exceed four. To configure a catalyst as common to multiple applicators, check the **Common** box and select all appropriate applicators.

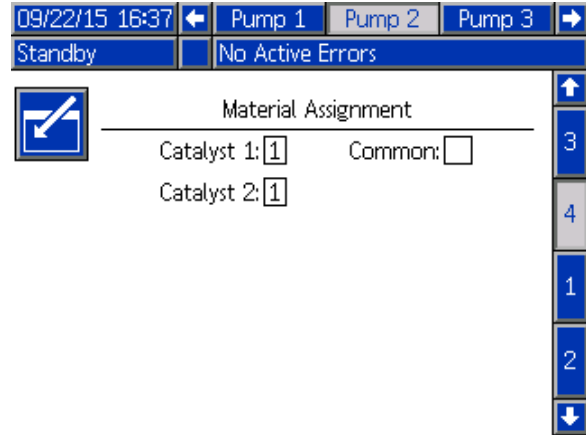

Figure 107 Pump Screen 4 Catalyst

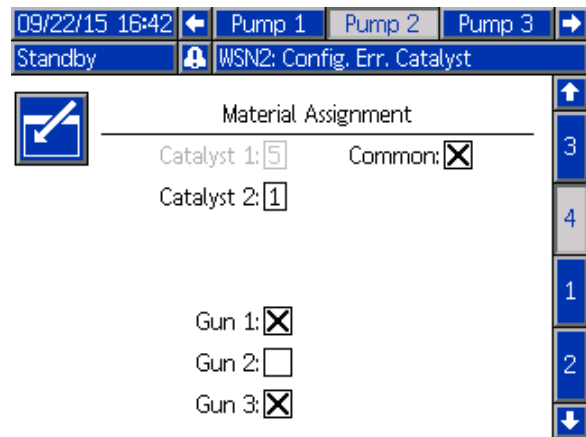

Figure 108 Pump Screen 4 Catalyst Common

Recipes can only be set up to use a color and catalyst that are assigned to the same applicator. If the color and catalyst applicator assignments do not match, the recipe will be invalidated and disabled. See [Recipe Screen, page 104](#) for more information on invalid recipes.

When common catalysts are used, the system will automatically allocate each applicator assignment to a unique remote catalyst valve (1–4), shown in the following table.

On the left, locate the row that has;

1. the number of catalyst pumps,
2. the catalyst valve map selection (see [Pump Screen 1: Pump Definitions, page 109](#)), and
3. the appropriate common catalyst configuration for your system.

Follow along the resulting row to the right to find the system's remote catalyst valve allocation.

Table 10 Remote Catalyst Valve allocation for system using Common catalyst

Cat- alyst Pumps	Valve Map Se- lection	Pump 2: Common Catalyst	Pump 4: Common Catalyst	Remote Catalyst Valve 1	Remote Catalyst Valve 2	Remote Catalyst Valve 3	Remote Catalyst Valve 4
1	Stan- dard	None	N/A	Catalyst 1	Catalyst 2	Catalyst 3	Catalyst 4
1	Stan- dard	Common to Guns 1 & 2	N/A	Catalyst 1 (Gun 1)	Catalyst 1 (Gun 2)	Catalyst 2	Catalyst 3
1	Stan- dard	Common to Guns 1 & 3	N/A	Catalyst 1 (Gun 1)	Catalyst 1 (Gun 3)	Catalyst 2	Catalyst 3
1	Stan- dard	Common to Guns 2 & 3	N/A	Catalyst 1 (Gun 2)	Catalyst 1 (Gun 3)	Catalyst 2	Catalyst 3
1	Stan- dard	Common to Guns 1-3	N/A	Catalyst 1 (Gun 1)	Catalyst 1 (Gun 2)	Catalyst1 (Gun3)	Catalyst 2
2	Stan- dard	None	-	Catalyst 1	Catalyst 2	-	-
2	Stan- dard	Common to Guns 1 & 2	-	Catalyst 1 (Gun 1)	Catalyst 1 (Gun 2)	-	-
2	Stan- dard	Common to Guns 1 & 3	-	Catalyst 1 (Gun 1)		-	-
2	Stan- dard	Common to Guns 2 & 3	-	Catalyst 1 (Gun 3)		-	-
2	Stan- dard	-	None	-	-	Catalyst 3	Catalyst 4
2	Stan- dard	-	Common to Guns 1 & 2	-	-	Catalyst 3 (Gun 1)	Catalyst 3 (Gun 2)
2	Stan- dard	-	Common to Guns 1 & 3	-	-	Catalyst 3 (Gun 1)	Catalyst 3 (Gun 3)
2	Stan- dard	-	Common to Guns 2 & 3	-	-	Catalyst 3 (Gun 2)	Catalyst 3 (Gun 3)
2	Alter- nate	None	N/A	Catalyst 1	Catalyst 2	Catalyst 3	Catalyst 4
2	Alter- nate	Common to Guns 1 & 2	N/A	Catalyst 1 (Gun 1)	Catalyst 1 (Gun 2)	Catalyst 2	Catalyst 4
2	Alter- nate	Common to Guns 1 & 3	N/A	Catalyst 1 (Gun 1)	Catalyst 1 (Gun 3)	Catalyst 2	Catalyst 4

Cat- alyst Pumps	Valve Map Se- lection	Pump 2: Common Catalyst	Pump 4: Common Catalyst	Remote Catalyst Valve 1	Remote Catalyst Valve 2	Remote Catalyst Valve 3	Remote Catalyst Valve 4
2	Alter- nate	Common to Guns 2 & 3	N/A	Catalyst 1 (Gun 2)	Catalyst 1 (Gun 3)	Catalyst 2	Catalyst 4
2	Alter- nate	Common to Guns 1-3	N/A	Catalyst 1 (Gun 1)	Catalyst 1 (Gun 2)	Catalyst 1 (Gun 3)	Catalyst 4

With Multiple Guns enabled, the system requires two additional remote solvent valves for each applicator. Because of this, the total number of colors is reduced to 26 and the valve map for the IS color change modules are configured differently. Refer to Color Change and Remote Mix Kit manual (333282) for more detail.

# Technical Specifications

Positive Displacement Proportioner	U.S.	Metric
Maximum fluid working pressure:		
AC0500 Spray Systems	Pumps sold separately; see selected pump manual maximum working pressure.	
AC1000 Air Spray Systems	300 psi	2.1 MPa, 21 bar
AC2000 Air-Assisted Spray Systems	1500 psi	10.5 MPa, 105 bar
Maximum working air pressure:	100 psi	0.7 MPa, 7.0 bar
Air supply:	85–100 psi	0.6–0.7 MPa, 6.0–7.0 bar)
Air filter inlet size:	3/8 npt(f)	
Air filtration for air logic (user-supplied):	5 micron (minimum) filtration required; clean and dry air	
Air filtration for atomizing air (user-supplied):	30 micron (minimum) filtration required; clean and dry air	
Mixing ratio range:	0.1:1 to 50:1, ±1%	
Fluids handled:	one or two component: <ul style="list-style-type: none"> <li>• solvent and waterborne paints</li> <li>• polyurethanes</li> <li>• epoxies</li> <li>• acid catalyzed varnishes</li> <li>• moisture sensitive isocyanates</li> </ul>	
Viscosity range of fluid:	20–5000 centipoise	
Fluid filtration (user-supplied):	100 mesh minimum	
Maximum fluid flow:	800 cc/minute (depending on material viscosity)	
Fluid outlet size:	1/4 npt(m)	
External power supply requirements:	90 - 250 Vac, 50/60 Hz, 7 amps maximum draw 15 amp maximum circuit breaker required 8 to 14 AWG power supply wire gauge	
Operating temperature range:	36 to 122°F	2 to 50°C
Storage temperature range:	–4 to 158°F	–20 to 70°C
Weight of base model (approximate):	195 lb	88 kg
Sound data:	Less than 75 dB(A)	
Wetted parts:	17–4PH SST, 303 SST, 304 SST, Tungsten carbide (with nickel binder), perfluoroelastomer; PTFE, PPS, UHMWPE	



<b>Integrated Air Control</b>	<b>U.S.</b>	<b>Metric</b>
Maximum Air Inlet Pressure	100 psi	7 bar
Inlet Hose	3/8 in.	9.5 mm
Outlet Hoses		
Atomizing Air	5/16 in.	8 mm
Fan Air	5/16 in.	8 mm
Paint Trigger	5/32 in.	4 mm
Auxiliary Air 1	5/32 in.	4 mm
Auxiliary Air 2	5/32 in.	4 mm
Auxiliary Air 3	5/32 in.	4 mm
Voltage	24 VDC	
Current	1 Amp	
Environmental Temperature Range	32 — 122° F	0 — 50° C
Weight	15 lbs.	6.8 kg

<b>Speed Controller</b>	<b>U.S.</b>	<b>Metric</b>
Maximum Working Pressure	100 psi	7 bar
Turbine speed, maximum operating	60,000 rpm	
Bearing air, minimum required	70 psi	0.5 MPa, 5.0 bar
Air Connection	1/2" npt	
Maximum Operating Voltage	24 VDC, 2.5A	
Power connection for part 24Z224	Straight IEC 320-C13 male connector and a North American NEMA 5-15P ISP male plug are provided.	
External Power Requirements for part 24Z224	100-240 VAC, 50/60 Hz, 2A maximum draw, 15 amp circuit breaker is recommended	
Operating Temperature Range	32° to 122° F	0° to 50° C
Storage Temperature Range	-22° to 140° F	-30° to 60° C
Weight (Model 24Z219)	34 lb.	15.4 kg.

<b>Electrostatic Controllers</b>	<b>U.S.</b>	<b>Metric</b>
Nominal Input Voltage	100-240 VAC	
Frequency	50-60 Hz	
Input Power	40 VA	
Nominal Output Voltage (to the applicator)	eff 10V	
Nominal Output Current (to the applicator)	max 1.2 A	
Protection Type	IP54	
Ambient Temperature Range	41°F - 104°F	5°C - 40°C
Dimensions		

*Technical Specifications*

<b>Electrostatic Controllers</b>	<b>U.S.</b>	<b>Metric</b>
Width	6.8 in.	173 mm
Depth	4.8 in.	122 mm
Height	7.5 in.	191 mm
Weight	approx. 4.5 lbs.	approx. 2.0 kg

# California Proposition 65

## CALIFORNIA RESIDENTS

 **WARNING:** Cancer and reproductive harm — [www.P65warnings.ca.gov](http://www.P65warnings.ca.gov).

# Graco Standard Warranty

Graco warrants all equipment referenced in this document which is manufactured by Graco and bearing its name to be free from defects in material and workmanship on the date of sale to the original purchaser for use. With the exception of any special, extended, or limited warranty published by Graco, Graco will, for a period of twelve months from the date of sale, repair or replace any part of the equipment determined by Graco to be defective. This warranty applies only when the equipment is installed, operated and maintained in accordance with Graco's written recommendations.

This warranty does not cover, and Graco shall not be liable for general wear and tear, or any malfunction, damage or wear caused by faulty installation, misapplication, abrasion, corrosion, inadequate or improper maintenance, negligence, accident, tampering, or substitution of non-Graco component parts. Nor shall Graco be liable for malfunction, damage or wear caused by the incompatibility of Graco equipment with structures, accessories, equipment or materials not supplied by Graco, or the improper design, manufacture, installation, operation or maintenance of structures, accessories, equipment or materials not supplied by Graco.

This warranty is conditioned upon the prepaid return of the equipment claimed to be defective to an authorized Graco distributor for verification of the claimed defect. If the claimed defect is verified, Graco will repair or replace free of charge any defective parts. The equipment will be returned to the original purchaser transportation prepaid. If inspection of the equipment does not disclose any defect in material or workmanship, repairs will be made at a reasonable charge, which charges may include the costs of parts, labor, and transportation.

**THIS WARRANTY IS EXCLUSIVE, AND IS IN LIEU OF ANY OTHER WARRANTIES, EXPRESS OR IMPLIED, INCLUDING BUT NOT LIMITED TO WARRANTY OF MERCHANTABILITY OR WARRANTY OF FITNESS FOR A PARTICULAR PURPOSE.**

Graco's sole obligation and buyer's sole remedy for any breach of warranty shall be as set forth above. The buyer agrees that no other remedy (including, but not limited to, incidental or consequential damages for lost profits, lost sales, injury to person or property, or any other incidental or consequential loss) shall be available. Any action for breach of warranty must be brought within two (2) years of the date of sale.

**GRACO MAKES NO WARRANTY, AND DISCLAIMS ALL IMPLIED WARRANTIES OF MERCHANTABILITY AND FITNESS FOR A PARTICULAR PURPOSE, IN CONNECTION WITH ACCESSORIES, EQUIPMENT, MATERIALS OR COMPONENTS SOLD BUT NOT MANUFACTURED BY GRACO.** These items sold, but not manufactured by Graco (such as electric motors, switches, hose, etc.), are subject to the warranty, if any, of their manufacturer. Graco will provide purchaser with reasonable assistance in making any claim for breach of these warranties.

In no event will Graco be liable for indirect, incidental, special or consequential damages resulting from Graco supplying equipment hereunder, or the furnishing, performance, or use of any products or other goods sold hereto, whether due to a breach of contract, breach of warranty, the negligence of Graco, or otherwise.

## FOR GRACO CANADA CUSTOMERS

The Parties acknowledge that they have required that the present document, as well as all documents, notices and legal proceedings entered into, given or instituted pursuant hereto or relating directly or indirectly hereto, be drawn up in English. Les parties reconnaissent avoir convenu que la rédaction du présente document sera en Anglais, ainsi que tous documents, avis et procédures judiciaires exécutés, donnés ou intentés, à la suite de ou en rapport, directement ou indirectement, avec les procédures concernées.

## Graco Information

For the latest information about Graco products, visit [www.graco.com](http://www.graco.com).

**To place an order**, contact your Graco Distributor or call to identify the nearest distributor.

**Phone:** 612-623-6921 **or Toll Free:** 1-800-328-0211 **Fax:** 612-378-3505

All written and visual data contained in this document reflects the latest product information available at the time of publication.

Graco reserves the right to make changes at any time without notice.

For patent information, see [www.graco.com/patents](http://www.graco.com/patents).

Original Instructions. This manual contains English. MM 3A4128

**Graco Headquarters:** Minneapolis

**International Offices:** Belgium, China, Japan, Korea

**GRACO INC. AND SUBSIDIARIES • P.O. BOX 1441 • MINNEAPOLIS MN 55440-1441 • USA**

**Copyright 2017, Graco Inc. All Graco manufacturing locations are registered to ISO 9001.**

[www.graco.com](http://www.graco.com)  
Revision D, November 2022