

UniXact[®] Automated Dispense Platform

3A3649D

EN

For automated, programmable, precision micro-dispensing. For professional use only.

Not approved for use in explosive atmospheres or hazardous locations.

Models:

C-300

C-500

See page 3 for additional model information and approvals.



Important Safety Instructions

Read all warnings and instructions in this manual and all related manuals. Save all instructions.

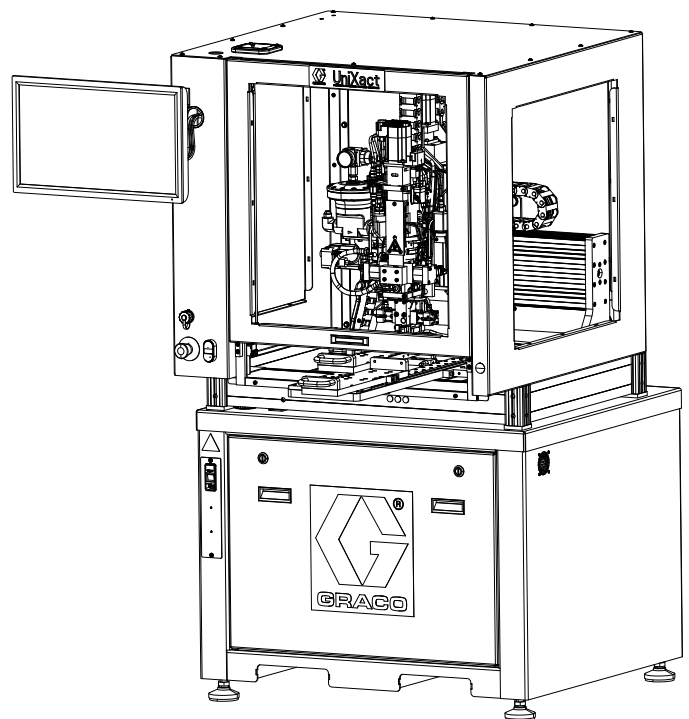

C-300 Shown



Contents

Models	3	SPC Data Screen	64
Related Manuals	3	Graphing Data	65
Warnings	4	Advanced Calibration Features	66
Two-Component Materials	7	Calibrate the Machine	66
Component Identification	8	Calibrate the Part Present Sensor Option	71
C-300	8	Calibrate the Pressure Sensor	71
C-500	9	Calibrate the Vision Option	74
Installation	10	Calibrate the Laser Option	76
Unpacking	10	Shutdown	79
Locate and Prepare the Machine	11	Pressure Relief Procedure	79
Make Connections	12	Maintenance	80
Flush Before Using Equipment	12	Lubrication Schedule for the Double Rails	80
Grounding	12	Recommended Lubricants	80
Startup	13	Double Rails Lubrication Steps	80
Start the System	13	Lubrication Schedule for the Ball Screw	81
Log In	13	Ball Screw Lubrication Steps	81
Connecting to the Motion Controller	15	Troubleshooting	82
System Functions	16	Input/Output Test Procedure	86
Setup	17	Safety Circuit Design	89
Maintenance and Load/Unload Positions	17	Error/Event Alarms	90
Maintenance Screen Functions	17	Appendix A: User Access Levels	93
Manage Inputs and Outputs	18	Appendix B: Palletize Example	94
Select Axes Coordinates	19	Appendix C: Parameters File	96
System Jogging	20	Version Number	96
System Parameter Overview	21	Records	96
Set and Verify Parameters	22	Values	96
Manage the Parameters File	22	Parameter Information	96
System Parameter Descriptions	23	Parameter Descriptions	97
Valve Parameter Descriptions	32	Appendix D: Touch Sensor Installation	98
Programming	35	Appendix E: Dispenser Integration	99
The Tool Path	35	Appendix F: Parameters Worksheets	101
Programming Commands	38	System Parameters	101
Command Properties	46	Valve Parameters	103
Invalid Commands	49	Alternate Purge Parameters	104
Using DXF Files	50	Appendix G: Support File Utility	105
Teaching Points	52	Dimensions	106
Spline Functions	55	C-300	106
Using a Teach Pendant	55	C-500	107
Teaching with Vision Enabled	57	Dispense Platform Mounting Dimensions	108
Barcode Reader	58	Technical Specifications	109
Operation	59	California Proposition 65	109
The Run Screen	59	Graco Standard Warranty	110
Select Part Programs	59		
Run Controls	60		
Single Step Mode	61		
System and Alarm Status	61		
Prepare to Run a Program	62		

Models











Part No.	Air Pressure Operating Range	Description	Approvals
C-300	80-100 psi (0.6-0.7 MPa, 5.5-7 bar)	254 mm x 277 mm automated dispense table	CE
C-500	80-100 psi (0.6-0.7 MPa, 5.5-7 bar)	500 mm x 500 mm automated dispense table	









Related Manuals

UniXact Manual	
Part	Description
3A4061	UniXact Automated Dispense Platform Maintenance and Parts Manual
PR70 Manuals	
Part	Description
312759	PR70™ and PR70v™ with Advanced Display Module Operation and Maintenance Manual
312760	PR70 and PR70v Repair and Parts Manual
PD44 Dispense Valve Manual	
Part	Description
313876	PD44™ Metering Valves and Feed Systems Operation and Maintenance Manual
3A0987	PD44 Metering Valves and Feed Systems Parts Manual
Dispensit Manuals	
Part	Description
3A0874	Dispensit® 1053-10C Operation and Maintenance Manual
313812	Dispensit 1053-10B Operation and Maintenance Manual
313566	Dispensit 1093 Operation and Maintenance Manual
332094	Dispensit 710 Instructions
PC Pump Manual	
Part	Description
3A4648	Progressive Cavity (PC) Pump Parts Manual

Warnings

The following warnings are for the setup, use, grounding, maintenance, and repair of this equipment. The exclamation point symbol alerts you to a general warning and the hazard symbols refer to procedure-specific risks. When these symbols appear in the body of this manual or on warning labels, refer back to these Warnings. Product-specific hazard symbols and warnings not covered in this section may appear throughout the body of this manual where applicable.

 <h1 style="margin: 0;">WARNING</h1>	
 	<p>MOVING PARTS HAZARD</p> <p>Moving parts can pinch, cut or amputate fingers and other body parts.</p> <ul style="list-style-type: none"> • Keep clear of moving parts. • Do not operate equipment with protective guards or covers removed. • Pressurized equipment can start without warning. Before checking, moving, or servicing equipment, follow the Pressure Relief Procedure and disconnect all power sources.
    	<p>SKIN INJECTION HAZARD</p> <p>High-pressure fluid from dispensing device, hose leaks, or ruptured components will pierce skin. This may look like just a cut, but it is a serious injury that can result in amputation. Get immediate surgical treatment.</p> <ul style="list-style-type: none"> • Do not point the dispensing device at anyone or at any part of the body. • Do not put your hand over the fluid outlet. • Do not stop or deflect leaks with your hand, body, glove, or rag. • Follow the Pressure Relief Procedure when you stop dispensing and before cleaning, checking, or servicing equipment. • Tighten all fluid connections before operating the equipment. • Check hoses and couplings daily. Replace worn or damaged parts immediately.
 	<p>ELECTRIC SHOCK HAZARD</p> <p>This equipment must be grounded. Improper grounding, setup, or usage of the system can cause electric shock.</p> <ul style="list-style-type: none"> • Turn off and disconnect power cord before servicing equipment. • Connect only to grounded electrical outlets. • Use only 3-wire extension cords. • Ensure ground prongs are intact on power and extension cords. • Do not expose to rain. Store indoors.

 <h1 style="margin: 0;">WARNING</h1>	
	<p>TOXIC FLUID OR FUMES HAZARD</p> <p>Toxic fluids or fumes can cause serious injury or death if splashed in the eyes or on skin, inhaled, or swallowed.</p> <ul style="list-style-type: none"> • Read Safety Data Sheet (SDS) to know the specific hazards of the fluids you are using. • Store hazardous fluid in approved containers, and dispose of it according to applicable guidelines.
	<p>LASER LIGHT HAZARD: AVOID DIRECT EYE CONTACT</p> <p>Eye exposure to Class II levels of laser light can cause injury, including eye (retinal) injury. To avoid direct eye exposure:</p> <ul style="list-style-type: none"> • Never look directly into a laser beam. • Never shine the laser at mirror-like surfaces that can cause specular reflections of the beam. • Do not disassemble the laser product. • Laser must be turned off when cleaning the lens, so as not to create unwanted laser refraction.
	<p>PERSONAL PROTECTIVE EQUIPMENT</p> <p>Wear appropriate protective equipment when in the work area to help prevent serious injury, including eye injury, hearing loss, inhalation of toxic fumes, and burns. Protective equipment includes but is not limited to:</p> <ul style="list-style-type: none"> • Protective eyewear, and hearing protection. • Respirators, protective clothing, and gloves as recommended by the fluid and solvent manufacturer.
   	<p>FIRE AND EXPLOSION HAZARD</p> <p>Flammable fumes, such as solvent and paint fumes, in work area can ignite or explode. Paint or solvent flowing through the equipment can cause static sparking. To help prevent fire and explosion:</p> <ul style="list-style-type: none"> • Use equipment only in well ventilated area. • Eliminate all ignition sources; such as pilot lights, cigarettes, portable electric lamps, and plastic drop cloths (potential static sparking). • Ground all equipment in the work area. See Grounding instructions. • Never spray or flush solvent at high pressure. • Keep work area free of debris, including solvent, rags and gasoline. • Do not plug or unplug power cords, or turn power or light switches on or off when flammable fumes are present. • Use only grounded hoses. • Hold gun firmly to side of grounded pail when triggering into pail. Do not use pail liners unless they are anti-static or conductive. • Stop operation immediately if static sparking occurs or you feel a shock. Do not use equipment until you identify and correct the problem. • Keep a working fire extinguisher in the work area.

WARNING



EQUIPMENT MISUSE HAZARD

Misuse can cause death or serious injury.



- Do not operate the unit when fatigued or under the influence of drugs or alcohol.
- Do not exceed the maximum working pressure or temperature rating of the lowest rated system component. See **Technical Specifications** in all equipment manuals.
- Use fluids and solvents that are compatible with equipment wetted parts. See **Technical Specifications** in all equipment manuals. Read fluid and solvent manufacturer's warnings. For complete information about your material, request Safety Data Sheet (SDS) from distributor or retailer.
- Do not leave the work area while equipment is energized or under pressure.
- Turn off all equipment and follow the **Pressure Relief Procedure** when equipment is not in use.
- Check equipment daily. Repair or replace worn or damaged parts immediately with genuine manufacturer's replacement parts only.
- Do not alter or modify equipment. Alterations or modifications may void agency approvals and create safety hazards.
- Make sure all equipment is rated and approved for the environment in which you are using it.
- Use equipment only for its intended purpose. Call your distributor for information.
- Route hoses and cables away from traffic areas, sharp edges, moving parts, and hot surfaces.
- Do not kink or over bend hoses or use hoses to pull equipment.
- Keep children and animals away from work area.
- Comply with all applicable safety regulations.

Two-Component Materials

Material Self-ignition

				
Some materials may become self-igniting if applied too thick. Read material manufacturer's warnings and material Safety Data Sheet (SDS).				

Keep Components A and B Separate

				
Cross-contamination can result in cured material in fluid lines which could cause serious injury or damage equipment. To prevent cross-contamination:				
<ul style="list-style-type: none"> • Never interchange component A and component B wetted parts. • Never use solvent on one side if it has been contaminated from the other side. 				

Changing Materials

NOTICE

Changing the material types used in your equipment requires special attention to avoid equipment damage and downtime.

- When changing materials, flush the equipment multiple times to ensure it is thoroughly clean.
- Always clean the fluid inlet strainers after flushing.
- Check with your material manufacturer for chemical compatibility.
- When changing between epoxies and urethanes or polyureas, disassemble and clean all fluid components and change hoses. Epoxies often have amines on the B (hardener) side. Polyureas often have amines on the B (resin) side.

A and B Components

NOTE: Material suppliers can vary in how they refer to plural component materials.

Be aware that orientation of the Component A and Component B hoses varies depending on the type of dispense head being used.

For additional clarification of the A and B components, refer to the manual for the dispenser you are using. If using the PD44, refer to the PD44 Metering Valves and Feed Systems Operation and Maintenance Manual, 313876.

Component Identification

C-300

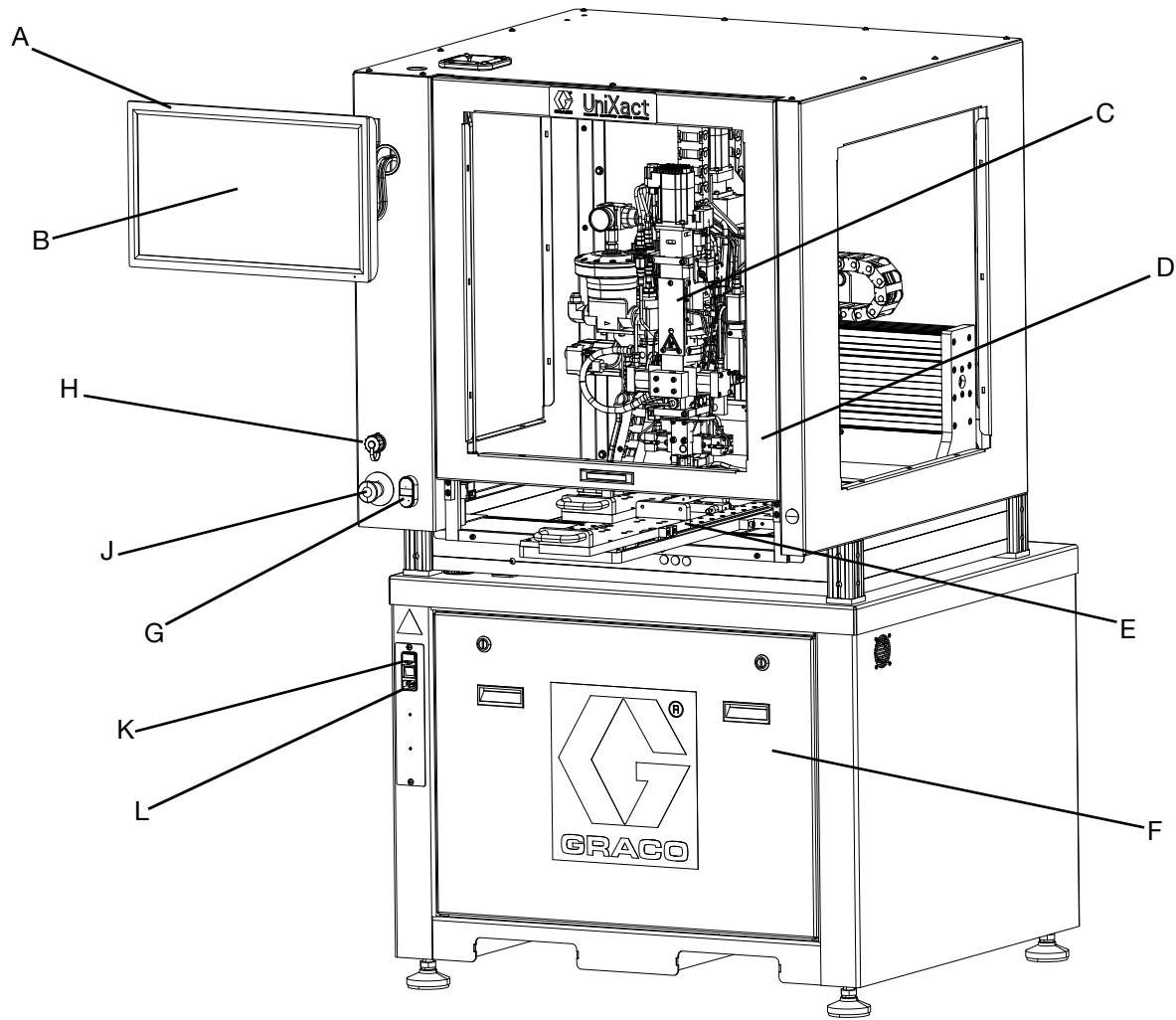
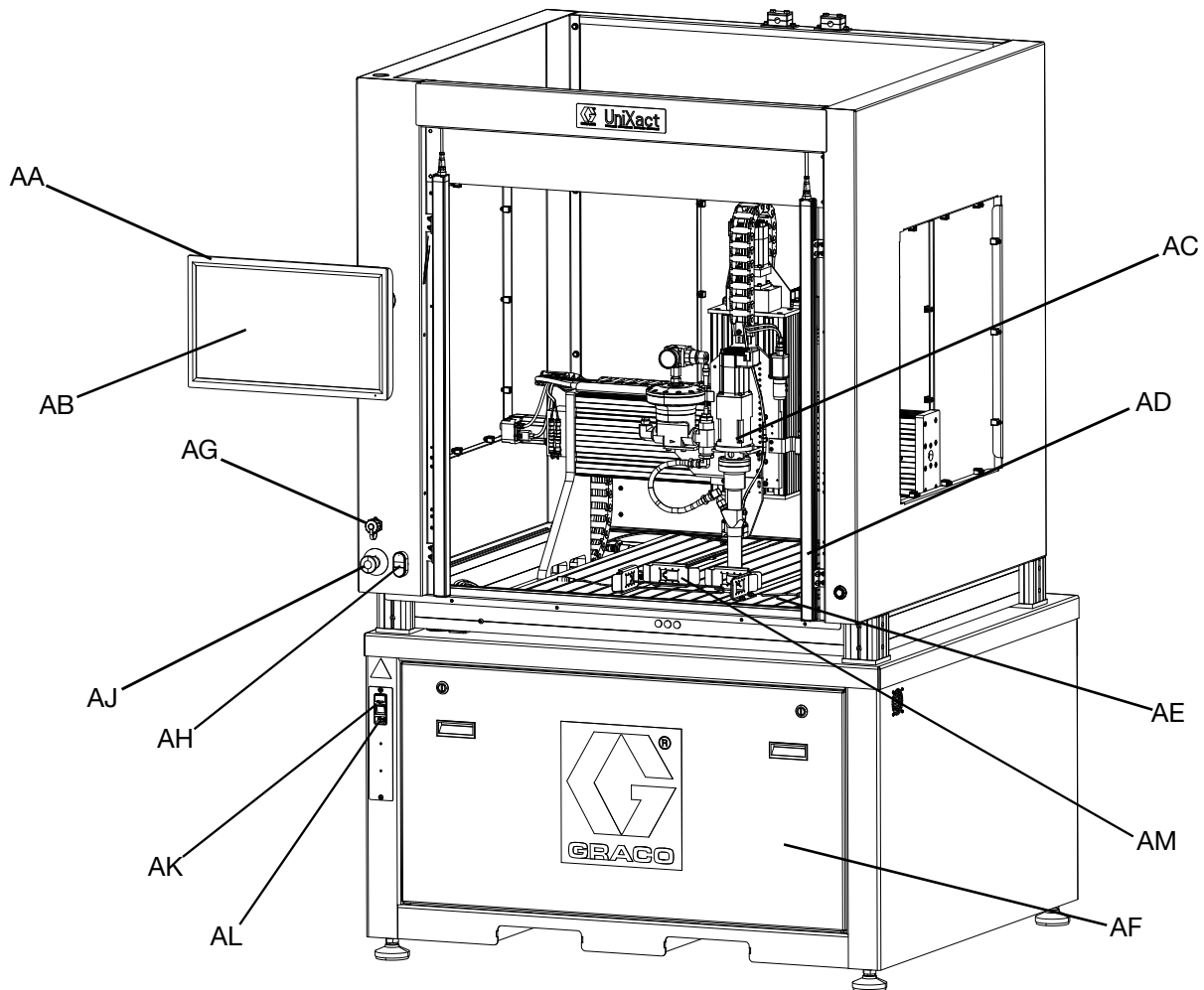

Fig. 1: C-300 Components

Key:

- A Computer Touch Screen Monitor
- B UniXact System Software Application
- C Dispenser
- D Access Door
- E Dual Y-slide
- F Access Panel to Electrical Components (including Motion Controller)
- G Control Power
- H USB Port
- J Emergency Stop
- K System Power Switch/Fused Power Inlet
- L Power Cord Connection Point

C-500**Fig. 2: C-500 Components****Key:**

- AA Computer Touch Screen Monitor
- AB Dispenser Software Application
- AC Dispenser
- AD Light Curtain
- AE Dispense Platform
- AF Access Panel to Electrical Components (including Motion Controller)
- AG USB Port
- AH Control Power
- AJ Emergency Stop
- AK System Power Switch/Fused Power Inlet
- AL Power Cord Connection Point
- AM Tray Locaters with Part in Fixture Sensors

Installation

Unpacking



The UniXact machines are shipped in large wooden crates. To avoid personal injury or damage to the machine:

- It is recommended that at least two people are present to safely remove the panels.
- Make sure the contents will not shift when removing any banding or blocking that was used to secure the components and keep them in place.

UniXact automated dispensing machine configurations vary based on table size and the options selected. For this reason, the packaging used for each machine varies as well.

The following instructions apply when unpacking UniXact systems.

1. Inspect all packaging and report any damage that may affect the condition of the equipment inside.

NOTE: All crates are equipped with drop sensors to indicate if the crate was improperly handled. Check these sensors prior to unpacking. If the sensor indicates rough handling, make note of that on the bill of lading and inspect the product for damage when unpacking.



2. Read all special instructions and warnings that are posted on the crate before attempting to open it.
3. Each machine is bolted to a pallet and then side panels are attached to each side. The lid is then fastened to the sides. Inspect the crate to see if screws or nails were used to attach the panels.
4. Disassemble the crate using a pry bar and/or electric screw driver, depending on how the crate was assembled. Remove the top first, then loosen and remove one side at a time.

5. During the unpacking process, inspect all components for damage. If you find damage, take pictures of the damaged components to show as much detail as possible and contact your Graco distributor.
6. Brace any contents that appear as if they could shift or move in an unsafe manner when packaging is removed.
7. Remove any plastic wrap and banding used to secure and protect the equipment.
8. Lift the machine from the pallet with a tow motor or fork lift.

NOTICE

The forks on the tow motor must extend completely through the machine base to ensure the machine can be removed and transported without damage.

9. Prior to starting the machine, inspect the machine closely. Additional unpacking or setup instructions in the form of tags or stickers may be attached.

NOTE: Material supply hoses shipped with the machine may contain chemicals from being wet tested at the factory. Hoses containing chemicals are capped and tagged to indicate their contents. Any other dispensing equipment included with the machines and containing chemicals is tagged and labeled. Material SDS sheets are shipped with the machine as applicable. Review all documentation before attempting to complete installation and operate the system.

Locate and Prepare the Machine

Place the UniXact machine on a flat, level surface close to necessary service requirements. The machine requires electric and air connections. (See the identification plate on the machine.) Allow sufficient clearance around the machine to gain access to the control components in the machine's base.

NOTE: Additional space may be needed for the material feed system depending on the application. Refer to the manual for the feed system you are using. See **Related Manuals** on page 3.

1. Adjust the leveler stems on the base so the table surface is level and all four levelers are contacting the floor.

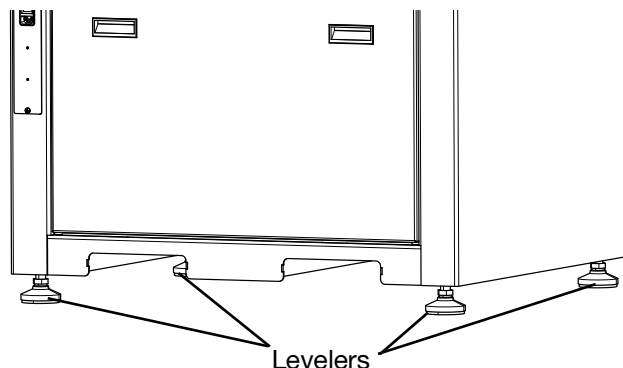

FIG. 3: Leveling the UniXact Base

2. Tighten the lock nuts on the levelers.
3. Ensure that the axes moves freely left to right and front to back along the axes as shown in **Figure 4**, and that there are no physical obstructions to movement
 - a. There is a yellow bracket with locking screws used to lock the dispenser to the gantry to prevent left-to-right motion (X axis). Remove the two screws and the bracket.
 - b. There may be banding or zip ties used to prevent the front-to-back motion (Y axis) during shipment. Remove any banding and any other packaging materials from the machine before attempting operation.

NOTE: The up and down motion (Z axis) is prevented by an electric brake that requires power to disengage. The dispenser should not move up or down until power is applied to the system and it is moved using the machine controls.

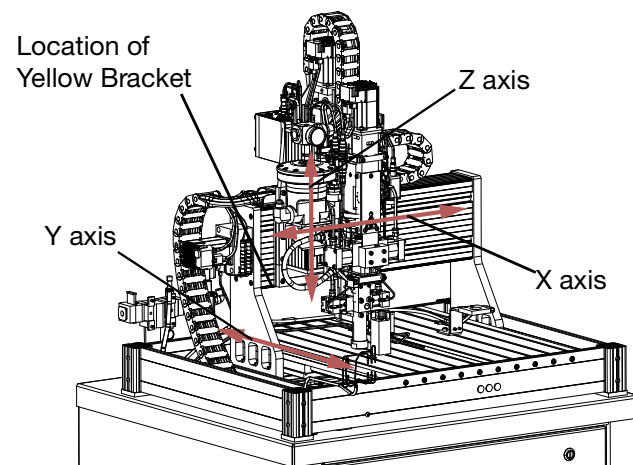

FIG. 4: Dispenser Axes Movement

4. The computer monitor is typically removed for shipment. The screws for mounting the monitor to the arm on the machine are screwed into the back of the monitor. Remove them and use them to attach the monitor to the arm. Connect the three cords hanging from the arm to the matching receptacles on the back of the monitor.

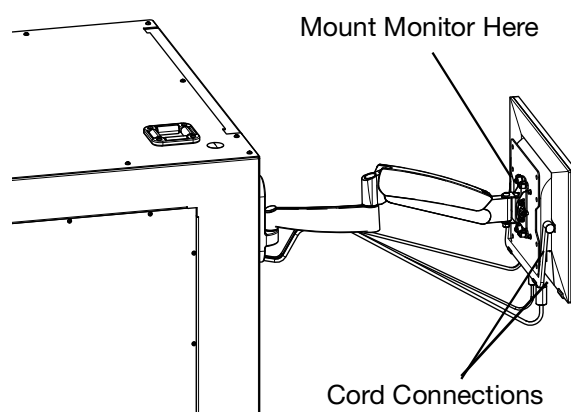

FIG. 5: Mounting the Monitor

5. Reassemble any other components that might have been removed for safe shipment. Special instructions for these components should be included.

Make Connections

Review all documentation for the feed system components before completing installation and operating the system with material

1. Review the serial number tag on the machine to determine the system power requirements.
2. Inspect all air fittings to ensure there are no loose or disconnected air tubes.
3. Apply regulated air pressure to the system.

NOTE: Pressure in excess of maximum allowable system pressure will result in the relief valve on the air inlet assembly venting to atmosphere.

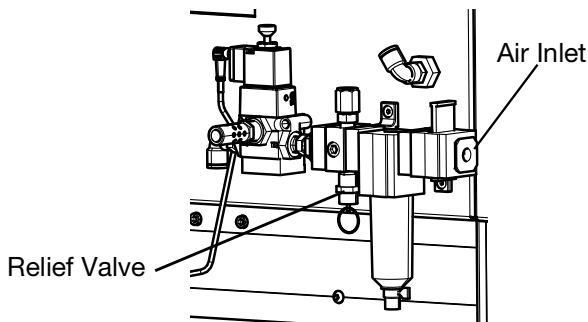

Fig. 6: Air Pressure Control Location

4. Adjust the air pressure down to within system limits to prevent the relief valve from venting.
5. Connect electrical power to the machine. Most machines are equipped with a fused IEC connector that accepts a molded cord set that plugs into a conventional wall outlet. For information about the available cord sets, see UniXact Automated Dispense Platform Maintenance - Parts manual 3A4061.
6. Install a mixer, shut off valve, and needle tip as appropriate for your application. Refer to the manual for the type of valve you are using.

NOTE: There may be custom features on your system that require additional installation and setup procedures that are not defined in this manual.

NOTE: If you are not using Y-slides, you can attach a fixture of your own design to hold parts. For help with attaching your part fixture to the dispense platform, refer to **Dispense Platform Mounting Dimensions** on page 108.

Flush Before Using Equipment

The equipment is typically tested with lightweight oil, which is left in the fluid passages to protect parts. To avoid contaminating your material with oil, flush the equipment with a compatible solvent before using the equipment. The procedure for flushing equipment depends on the type of feed system. Refer to the manual for the feed system you are using. See **Related Manuals** on page 3.

NOTE: See the tags and markings on the equipment to confirm the contents of the wetted components.

Grounding

<p>The equipment must be grounded to reduce the risk of static sparking and electric shock. Electric or static sparking can cause fumes to ignite or explode. Improper grounding can cause electric shock. Grounding provides an escape wire for the electric current.</p>			

Air and fluid hoses: Use only electrically conductive hoses with a maximum of 500 ft. (150 m) combined hose length to ensure grounding continuity. Check electrical resistance of the hoses. If total resistance to the ground exceeds 29 megohms, replace the hose immediately.

Machine: Grounded through the supplied power cord.

Air compressor: Follow manufacturer's recommendations.

Dispense valve: Ground through connection to a properly grounded fluid hose and pump.

Fluid supply container: Follow local code.

Solvent pails used when flushing: Follow local code. Use only conductive metal pails, placed on a grounded surface. Do not place the pail on a non-conductive surface, such as paper or cardboard, which interrupts grounding continuity.

To maintain grounding continuity when flushing or relieving pressure: Hold the metal part of the dispense valve firmly to the side of a grounded metal pail, then trigger the valve.

Startup

For the location of components on the C-300, refer to **Figure 1** on page 8. For the location of components on the C-500, refer to **Figure 2** on page 9.

Start the System

1. Depending on the UniXact model, ensure that the part access door is closed or that the light curtain is not interrupted.
2. Turn the system power switch to the On position. The switch is located on the front of the C-300 (K) and C-500 (AK).
3. Verify that air is supplied to the system. Push the yellow slide valve on the air inlet to the up position.

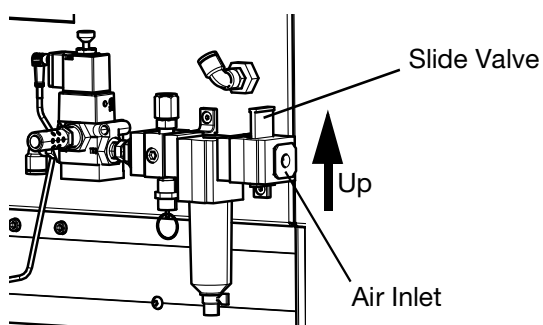
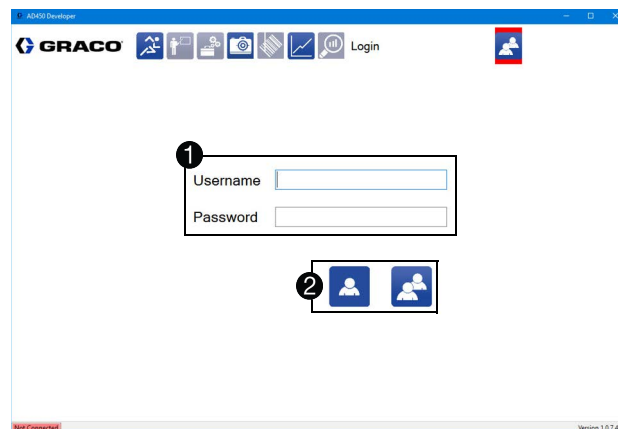

FIG. 7: Supply Air to the System

4. Turn on power to the machine by pressing the green control power button (G - C-300; AH - C-500) on the front of the machine.
5. Each system comes with a computer and touch screen monitor (B - C-300, AB - C-500). Turn on power to the computer monitor.
6. When starting the system the first time, you need to activate the Microsoft® Windows® software. Make sure you reset the time and time zone if it is different from what was set when the software was installed at the factory.
7. Restart the computer using the Windows start menu.
8. If the UniXact system software does not automatically start after you restart the computer, select the Graco icon on the Windows desktop.

Log In

The Log In screen is the UniXact system software's main screen that provides access to the system and its functionality. There are three levels of access to the system: Operator, Technician, and Engineer.



To log in, use the user name and password fields **1** and the system access icons **2**.



Operator Log In: Select this icon to automatically log in without a user name or password if you have Operator level access only. Users with Engineer and Technician level access must use the user name and password fields and the standard Log In icon.



Log In: Select this icon to complete the log in after entering your user name and password.

The default user names and passwords are:

User Name	Password
Operator	Operator
Technician	Technician
Engineer	Engineer

1. To log in as a Technician or Engineer the first time, enter the default password.

2. Click on the  icon.

Once you are logged in, you are automatically connected to the system. This enables you to create and download new programs, change parameters, check the status, or run existing programs.

NOTE: Only one user can be logged in at a time. Logging in a new user logs out the previous one.

After you are logged in and connected to the system, you will see your user name displayed in the upper-right corner of the Log In screen, next to the Log In screen icon ①.



See **System Functions** on page 16 for a description of the Log In screen icon and the system navigation icons at the top of the screen.

If you have Engineer level access, when you return to the Log In screen, you will see an extra icon to edit the Users list ②.



Edit Users: Edit the list of users, their passwords, and their access levels. This icon is only visible if an administrator (Engineer) is logged in.

Edit Users

To edit user information with Engineer level access,

select the  icon on the Log In screen. This opens the Edit User window.

At the Edit User window, the defaults can be changed and new names and passwords can be added. If the password file is deleted or corrupted at any time, a new file is generated with the default passwords.

1. Select a name from the Users list ①.
2. Change the name and password for the currently selected user as needed ②.
3. If necessary, change the access level for the selected name ③.

NOTE: User names must be unique. Passwords are not required to be unique.

4. Delete or edit all default users and passwords to prevent unauthorized access or tampering with software.

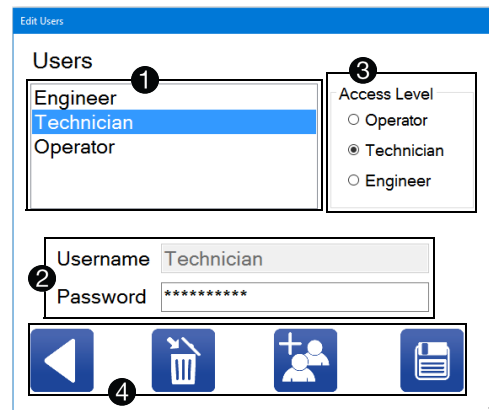

General controls for editing users are located at the bottom of the screen ④.



Back: Return to the login screen. No changes that were made on the edit screen are saved.



Delete User: Remove a user name and password from the database.



New User: Create a new user with a default user name, password, and access level. The user name, password, and access level can be changed after the user has been created.



Save Changes: Save any changes made to the user database. If the Save icon is not selected, changes are not saved.

NOTE: While Operators can access the system without entering a user name and password, the option of assigning Operator passwords is offered for customer applications that require everyone who accesses the system to log in.

Connecting to the Motion Controller

The UniXact system software automatically connects to the system's motion controller when you log in. If for some reason the system does not automatically connect, you can double click or double tap on the connection status indicator in the lower left corner of the screen to open the Connect to Dispenser window. The location of the system status indicator is shown in **System Functions** on page 16.

This window shows IP addresses that are available for connection ❶. The list includes valid controllers within the range specified by the development computer's IP address and subnet mask. Controllers to which the software has been recently connected appear on this list. The list also contains an option for you to input a known IP address.

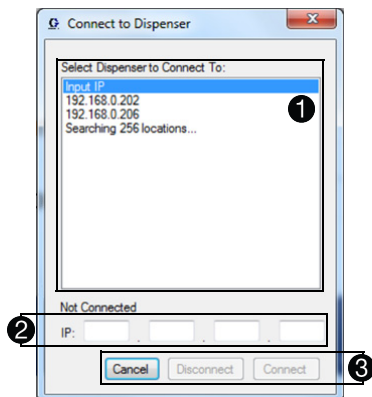

Select the Input IP option from the list of potential controller IP addresses to enter a specified IP address in the input box ❷. The connection options are ❸:

- **Cancel** - Exit the connection screen and return to the main program.
- **Disconnect** - Disconnect from the currently connected controller.
- **Connect** - Connect to the specified IP address. If a controller is already connected, the system automatically disconnects from that controller.

NOTE: In many cases, the motion controller for the machine you are using, which is located in the access panel in the base of the machine, may be the only one on the list. This list is helpful if you are networking to multiple machines. The default IP address for a non-networked machine is 192 168 000 200.

When the computer and motion controller are connected and communicating, there is a green “Connected” message in the lower-left corner of the screen. The system status and alarm bars near the top of the

Run screen show the status of the machine. An  icon on the right side of the alarm bar indicates active alarms. See **System and Alarm Status** on page 61 for information.

When you connect, the software should be preloaded on the motion controller. If the software is not present or is out of date, one of two error messages could appear:

- The Controller version could not be read. This indicates a problem with the file system. Reinstall files?
- The Controller software and the developer software are incompatible. Reinstall the controller file? (This message shows both software version numbers.)

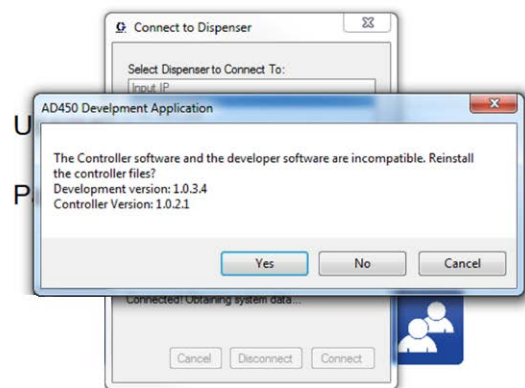
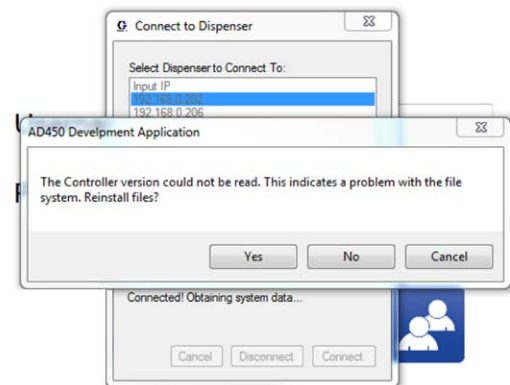

Select Yes in response to the error message. Then, when prompted, select the zipped controller files that you received with the system.

NOTE: If you receive a message that the controller is not authorized, contact a Graco representative to obtain the software to authorize the controller to use the dispenser software.

System Functions

The icons at the top of the log in screen ❶ provide access to the UniXact system functions.

NOTE: These icons remain displayed at the top of the screen for navigation purposes even when you access one of the system’s functions. The icon for the function you are currently using is highlighted in red.

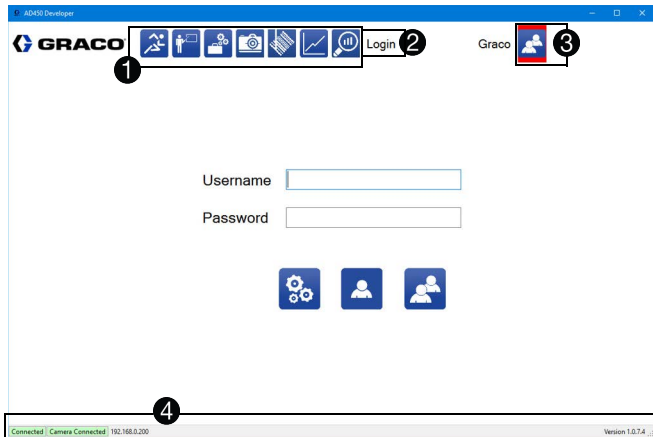

The following icons represent the functions currently available for standard or custom use as of the date of this manual’s publication:



Run: Selecting this icon opens the Run screen, which allows you to run programs downloaded to the controller. The icon is not enabled if the motion controller is not connected.



Teach: Selecting this icon opens the programming screen, which allows you to create a new motion program, modify an existing motion program, and download motion programs to the controller. Part of the program development is to teach the machine the design of the part.



Maintenance: Selecting this icon opens the maintenance screen, which allows you to jog the machine, view the state of the inputs, toggle outputs, and edit parameters.



Live Camera View: Selecting this icon opens a pop up window that displays the live camera view. For this feature to function, the optional camera must be installed and the vision feature must be enabled on the Parameters screen.

Barcode Reader: Selecting this icon opens the barcode screen that allows specific barcode reading features to be associated with a UniXact program. The barcode option must be enabled on the Parameters screen for this function to be available.



Graph: Selecting this icon dynamically displays pressure data for the Analog 1 and/or Analog 2 channels. The analog channels must be enabled in the parameters. This feature requires the optional pressure transducers. See **Analog Inputs** parameters on page 30.



SPC Data: Selecting this icon opens the SPC screen, which provides historical data about the currently connected system.

NOTE: The icons are not visible on the screen until you log in. The icons appear gray if you do not have access to the functions and blue when accessible.

The name of the function you are currently using is displayed just to the right of the main program functions ❷.

The Log In screen icon is located in the upper-right corner of the screen ❸.



Log In: This icon provides a shortcut to the Log In screen when you are navigating between system functions.

General system information is displayed at the bottom of all screens ❹. In the lower-left corner is the connection status of the system: either connected or not connected. The software automatically connects to the motion controller when log in. However, if it does not automatically connect, you can double click or double tap on the “not connected” status to open the Connect to Dispenser window. See **Connecting to the Motion Controller** on page 15 for more information.

In the lower-right corner is the version number of the development software.

Setup

Maintenance and Load/Unload Positions

The UniXact machines are equipped with sensors to verify that the X and Y axis are in a position for maintenance or for loading and unloading parts. Typically, the maintenance position is located so the axes are closest to the front in the Y direction and to the far right side of the work area in the X direction.

The load/unload position is normally located towards the back in the Y direction and to the far right side of the work area in the X position. There is limited adjustment in the positioning of these switches.

There are three sensors used to define these positions: one on each end of the Y axis and one on the Z axis as shown in **Figure 8**. The Y axis position is determined by either the load/reload sensor or the maintenance sensor. The X and Z axis positions are determined by the dispenser sensor mounted to the Z axis and the sensor target mounted on the X axis. See **Safety Circuit Design** on page 89 for more information.

NOTE: When these sensors are activated, the LED located near the cord end of the sensor is illuminated.

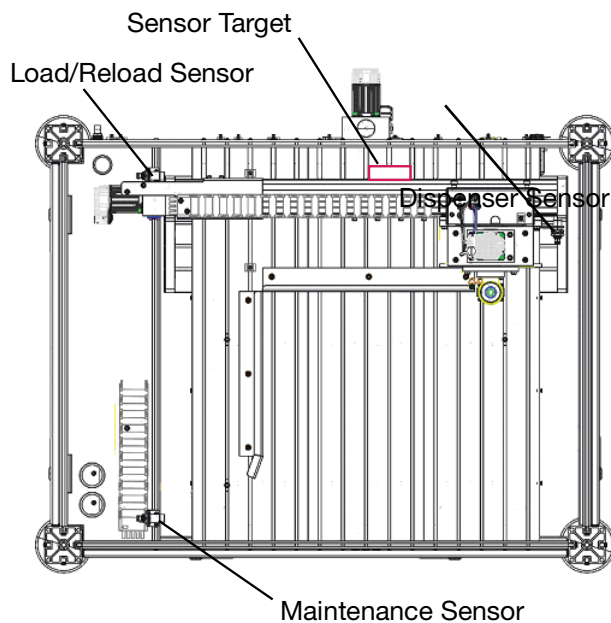



FIG. 8: Positioning Sensor Locations

The sensor positions need to be taught and saved in the Maintenance and Part Load parameters. See **System Parameter Descriptions** on page 23 for information about setting these parameters.

NOTE: Care must be taken when setting parameters to ensure there is adequate offset from the over-travel positions to prevent nuisance alarms.

Maintenance Screen Functions

Select the  icon from the system function menu to open the Maintenance screen.

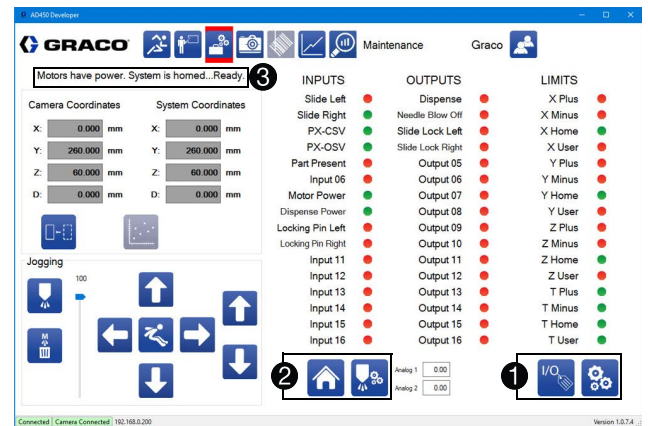

General controls are located along the bottom of the screen **1**, **2**.



Home: Initiates a homing routine that sets the dispenser to its starting position to enable locating X, Y, and Z positions on a part. Homing is required after any loss of motion power. This icon is disabled if the system is e-stopped.



Maintenance Position: This position causes the machine to move to a pre-defined maintenance position. The machine does not move to this position if it has not been homed or if it is currently running a program, a purge, or the needle find routine. See **Maintenance and Load/Unload Positions** on this page.



I/O Labels: This feature allows you to edit the current input and output (I/O) labels. I/O labels are stored specific to each machine. Each set of I/O should have unique labels. This icon is not visible unless a technician or higher access is logged in.



Parameters: This feature provides access to the parameters. The parameters list and the I/O data cannot be viewed simultaneously. This button is not visible unless a technician or higher access is logged in.

The system status is displayed in the upper-left corner of the Maintenance screen ③. If there are multiple alarms, only the most recent alarm is displayed.

Manage Inputs and Outputs

Although the UniXact machines are fully inspected and tested at the factory, verifying the inputs and outputs provides a good understanding of the equipment and how to make adjustments to minimize the possibility of issues during startup.

Selecting the I/O icon in the lower right corner shows the inputs, outputs, and over-travel limits if they are not currently displayed on the screen when you access it.

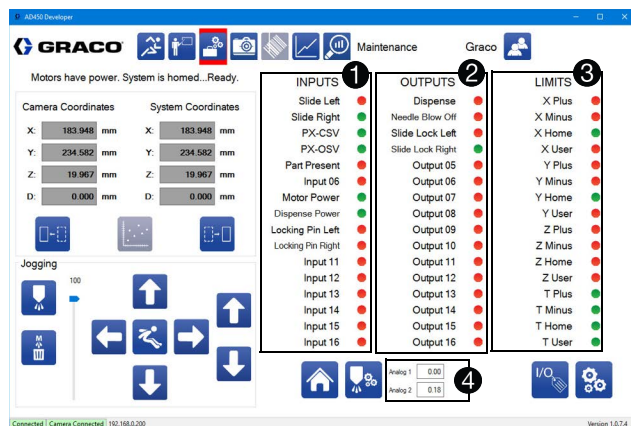

The inputs are displayed in the left column of the input and output data ①. There are 16 inputs available.

The central column shows the 16 outputs ②. The state of each output can be toggled by selecting it, which can assist with troubleshooting.

The over-travel limits are in the right column ③. Each of the three axes has a positive limit, a negative limit, a home input, and a user input.

The analog inputs are displayed at the bottom of the screen ④. The inputs displayed are scaled based on system parameters.

The labels for the inputs, outputs, over-travel limits, and analog inputs can be edited.

1. Select the I/O icon. This places text boxes around all of the labels that can be changed.

NOTE: When in editing mode, the I/O icon changes to a document icon.

2. Select the field you want to change and type the new label.
3. Repeat for all labels that need to be changed.
4. Select the document icon to save your changes.

Verify that the inputs and outputs are functioning properly by activating the input and output switches as described in **Input/Output Test Procedure** on page 86.

Here is a listing of the inputs, outputs, and limits at they are typically assigned. They may vary from one machine to another.

INPUTS	
1	Slide or Part in Fixture - Left*
2	Slide or Part in Fixture - Right*
3	PD44, 1053, 1093 Reload (PX-CSV)*
4	PD44, 1053, 1093 Dispense (PX-OSV)*
5	Part Present*
6	Spare: Exp-1, LVL1-Warning†
7	Motion Power
8	Dispense Power
9	Locking Pin or Part In Fixture - Left*
10	Locking Pin or Part in Fixture - Right*
11	Start Button*
12	LVL1-Alarm*
13	Spare: Exp-2, PR70 Fault†
14	Spare: Exp-3, PR70 Ready†
15	Spare: Exp-4, LVL2-Warning†

16	Spare: Exp-5, LVL2-Alarm†
OUTPUTS	
1	Dispense*
2	Blow Off*
3	Slide Lock Left*
4	Slide Lock Right*
5	Output 5*
6	Vision Camera Trigger*
7	Spare: Exp-2†
8	Spare: Exp-1†
9	Spare: Exp-10 or PR70 Shot Sel Bit 3†
10	Spare: Exp-9 or PR70 Shot Sel Bit 2†
11	Spare: Exp-8 or PR70 Shot Sel Bit 1†
12	Spare: Exp-7 or PR70 Shot Sel Bit 0†
13	Spare: Exp-6 or PR70 Interrupt†
14	Exp-5 System Fault†
15	Exp-4 System Ready†
16	Spare: Exp-3†
LIMITS	
1	X Plus (+) Limit
2	X Minus (-) Limit
3	X Spare Limit
4	X Needle Find
5	Y Plus (+) Limit
6	Y Minus (-) Limit
7	Y Spare Limit
8	Y Needle Find
9	Z Plus (+) Limit
10	Z Minus (-) Limit
11	Touch Sensor (Pitch and Roll)
12	Z Spare Limit
13	Dispenser Plus (+) Limit
14	Dispenser Minus (-) Limit
15	Dispenser Home Limit
16	Dispenser Spare Limit

* Assigned on the controller interface board, part no. 24X999.

The I/O screen display is conditioned for normally closed switches (it appears green when the switch is activated and the contact is open.)

The PD44 uses normally closed switches; the 1053 uses normally open switches.

† Spare inputs and outputs are accessible through the expansion I/O accessory board, part no. 25A479. Typical usages are listed after each expansion address, where applicable.

Select Axes Coordinates

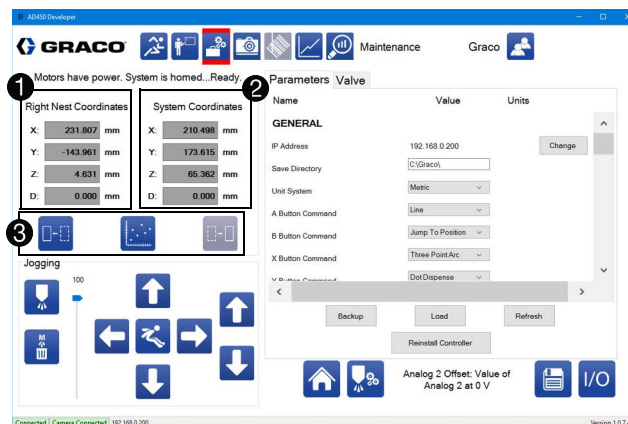

The coordinates for the current position of the part are located on the left ①. You can select the coordinate system to be shown. The text above the coordinates indicates the coordinate system currently selected.

The System Coordinates on the right show the position of the axes in general machine coordinates ②.

NOTE: This position does not include the Z offset value. The actual position of the needle tip may vary for two different needles with identical machine coordinates due to the varying length of the mixer/dispense tip assembly. See **Needle Find** parameters on page 27.

You can select between the left nest (where the part is held on the slide) coordinate system, the right nest coordinate system, or machine coordinates. The icon for the coordinate system turns gray when you select it ③.



Left Nest: Switch to the coordinate system for the left nest. The offset for this coordinate system can be set at the Machine Offset parameters. See **Machine Offsets** parameters on page 25 for more information.



Machine Coordinates: Switch to general machine coordinates. This is the coordinate system used for purging and the needle find process and for locating the origin of the left and right nest. The zero for this system is set by the homing routine.



Right Nest: Switch to the coordinate system for the right nest. The offset for this coordinate system can be set at the Machine Offset parameters.

System Jogging

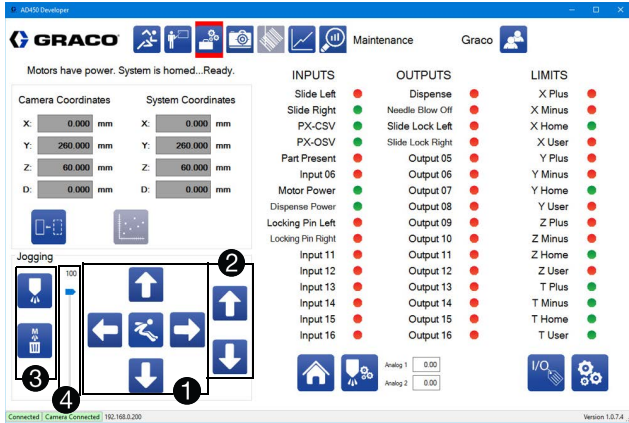

The system jogging controls allow you to operate the dispense axes to test and purge the system and to select coordinates when setting parameters.

Jogging controls are also used when programming parts. See **Teaching Points** on page 52.

Use the central jog controls to jog the system in X and Y, as well as to jump to a specific point ①.

NOTE: Touching an arrow moves the dispenser incrementally. To jog continuously, touch and drag or slide the arrows.



Positive Y Jog: Move the Y axis in the positive direction, which is away from the front of the machine. The axis continues to jog for as long as the icon is pressed. This icon is disabled if the system is not in a state to allow jogging.



Negative Y Jog: Move the Y axis in the negative direction, which is toward the front of the machine. The axis continues to jog for as long as the icon is pressed. This icon is disabled if the system is not in a state to allow jogging.



Positive X Jog: Move the X axis in the positive direction, which is towards the right side of the machine. The axis continues to jog for as long as the icon is pressed. This icon is disabled if the system is not in a state to allow jogging.



Negative X Jog: Move the X axis in the negative direction, which is towards the left side of the machine. The axis continues to jog for as long as the icon is pressed. This icon is disabled if the system is not in a state to allow jogging.



Jump to Position: Open a new window that allows you to input coordinates to where the system jumps. This icon is disabled if the system is not in a state to allow jogging.

The jogging controls on the right are for the Z axis ②.



Positive Z Jog: Move the Z axis in the positive direction, which is up away from the nest. The axis continues to jog for as long as the icon is pressed. This icon is disabled if the system is not in a state to allow jogging.



Negative Z Jog: Move the Z axis in the negative direction, which is towards the nest. The axis continues to jog for as long as the icon is pressed. This icon is disabled if the system is not in a state to allow jogging.

NOTICE	
Jog speed for the Z axis should be set to a slow speed (5 mm/s or less). High jog speeds can result in crashing the dispenser and damaging the dispenser parts or nest.	

Dispense controls appear to the far-left of the jogging controls ③.



Shot Dispense: Cause the dispenser to dispense a test shot. The dispenser speed and the duration of dispense for the test shot are set in the parameters.



Manual Purge: Trigger a manual purge. As part of this purge, the machine moves to the purge location.

The jogging controls include a slider bar that controls the jog speed as a percentage of the maximum speed, which is set in the parameters ④. The maximum speed of each axis can be set independently. This adjustment is only active while the screen is open and does not affect jog speed using a teach pendant.

System Parameter Overview

The UniXact system's parameters play an essential role in controlling the operation of the UniXact machines.

There are two categories of parameters:

- General System Parameters
- Valve Parameters.

Within the general system parameters, there are location, application-specific, and machine configuration types of parameters.

See **Appendix F: Parameters Worksheets** on page **101** for a worksheet to record and reference system parameters.

Location Parameters

Location parameters teach the system software where physical components are in the work area.

NOTICE

If the locations are not taught prior to running the machine, the system could be damaged by running into obstacles. These locations are typically taught at the factory, but should be verified and adjusted as necessary before running the machine the first time.

The settings can change depending on the physical location of the hardware in the work area. The locations can even be slightly different on identical machines running the same application.

Location parameters include the following:

- Needlefind
- X/Y/Z Purge Location
- Machine Offset Parameters - Left Nest Pitch/Roll, Right Nest Pitch/Roll, Left Nest Zero X/Y/Z, and Right Nest Zero X/Y/Z
- Part Presence
- Maintenance X/Y/Z

Application-specific Parameters

These parameters are unique to your application and may take some testing and experimenting to determine the parameter settings that work best.

These can be affected by material being dispensed, material gel time, material temperature, dispense rate, dispense pressure, production rate, and the production environment (temperature and humidity).

The following application-specific parameters may need to be adjusted from time-to-time if any of those factors change:

- Smoothness
- Dispenser Reload Speed
- Purging - other than location parameters
- Analog Input Parameters

Machine Configuration Parameters

These parameters affect the speed of the machine, the functionality of the teach pendant (see **Using a Teach Pendant** on page **55**), and the file save locations. The factory defaults for these parameters can be used initially. You can make adjustments as the application is refined. Machine configuration parameters include the following:

- General Parameters
- Running Parameters
- Homing Parameters
- Jogging Parameters
- System Limits

Dispense Valves

It is important to select the dispense valve being used in your system during this process. See **Valve Parameter Descriptions** on page **32** for more information.

Set and Verify Parameters

Because the UniXact machines are wet tested at the factory, starting parameters should be set appropriately for your system. However, you should review and verify these parameters so you can understand what each parameter does and how it can be adjusted and used to improve your process.

At the Maintenance screen, select the  icon to access the parameters list. Technician level access or higher is required.

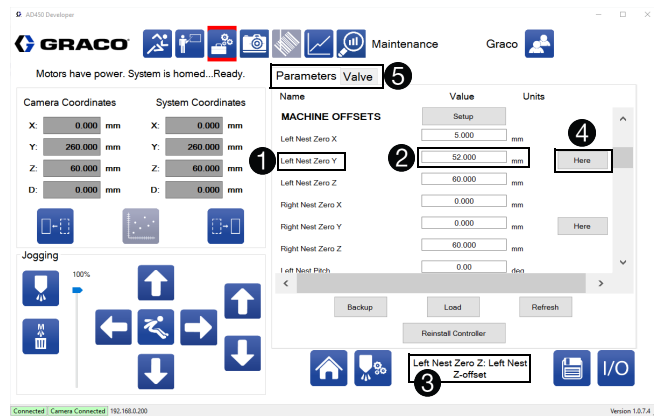

Changing parameters modifies the operation of the machine. Parameters that are changed are immediately updated in the system. However, the saved parameters file, which is used to restore parameters after a power cycle, is only updated when you exit the parameters function.

Each parameter has a unique name listed in the left-most column **1**.

Parameters can be adjusted by inputting a new value in the central column **2**.

There is a description field for parameters at the bottom of the screen **3**. Select a parameter to see a description of that parameter in this field.

Location parameters have a Here button associated with them **4**. When you are setting or changing a location parameter, select this button to confirm coordinates after you have used the jogging controls to select them. If the Here button is only located next to the Y-value, the X, Y, and Z parameters are all set. Otherwise, only the parameter next to the Here button is set.

Use the tabs at the top to toggle between system parameters and valve-specific parameters **5**.

There are two important icons located in the lower right corner of this screen **6**.



Save: Select this button to save the parameters file and send it to the controller. This is the only way to save changes made to the parameters.



Input/Output: Use this to return to the Input/Output screen. If parameters have not been saved, a message about discarding changes is presented.

The methods for setting or changing a parameter depends on the type of parameter. Some require you to select from drop down menus while others have you use the jogging controls or enter values. See **System Parameter Descriptions** on page 23 for more information.

Manage the Parameters File

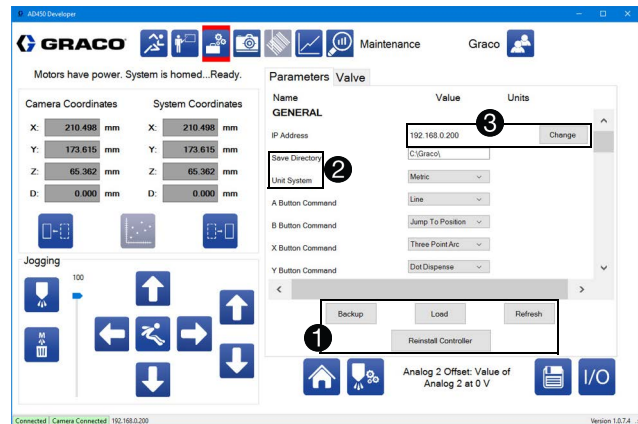

Buttons below the scrolling parameters list initiate functions for managing the Parameters file **1**.

NOTE: The Parameters files used by the system are saved in the C:\Graco folder on the local computer. The location and name for these files cannot be changed. Backup files can be saved to a different file location.

Backup: Select this button to create a copy of the current Parameters file and store it locally in a location you select. Only the default file name can be used and any existing file with that name is overwritten if the same location is used repeatedly.

Load: Select this button to send a previously made backup file to the controller, and to set all the parameter values accordingly.

Restore: Select this button to have the system re-load the Parameters file from the last save, undoing any changes you have made to any of the parameters.

Reinstall Controller: Select this button to reinstall the files on the controller, provided the appropriate files are stored on the local computer. Engineering level user access is required to perform this function.

The following two parameters have specific importance and need to be set correctly before using your UniXact system ②:

Save Directory: The Parameters file includes a Save directory for the programming files that are created. The default value is restored if the Save directory ceases to exist.

Unit System: This is used to display the system in metric or standard units.

Change the System IP

Select the Change button next to the listed IP address to open the dialog box that allows you to change the IP address of the connected controller ③.

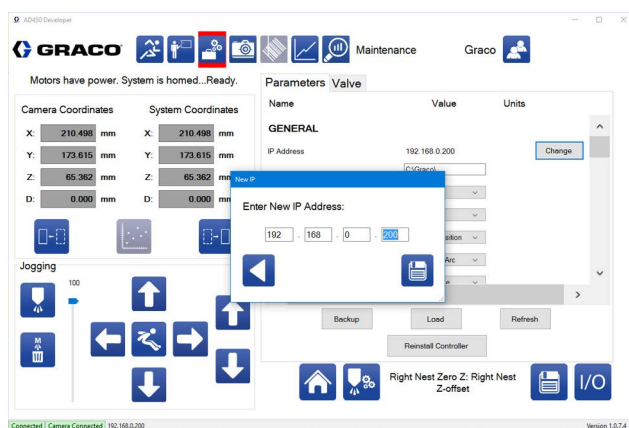

Back: Return to the parameters list without changing the IP address of the connected controller.



Save IP: Save and change the IP of the connected controller. The system attempts to reconnect automatically.

System Parameter Descriptions

This section provides descriptions of the general system parameters.

NOTE: Due to the various options available for the UniXact systems and the diversity of applications, not all of these parameters may be appear in the list for your system.

You can also check for a supplement with updates to the parameters and additional information in the Graco Dispenser Documentation folder on the system computer's desktop.

General

IP Address: The IP address of the currently-connected controller is listed. To change it, select the button labeled Change located next to the listed address.

Save directory: The directory used for saving and loading part files. If this directory does not exist, a folder named Parts in the same directory as the executable is used instead. Only part files in the Save directory are accessible through the Programming screen.

Unit system: Select whether the system uses standard or metric units. Standard units are in inches or inches/second. Metric units are in mm or mm/second.

Game Controller Command Buttons - A (green), B (red), X (blue), and Y (yellow): These buttons can be programmed to call up the program commands you use the most. The functions are available through a drop down menu.

Number of Nests: Enter either 1 or 2. Enter 2 if the machine is equipped with dual Y-slides or if Part in Fixture sensors are being used to identify two different parts. Enter 1 if neither of those are occurring.

Each part nest has its own coordinate system and origin (zero point). This allows a program with the same coordinates to be used in both nests.

Part in Fixture Sensors: Enable or disable this feature. When enabled, it requires the Part in Fixture sensors to be activated before the axes are enabled to run a part in Run mode. This feature is always used when there are Y-slides. When there are no Y-slides, inputs for the left and right nest can be used to detect different parts and select the appropriate left or right program. The same inputs that are used to indicate a slide is pushed in and locked in place are used for the Part in Fixture sensors.

- Activate inputs 1 and 9 to enable the left nest.
- Activate inputs 2 and 10 to enable the right nest.
- Inputs 1 and 2 are normally closed switches and must be held open to activate.
- Inputs 9 and 10 are normally open switches and must be held closed to activate.
- When the number of nests is one (1), left nest parameters apply.

When Part in Fixture is enabled

- When a slide is pushed in, the slide sensor activates input 1 on the left slide or input 2 on the right slide.
- The slide then locks in and activates the locking pin sensor input 9 on the left slide or input 10 on the right slide.
- When no slides are present, these inputs are typically triggered by two sensors that are part of the tray locator assembly. Each sensor is positioned to detect a side of the part or fixture to ensure the part is positioned properly against the stops.
- When these two Part in Fixture inputs are triggered, the dispense program automatically begins.

When Part in Fixture is disabled

- It is necessary that you use a Wait for Input as the first command in the part program. Otherwise, the part program starts immediately after the machine is placed in Run mode, which could affect dispensing.
- The Wait for Input command requires an action to occur to allow the program to run. The input is typically addressed to a start push button.
- There is no condition (outside of the program) that needs to be met to start the part program when the Part in Fixture is disabled.

Level Sensor Installed: Select Enabled to allow material level status messages to appear on the Run screen when a level input is received. This feature requires normally open contacts to be installed on the inputs. A material level error or event closes the contact and triggers a warning or alarm message.

The following material level status messages can appear depending on the inputs where the normally open contacts are installed.

PC Input	Message
12 (controller interface board P20)	Alarm Material A Level Error
16 (I/O expansion board IN 5)	Alarm Material B Level Error
6 (I/O expansion board IN 1)	Warning - Material A Low
15 (I/O expansion board IN 4)	Warning - Material B Low

NOTE: For alarm messages, the machine shows the message then automatically exits the Run mode. For warning messages, the machine shows the message but continues normal machine operation.

Preventative

Cycles to PM: Enter the desired number of cycles that can be run before the preventative maintenance warning appears. The count value for this feature is accumulated based on the Total Cycles counter located on the SPC Data screen. It is also displayed as Cycles on the Run screen.

Running

Smoothness: Smoothness is represented by a percentage from 0 to 100%. Lower values cause the system to adhere more closely to the predefined path. Higher values allow greater rounding at corners or inside arcs. A value of 3 is good for most applications. This value can be adjusted later after a dispense program is developed, to smooth motion while dispensing.

X Rapid Rate: The maximum speed at which the system can move the X-axis during rapid movements, such as Jump To Position commands.

Y Rapid Rate: The maximum speed at which the system can move the Y-axis during rapid movements, such as Jump To Position commands.

Z Rapid Rate: The maximum speed at which the system can move the Z-axis during rapid movements, such as Jump To Position commands.

Homing

X Homing Rate: The speed at which the system moves the X-axis during homing.

Y Homing Rate: The speed at which the system moves the Y-axis during homing.

Z Homing Rate: The speed at which the system moves the Z-axis during homing.

Jogging

X Jogging Rate: The default speed at which the system moves the X-axis during jogging. This is the maximum speed if using a connected joystick.

Y Jogging Rate: The default speed at which the system moves the Y-axis during jogging. This is the maximum speed if using a connected joystick.

Z Jogging Rate: The default speed at which the system moves the Z-axis during jogging. This is the maximum speed if using a connected joystick.

Machine Offsets

Setup Button: Launches the setup utility for calibrating part nests. See **Calibrate the Machine** on page 66.

Left Nest Zero X: The X-coordinate for the origin of the left nest. The left nest origin is used as the starting point for any program run on the left nest, corresponding to (0,0,0) on the Programming screen.

Left Nest Zero Y: The Y-coordinate for the origin of the left nest. The left nest origin is used as the starting point for any program run on the left nest, corresponding to (0,0,0) on the Programming screen.

Left Nest Zero Z: The Z-coordinate for the origin of the left nest. The left nest origin is used as the starting point for any program run on the left nest, corresponding to (0,0,0) on the Programming screen.

Right Nest Zero X: The X-coordinate for the origin of the right nest. The right nest origin is used as the starting point for any program run on the right nest, corresponding to (0,0,0) on the Programming screen.

Right Nest Zero Y: The Y-coordinate for the origin of the right nest. The right nest origin is used as the starting point for any program run on the right nest, corresponding to (0,0,0) on the Programming screen.

Right Nest Zero Z: The Z-coordinate for the origin of the right nest. The right nest origin is used as the starting point for any program run on the right nest, corresponding to (0,0,0) on the Programming screen.

Left Nest Pitch: The angle the left nest is rotated about the X-axis.

Left Nest Roll: The angle the left nest is rotated about the Y-axis.

Left Nest Skew: The angle the left nest is rotated about the Z-axis.

Right Nest Pitch: The angle the right nest is rotated about the X-axis.

Right Nest Roll: The angle the right nest is rotated about the Y-axis.

Right Nest Skew: The angle that the right nest is rotated about the Z-axis.

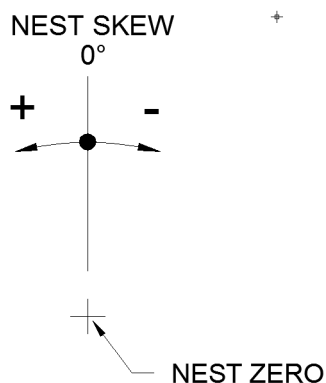

Fig. 9: Left and Right Nest Skew

Part Presence

Use Part Sensor: Checking this box determines whether or not the system moves to the part present location and checks the part present sensor before running a part program.

Left Part Present X: The X-coordinate of the position the system moves to when determining if there is a part present in the left nest.

Left Part Present Y: The Y-coordinate of the position the system moves to when determining if there is a part present in the left nest.

Left Part Present Z: The Z-coordinate of the position the system moves to when determining if there is a part present in the left nest.

Right Part Present X: The X-coordinate of the position the system moves to when determining if there is a part present in the right nest.

Right Part Present Y: The Y-coordinate of the position the system moves to when determining if there is a part present in the right nest.

Right Part Present Z: The Z-coordinate of the position the system moves to when determining if there is a part present in the right nest.

Purging

NOTE: To start a process, select a purge amount that dispenses the full volume of mixed material in the mixer in 1/2 to 3/4 of the gel time of the material. These are highly material-dependent.

X Purge Location: The X-coordinate of the location the system moves to prior to initiating a purge. The purge location is the same for all types of purging.

Y Purge Location: The Y-coordinate of the location the system moves to prior to initiating a purge. The purge location is the same for all types of purging.

Z Purge Location: The Z-coordinate of the location the system moves to prior to initiating a purge. The purge location is the same for all types of purging.

Purge Warn Time: The time in seconds that you are warned before the purge occurs. The warning is indicated on the run screen by highlighting the elapsed time value in red to alert of the imminent purge.

Needle Blowoff Time: The time in seconds in which air is applied to the needle tip after a purge to blow excess material off of the needle. After half the time has elapsed, the Z axis starts to move to its up position. The blow off remains on for the rest of the time while the Z axis is moving up.

Purge Frequency: The time in seconds between standard purges. The standard purge timer is reset any time the system undergoes any type of purge. The time also is reset any time the system dispenses, causing the system not to undergo standard purges during continuous running.

Purge Shot Count: The number of shots dispensed during a standard purge. A shot consists of moving the dispense valve the distance detailed in the purge amount parameter.

Purge Dwell Time: The time in seconds the system waits after each shot and before blow-off (if active) while performing a standard purge.

Process Purge Frequency: The number of parts dispensed between process purges. The process purge counter is reset any time the system undergoes any type of purge. Process purges interrupt continuous running of the system.

Process Purge Shot Count: The number of shots dispensed during a process purge. A shot consists of moving the dispense valve the distance detailed in the process purge amount parameter.

Process Purge Dwell Time: The time in seconds the system waits after each shot and before blow-off (if active) while performing a process purge.

Needle Find

When setting the needle find sensor location parameters, keep in mind that these parameters must be set to allow the needle to travel through both sensors by moving in positive X and Y, respectively. The diagram below depicts the appropriate position to set the needle find sensor location, given the two sensors positioned on the sides of a square.

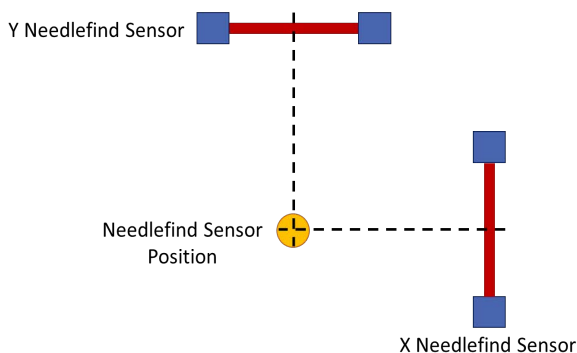

Fig. 10: Setting Needle Find Sensor Location

NOTE: Prior to teaching the needle find sensor position, the machine must be homed without the needle find option activated. This establishes the axis position with respect to the hard-wired over-travel position switches on each axis.

The needle find position must be established and the home routine (with needle find option activated) must be performed before positions for other features are taught. The needle find routine establishes the exact position of the dispense tip in the coordinate system by using the needle find sensor location as a fixed reference.

The dispense tip is then used to teach the location of the following features:

- Purge Position
- Machine Offsets
- Part Present Sensors

Any changes to the location of the needle find sensor location parameters changes the location of the dispense tip in the coordinate system and affects the position of the feature locations listed above. If the needle find sensor location is changed, the feature locations change accordingly and must be re-taught. Any programs written prior to the change are also affected.

When it is necessary to change the needle find position after it has been established, tip offset values can be added to move the needle find position relative to the originally taught sensor location without changing the sensor location coordinates. This allows the feature locations listed above to remain unchanged.

Enable Needlefind: Checking this box causes the system to perform a needle finding routine immediately after homing. The location of the needle is used as a secondary offset for all future moves.

Needlefind Tip X Offset: The offset for the sensor X location. This may be required due to an altered X axis positioning of the needle. This value may be changed even if the sensor has not physically moved. When the sensor location is taught, this value should be set to zero.

Needlefind Tip Y Offset: The offset for the sensor Y location. This may be required due to an altered Y axis positioning of the needle. This value may be changed even if the sensor has not physically moved. When the sensor location is taught, this value should be set to zero.

Needlefind Tip Z Offset: The offset for the sensor Z location. This may be required due to an altered needle (longer or shorter). This value may be changed even if the sensor has not physically moved. When the sensor location is taught, this value should be set to zero.

Needlefind Sensor X Location: The X-coordinate to which the system moves to initiate needle find. This value should not be changed unless the physical location of the sensor changes.

Needlefind Sensor Y Location: The Y-coordinate to which the system moves to initiate needle find. This value should not be changed unless the physical location of the sensor changes.

Needlefind Sensor Z Location: The Z-coordinate to which the system moves to initiate needle find. This value should not be changed unless the physical location of the sensor changes.

Circle Calibration Needle Location X, Y, Z: This is only used on systems with the vision feature enabled. The taught position (system coordinates) of the axes is set so the dispense needle is positioned in the center of the calibration dot on the needle find assembly. This position is used to teach the relationship between the camera and the needle.

Maintenance

Maintenance X: The X-coordinate of the maintenance position. The system moves to this position when requested to from the maintenance screen.

Maintenance Y: The Y-coordinate of the maintenance position. The system moves to this position when requested to from the maintenance screen.

Maintenance Z: The Z-coordinate of the maintenance position. The system moves to this position when requested to from the maintenance screen.

Part Load

NOTE: This feature is only for systems with light curtains. It is not available on systems with an access door.

Part Load Enable: Select Enabled to allow muting of the safety circuit when the machine is in the Load/Unload position. During normal operation, attempting to access the work area through the light curtain disables the machine. When the safety circuit is muted, you can load and unload parts without disabling the machine.

The rear mute switch on the Y axis and the mute switch assembly on the X and Z axes must be activated to mute the safety circuit. The axes automatically move to the Part Load coordinates when the machine is placed in Run mode and again after each part is completed.

When Disable is selected, the machine does not automatically index to the Part Load coordinates. Also see **Safety Circuit Design** on page 89.

Part Load X: The X-coordinate of the load/unload position. The system moves to this position after a part is dispensed.

Part Load Y: The Y-coordinate of the load/unload position. The system moves to this position when requested to from the maintenance screen.

Part Load Z: The Z-coordinate of the load/unload position. The system moves to this position after a part is dispensed.

Part Load Jump Height: Before the machine moves (jumps) to the part load position, the Z axis indexes to the specified Z height. The Z axis will move before moving the X or Y axes. Use this setting to ensure the dispense tip has adequate clearance above all obstacles in the dispense area.

System Limits

X Axis Acceleration: The rate of acceleration used by the motion controller to bring the X axis up to the requested velocity.

Y Axis Acceleration: The rate of acceleration used by the motion controller to bring the Y axis up to the requested velocity.

Z Axis Acceleration: The rate of acceleration used by the motion controller to bring the Z axis up to the requested velocity.

NOTE: The X, Y, and Z axis should all have the same acceleration rates. A default rate of 980 mm/sec is recommended for each axis and is set at the factory. This rate is good for all applications with up to a full load on the axes. (See load carrying capacity in **Technical Specifications** on page 109.) You may use higher acceleration rates to decrease cycle times when the axes are not fully loaded, but care should be taken to avoid rates that cause excessive noise or vibration when the axes make abrupt directional changes.

Maximum X: The maximum X-value that the system can move to. Location X parameters cannot have a value greater than this value.

Minimum X: The minimum X-value that the system can move to. Location X parameters cannot have a value less than this value.

Maximum Y: The maximum Y-value that the system can move to. Location Y parameters cannot have a value greater than this value.

Minimum Y: The minimum Y-value that the system can move to. Location Y parameters cannot have a value less than this value.

Maximum Z: The maximum Z-value that the system can move to. Location Z parameters cannot have a value greater than this value.

Minimum Z: The minimum Z-value that the system can move to. Location Z parameters cannot have a value less than this value.

Analog Inputs

There are two available analog inputs, labeled 1 and 2. These inputs get data from pressure transducers in the material stream. The location of the sensors vary depending on the application.

The standard sensors provided with the system are not amplified and utilize the amplifier circuit to scale the millivolt signal from the sensor to a 0-5 volt signal. See **Calibrate the Pressure Sensor** on page 71 to enable or disable the amplifier. Contact Graco Technical Assistance for use of other analog signal sources.

NOTE: It is generally best to place zeros in these parameters to start. This essentially turns off any pressure warnings and alarms. When the pattern is ready for production, the max and min pressures can be monitored on the Run screen to establish the appropriate warning and alarm levels.

Analog 1 and 2 Enable: Enabling the analog inputs activates the dispense pressure warning and alarm features described below.

Analog 1 at 5V: The desired value of the first analog input when the signal coming in is at 5 V. This value is used for scaling the input.

Analog 2 at 5V: The desired value of the second analog input when the signal coming in is at 5 V. This value is used for scaling the input.

Analog 1 Offset: The desired value of the first analog input when the signal coming in is at 0 V. This value is used to determine the input offset.

Analog 2 Offset: The desired value of the second analog input when the signal coming in is at 0 V. This value is used to determine the input offset.

Analog 1 Max Purge Alarm: If the Analog 1 input goes higher than this value during purging, the system raises an alarm. This value should be scaled per the Analog 1 at 5 V and Analog 1 offset parameters.

Analog 2 Max Purge Alarm: If the Analog 2 input goes higher than this value during purging, the system raises an alarm. This value should be scaled per the Analog 2 at 5 V and Analog 2 offset parameters.

Analog 1 Min Purge Alarm: If the Analog 1 input goes lower than this value during purging, the system raises an alarm. This value should be scaled per the Analog 1 at 5 V and Analog 1 offset parameters.

Analog 2 Min Purge Alarm: If the Analog 2 input goes lower than this value that during purging, the system raises an alarm. This value should be scaled per the Analog 2 at 5 V and Analog 2 offset parameters.

Analog 1 Max Purge Warn: If the Analog 1 input goes higher than this value during purging, the system issues a warning. This value should be scaled per the Analog 1 at 5 V and Analog 1 offset parameters.

Analog 2 Max Purge Warn: If the Analog 2 input goes higher than this value during purging, the system issues a warning. This value should be scaled per the Analog 2 at 5 V and Analog 2 offset parameters.

Analog 1 Min Purge Warn: If the Analog 1 input goes lower than this value during purging, the system issues a warning. This value should be scaled per the Analog 1 at 5 V and Analog 1 offset parameters.

Analog 2 Min Purge Warn: If the Analog 2 input goes lower than this value during purging, the system issues a warning. This value should be scaled per the Analog 2 at 5 V and Analog 2 offset parameters.

Analog 1 Max Dispense Alarm: If the Analog 1 input goes higher than this value during dispensing, the system raises an alarm. This value should be scaled per the Analog 1 at 5 V and Analog 1 offset parameters.

Analog 2 Max Dispense Alarm: If the Analog 2 input goes higher than this value during dispensing, the system raises an alarm. This value should be scaled per the Analog 2 at 5 V and Analog 2 offset parameters.

Analog 1 Min Dispense Alarm: If the Analog 1 input goes lower than this value during dispensing, the system raises an alarm. This value should be scaled per the Analog 1 at 5 V and Analog 1 offset parameters.

Analog 2 Min Dispense Alarm: If the Analog 2 input goes lower than this value during dispensing, the system raises an alarm. This value should be scaled per the Analog 2 at 5 V and Analog 2 offset parameters.

Analog 1 Max Dispense Warn: If the Analog 1 input goes higher than this value during dispensing, the system issues a warning. The value should be scaled per the Analog 1 at 5 V and Analog 1 offset parameters.

Analog 2 Max Dispense Warn: If the Analog 2 input goes higher than this value during dispensing, the system issues a warning. This value should be scaled per the Analog 2 at 5 V and Analog 2 offset parameters.

Analog 1 Min Dispense Warn: If the Analog 1 input goes lower than this value during dispensing, the system issues a warning. This value should be scaled per the Analog 1 at 5 V and Analog 1 offset parameters.

Analog 2 Min Dispense Warn: If the Analog 2 input goes lower than this value during dispensing, the system issues a warning. This value should be scaled per the Analog 2 at 5 V and Analog 2 offset parameters.

Vision

NOTE: Vision parameter requirements may vary by application and are subject to change based on each application's unique requirements.

Vision Enable: Select Enabled to allow or Disabled to disallow use of the Vision command and teaching program points with the camera.

Vision Camera IP: The IP address for the camera. The default factory setting for this is 192 168 000 205.

Vision Calibration Location X, Y, Z: The taught position (system coordinates) of the axes where the calibration dot is precisely located in the camera's cross hairs. The Z height of this coordinate establishes image scaling.

NOTE: The calibration dot is on a sticker with a white background and a black circle that is precisely 10 mm in diameter. See **Figure 11**. Inside the black circle is a white circle that is used to aid in the calibration process. The diameter of the inset white circle should closely match the outside dimension of the dispense needle tip that you are using for your application. A sheet of stickers (part no. 17R409) with needle gauge sizes ranging from 12 to 24 are provided with the UniX-act machines. The small black dot within the white circle is used to establish the focal distance. When this dot is crisp, you are at the correct focal distance from the target. See **Calibrate the Vision Option** on page 74.



FIG. 11: Calibration Dot Example

Circle Camera X, Y: Location values calculated when the vision calibration location is taught. Do not edit this value.

Pixel to MM Factor: A camera image scaling factor calculated when the vision calibration location is taught. Do not edit this value.

Laser

Laser Enable: Select Enabled to allow use of the Laser Plane program command.

Laser Calibration Location X, Y, Z: The taught position (system coordinates) of the axes so the laser dot is positioned in the calibration dot.

NOTE: The Laser and Vision options both require a calibration dot. It is recommended that the same dot is used for both options to avoid confusion. However, a separate dot can be used for each device. See **Calibrate the Laser Option** on page 76.

Laser Calibration Height: The calculated distance based on the laser measurement when positioned over the calibration dot during the laser calibration process. A new reading is written to this field when the laser button is pressed. Do not edit this value.

NOTICE

The laser sensor requires a 30-minute warm-up time. Measurement values drift during this warm-up period. Running programs that require using or calibrating the laser during this warm-up time will result in inconsistent results and could cause machine or part damage. Under normal operating conditions, the laser sensor is always powered on unless the main power disconnect switch is turned off.

Barcode

NOTE: Barcode parameter requirements may vary by application and are subject to change based on each application's unique requirements.

Barcode Enable: Select Enabled to allow use of the barcode reader to select the part program.

NOTE: The Part in Fixture sensor must be enabled for the barcode feature to function properly.

Barcode Camera IP: The IP address for the barcode scanner. The default factory setting for this is 192 168 000 204.

Barcode Position X, Y, Z: The taught position (system coordinates) that the axes move to before the scanner is triggered to read a barcode. If a coordinate of 0, 0, 0 is entered, the axes stay in their current position when the barcode scanner is triggered.

Barcode Jump Rate: The speed at which the axes move to the barcode scan location when the barcode scanner is triggered.

Barcode Jump Height: The height to which the axes move to the barcode scan location when the barcode scanner is triggered.

Barcode Input: The motion controller input that triggers the barcode scanner is selected from a pull down menu. There are three options: Button, Slide, and External.

- **Button:** When the start button is pressed while a slide is locked in place, the scanner is triggered to read the barcode and select the correct program. The selected program automatically runs if a matching barcode is found on the barcode screen.
- **Slide:** When a slide is pushed in, the scanner is triggered to read the barcode and select the correct program for that slide. The selected program automatically runs if a matching barcode is found on the barcode screen. The Part In Fixture sensors must be enabled; the Part Load must be disabled. See the **General** parameters on page 23 and the **Part Load** parameters on page 28.
- **External:** When the machine is in the Run mode, the barcode scanner must be triggered by an external input device connected to the barcode scanner trigger input. When it is triggered, the scanner reads the barcode and selects the correct program. The machine does not automatically run the program. To run the selected program you need to press the start button or push in the left slide. The number of nests must be set to 1 and the Barcode Position X, Y, Z must be 0, 0, 0. See the **General** parameters on page 23. Refer to the wiring harness diagram and/or the wiring schematic in UniXact Automated Dispense Platform Parts manual 3A4061 for more details.

Valve Parameter Descriptions

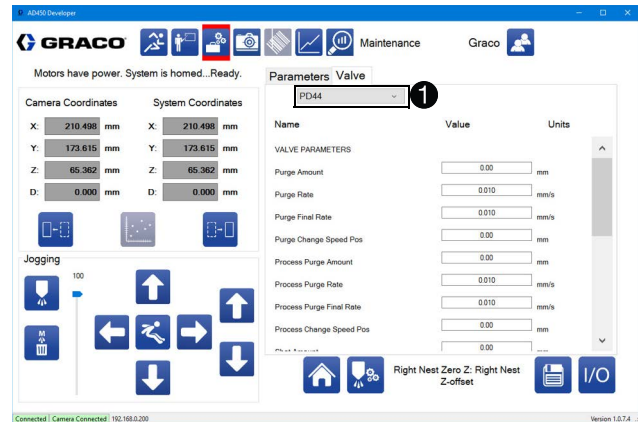

Select the Valve tab to access the valve parameters. Use the drop-down menu to select the type of valve in use for your system ①.

NOTE: Changing to a different valve populates the valve parameters with the defaults for that type of valve.

NOTE: See **Appendix E: Dispenser Integration** on page 99 for additional valve integration details.

Valve 710, Valve Endure, Valve MD2

These are On/Off Style Valves.

Purge Time: The amount of time the dispenser is on during a purge. This valve can be set to 0 to prevent the system from purging any material.

Process Purge Time: The amount of time the dispenser is on during a process purge. This valve can be set to 0 to prevent the system from purging any material.

Test Shot Time: The amount of time the dispenser is on while performing a test shot.

Valve PR70

NOTE: The PR70 two-component liquid dispensing system must have the Advanced Display Module (ADM) option.

Purge Shot: The shot number that is fired when the system triggers a purge.

Test Shot: The shot number that is fired when the system triggers a test shot.

Shot 1-15 Amount: These 15 parameters provide the labels associated with each of the 15 possible shots of the PR70 valve. The labels appear anywhere that a drop-down menu to select a shot appears. These values are for display purposes only and do not affect the PR70 valve functionality.

Valve 1053, Valve 1093, Valve PD44

These are Servo rod displacement with pneumatic spool inlet/outlet valves.

Purge Amount: The amount the dispenser moves during one shot of a standard purge.

Purge Rate: The initial rate at which the dispenser moves during a standard purge.

Purge Final Rate: The rate at which the dispenser moves during the last portion of a purge.

Purge Change Rate Pos: The point at which the dispenser moves during the last portion of a purge.

Process Purge Amount: The amount the dispenser moves during one shot of a process purge.

Process Purge Rate: The initial rate at which the dispenser moves during a process purge.

Process Purge Final Rate: The rate at which the dispenser moves during the last portion of a process purge.

Process Change Rate Pos: The point during a process purge at which the dispenser switches from moving at the process purge rate to moving at the process purge final rate.

With Snuff Back: The dispense valve can be reversed after dispensing to retract (negative dispense) material in the pump to reduce pressure and dripping or oozing at the dispense tip.

Snuff Bank Volume: The volume of material in cubic centimeters (cc) that is drawn back into the dispense valve at the end of each dispense.

Snuff Back Rate: The rate in cc/min that the pump runs after each dispense is complete.

Shot Amount: The distance the dispenser moves to dispense a test shot (if applicable for the current valve).

Shot Rate: The speed at which the dispenser moves when dispensing a test shot (if applicable for the current valve).

Dispenser Reload Rate: The speed at which the dispenser on the valve moves to reload during normal operations or purging.

Dispense Homing Rate: The speed at which the system moves the dispense valve during homing.

Dispense Jogging Rate: The default speed at which the system moves the dispense axis during jogging.

Stroke Length: The maximum distance the dispense valve metering rods can travel.

Pitch: The pitch of the lead screw within the dispense valve.

Diameter (Lo): The diameter of the valves low volume metering rod. This side is typically labeled B.

Diameter (Hi): The diameter of the valves low volume metering rod. This side is typically labeled A. (Not available for 1053 and 1093 valves.)

Max Rate: The maximum speed at which the dispenser's metering rod can travel.

Volume/Rev: The volume dispensed per revolution of the dispenser. This is a derived parameter and cannot be set.

Valve PCP (Progressive Cavity Pump)

The PCP valve is a continuous flow rotary pump. Pump output is specified in cc per revolution (rev).

NOTE: To avoid damaging the pump and to ensure proper loading with material, the maximum revolutions per minute (RPM) of the pump must be limited. Applying motor gear reduction allows more precise control of the pump speed at low RPMs.

Gear Box Ratio: Enter a value for gear reduction. For example, if a 15:1 reducer is used, enter 15.

Max Rate: The maximum dispense rate for the pump or the application. This value acts as a soft limit for pump speed that cannot be exceeded in a program.

Volume/Rev: The output per revolution of the pump in cc.

With Snuff Back: The dispense valve can be reversed after dispensing to retract (negative dispense) material in the pump to reduce pressure and dripping or oozing at the dispense tip.

Snuff Back Volume: The volume of material in cc that is drawn back into the dispense valve at the end of each dispense.

Snuff Back Rate: The rate in cc/min that the pump runs after each dispense is complete.

Shot Size Amount: The volume to be dispensed each time a test shot is initiated.

Shot Rate: The dispense rate in cc/min for the test shot.

Jog Rate: Future - no current function.

Purge Amount: The volume the progressive cavity pump dispenses during one shot of a standard purge. Volume is specified in cc.

Enable Depressurization: Depressurization is associated with the purge function. When enabling this feature, the material feed pressure must be manually turned to zero. When depressurization is enabled and a purge shot is triggered, the purge shot size will be ignored and the pump will dispense at the purge rate until the depressurization pressure is reached or 30 seconds has passed, whichever occurs first. The pump will then stop dispensing.

NOTE: Auto purge does not function normally when depressurization is enabled. The purge timer triggers a purge as described above. The purge timer does not reset when the purge is complete, so the automatic purge cycle will not continue.

Depressurization Pressure: The pressure at which the pump will stop purging during depressurization.

NOTE: The actual output of a progressive cavity pump may be less than the expected output based on the volume per revolution rating of the pump. This is known as "slip." The amount of slip increases as viscosity and RPMs increase. Pump slip increases pump wear.

PCF

Purge Time: The amount of time the dispenser is on during a purge. This valve can be set to 0 to prevent the system from purging any material.

Process Purge Time: The amount of time the dispenser is on during a process purge. This valve can be set to 0 to prevent the system from purging any material.

Test Shot Time: The amount of time the dispenser is on while performing a test shot.

Programming

Select the  icon to open the programming function.

NOTE: You do not need to be connected to the UniXact controller to create a program.

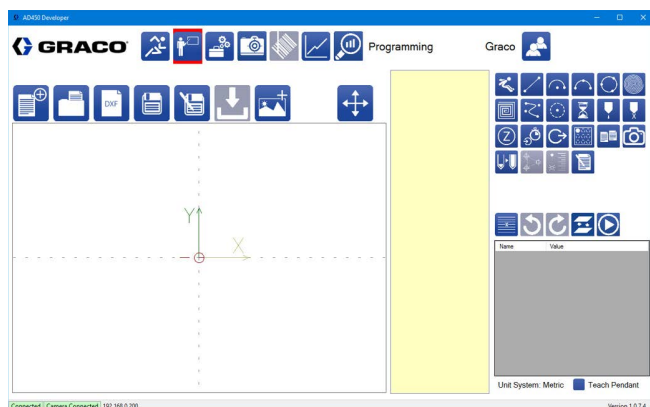

The Programming (Teach) screen allows you to create new programs for dispensing parts. Part programs can be saved to and loaded from a local or network drive. By default, the folder used for saving and loading programs is named Parts and it is in the same location as the executable file. The file path can be changed in the parameters. See **Manage the Parameters File** on page 22 for more information.

The following sections describe the functions available to create, edit, save, load, and download part programs. Here is some helpful information regarding the UniXact programming environment.

- Since the purpose of the program is to create parts, the part programs are sometimes referred to as parts in this manual, and are typically saved with names of parts.
- The Programming screen is also referred to as the Teach screen. This is because as you are creating the program, you are teaching the machine to dispense based on the design you are programming.
- Saving the program does not make it ready to run. It simply means that you are saving the file to the appropriate folder. The file must be downloaded before it can be run because downloading the program compiles it.

- If you edit a saved program (or sub-routine within a saved program), you will need to recompile (download) that program for it to accept the changes. Changing and saving a program does not change the compiled program.

The Tool Path

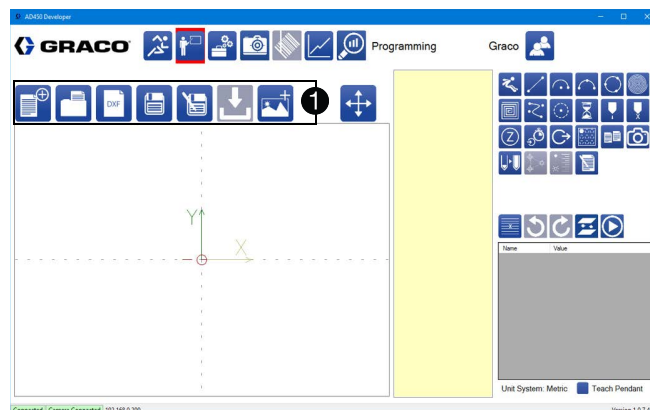

The location of the tool path on the screen is shown above ①. The tool path includes icons for saving, loading, and downloading part programs. The name of the current program is displayed above the tool path. If the current program does not yet have a name, this field is blank.

On the first save, you are prompted to name the program. The file location for the program to be saved/loaded is configured in the parameters. See **Manage the Parameters File** on page 22 for more information.

NOTE: Programs do not save automatically. Opening a program or starting a new one without saving will undo changes made to the program that is currently open.



New Part: Select this to start programming a new part. A confirmation appears when you select this option. You need to name the program the first time you save it.



Open Part: This opens a previously saved part program. When you select this icon, choose a part from the pop up window.



Save Part: Select to save the current part program under its current name. If the current program does not have a name, enter a part name for it when prompted.



Save Part As: Select to save the current part program under a different name. Any additional changes to the program are then made under the new name. The program for the original part name is not affected.



DXF Import: You can select a DXF file from any location, select the appropriate layer of the DXF file, and have that layer converted into a part that follows the lines in that layer. See **Using DXF Files** on page 50 for information about this tool.



Download: This downloads the current program to the controller. The program is compiled prior to the download. Part programs in the controller can also be deleted. A maximum of 20 programs can be stored in the controller, after which new ones cannot be downloaded.



Add Picture: This links a picture of the part for viewing on the Operation screen. The picture displays to the right of the Active Program. Pictures can be in either JPG or PDF format and are linked to the part by the file path. Moving a picture or changing the name breaks the link, which would cause the picture not to display. A missing picture does not affect the functionality of the program.

NOTE: When a part program is downloaded, the selected valve data, the selected program, and any included subroutine data is compiled into a single program for the motion controller. If there is a valve change, the program needs to be recompiled or an error message will appear to alert the operator to compile (download) the part program again. If a program is used as a subroutine, the changes to the subroutine are not applied to any part program that references it unless the top-level part program is recompiled.

Loading a Part Program

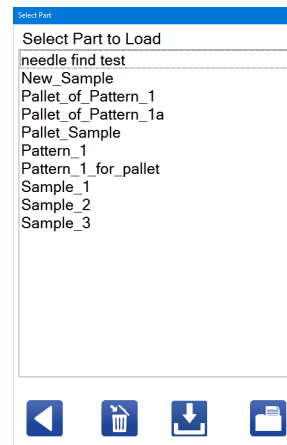

Select the  icon to load a part program. The list consists of all parts stored in the file path defined in the parameters screen.

Part programs can also be deleted or downloaded to the machine's controller from this pop up window.

NOTE: If you currently have a program open, it must be saved prior to opening a new one.



Back: Close the window without loading a part program. Any other changes made (programs deleted or downloaded) are retained.



Delete: Delete the selected part program from the computer. While this permanently removes the part from the computer (and the selection from the parts list) it does not remove the part program from the machine's controller.





Download: Download the selected part program(s) to the machine's controller. Multiple parts can be downloaded simultaneously, but if the maximum number of part programs in the controller is exceeded, you are prompted to download only some of the selected parts.

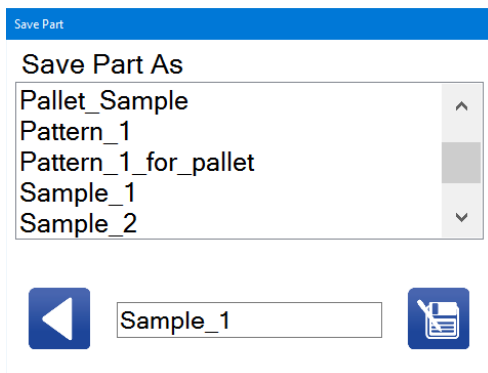

Open: Load the selected part program onto the programming screen. Any previously opened program is removed from the screen.

Saving a Part Program



The first time you save a part program you are creating, select the  icon to open the Save Part window. Once you have saved the part the first time, if you want to save it under another file name, select the  icon to open the Save Part window.

The Save Part window lists all existing part programs. Enter the new name into the field at the bottom of the window between the two icons. Part names must contain only alphanumeric characters and underscores need to be used instead of spaces between words.



Back: Close the Save Part window without saving the program. The name for the part remains the same.



Save As: Save the current part program under the name you assigned it. You can overwrite previous programs by giving the new part program the same name. Keep it mind that the program being replaced is then lost.

NOTE: Once a part program has been saved the first time, it automatically saves when you press the Save icon and does not open the Save Part window unless you click the Save As icon.

Downloading a Part Program

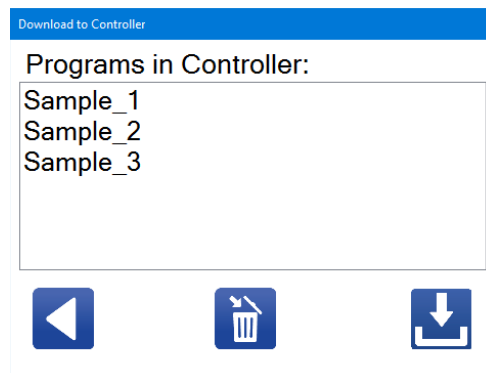

Select the  icon from the Tool Path to open the Download to Controller window. This window lists part programs currently in the machine's controller. You can choose to delete existing part programs or download and compile the current program.

NOTE: If the maximum number of part programs in the controller has been reached, a message informs you of that and the program is not downloaded. Part programs cannot be overwritten.



Back: Close the Download to Controller window without downloading a part. Part programs deleted from the controller are not restored.



Delete: Delete a selected part program from the machine's controller. A maximum of 20 part programs can be stored in the controller simultaneously. Deleting old part programs may be necessary to make room for new ones in the controller.



Download: Download and compile the program currently open on the programming screen. When attempting to start the download, you are informed if the maximum number of part programs in the controller has been reached. Programs cannot be downloaded unless they have been saved first.

Any changes made to the program are not automatically downloaded. You need to download the part program again.

Viewing Part Programs

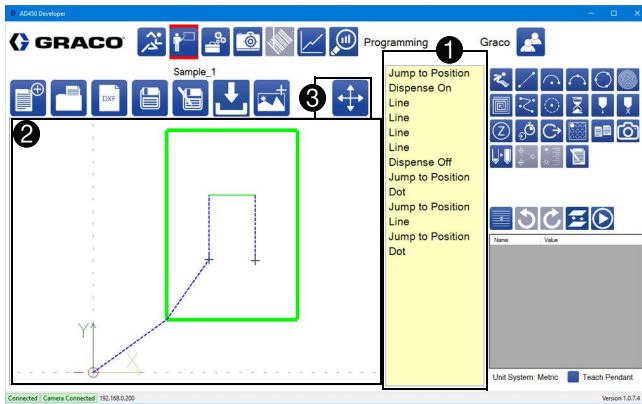

Each part consists of a list of program commands displayed in a single column ①. You can enter, view, or edit the parameters of the commands.

The part display ② shows the lines and the motions the system takes when the program is executed on the machine.



- A blue dotted line indicates a rapid move.
- A solid line indicates a regular motion, with the line color indicating the relative speed; red speeds are slower and green speeds are faster.
- A gray plus indicates a spot dispense.
- An orange square indicates a pause.
- An orange triangle indicates waiting for an input.
- A purple triangle indicates waiting for an output.

NOTE: Lines and symbols are thicker where the program indicates that the dispenser is on while they are being performed.

When using the touch screen, double tap the display to automatically center the part and zoom it to fit the window. Press and hold it to provide options for the angle at which to view the part. Touch the display with two fingers and either pinch the fingers together or expand them apart to zoom the view to be larger or smaller.



Part Movement/Rotation: Toggles the mouse or touch controls for manipulating the part position in the display ③.

Select the  icon to pan the part left/right and up/down by touching a point and dragging to move the part view. Select the  icon to touch a point on the display and drag it to rotate the part around its origin.

Programming Commands

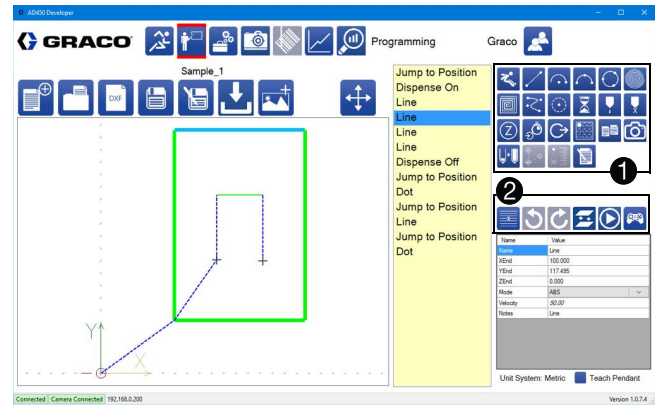

The group of icons in the upper-right portion of the Programming screen are the commands that you can use in a program ①.

The icons immediately below the group of programming commands are for making edits and updates to the program ②.

All commands include a notes field for reference. Parts also include a name field that defines how the part is displayed in the command list. The name and notes fields do not impact the motion program. You can:

- Select an icon to add that command to the end of a program.
- Select and drag an icon to drop that command into the middle of the command list.
- Select a command within the program and drag it from one position to another within the program.

Available Commands



Jump to Position: Moves the dispenser to the endpoint specified by first moving in the Z direction up to a specified height, then moving in the X and/or Y directions as necessary, and then moving down in Z to the final point. Move velocity is set in the Rapid Speed setting of this command. The maximum speed allowed is limited by the Rapid Speed settings in the parameters.



Line: Moves in a straight line to the designated endpoint. This move occurs at the designated velocity.



Arc: Moves in an arc of specified radius to the designated endpoint. Arcs must be 180 degrees or less. They cannot encompass a full circle or greater. You must specify if the arc is to be clockwise or counterclockwise. This move occurs at the specified velocity.



Three Point Arc: Moves in an arc through a specified point to the designated endpoint. Arcs cannot encompass a full circle or greater. Specify if the arc is to be clockwise or counterclockwise. This move occurs at the specified velocity. If programming in incremental mode, both the arc point and the end point are located with respect to the start point.



Circle: The system moves in a circle composed of up to 3 segments. No Dispense On command is required; it is included in segment 2. See **Circle Segments** on page 42 for more information about the Circle command.



Spiral Fill: The system moves in an increasing outward spiral or decreasing inward spiral. The spacing (pitch) between lines of the spiral can be set to approximately match the bead width and achieve complete fill. The software automatically adjusts the pitch so there is the same number of beads to the left and to the right of the center of the spiral. A spiral fill is located by teaching a start and end point of the spiral. One of these points is located on the outside diameter of the spiral and the other is located in the center of the spiral. The spiral type (inward or outward) should be selected before teaching the start and end points. Positioning of the spiral changes if the type is changed after the points are taught.

NOTE: A spiral fill does not follow an inclined plane based on the defined start and end points of the spiral. The Z height for both the start and end points must be equal for a flat fill pattern to be dispensed.



Rectangular Fill: The system moves in an increasing outward rectangular spiral or decreasing inward spiral. The spacing (pitch) between lines of the rectangular spiral can be set to approximately match the bead width and achieve complete fill. The software automatically adjusts the pitch so there is the same number of beads to the left and to the right of the center of the spiral. A rectangular fill is located by teaching three corner points of the area to be filled.



Spline: The system generates a continuous smoothly curved dispense path that attempts to go through a series of taught points. When there are only a few defining points taught or the sequence of points contains sharp transitions that do not form a smooth curve, a spline may be generated where the path does not pass through all of the points. Spline accuracy can be improved by adding more points, especially in areas where there are sharp transitions in direction. The spline is a 2D function and should be programmed with a constant Z height dimension.



Dot Dispense: Turns on the dispenser at the specified rate for a specified amount of time. This command is indicated in the display by a gray plus sign.



Time Delay: Pauses the system for the specified amount of time before continuing.



Dispense On: Turns on the dispenser at the specified rate. The dispenser remains on until the system is commanded to turn off the dispenser. Commands that occur while the dispenser is running have thicker lines in the display. The delay setting creates a pause after dispense begins and before the next command is executed.



Dispense Off: Turns off the dispenser.



Rapid Z: Moves up in a straight line to a specified height on the Z axis. See **Running** parameters on page 24 for the Rate parameters for this move.



Wait for Input: Wait until a specified input has been received. The desired state of the input can be selected to be either on or off. A timeout value is included, but can be set to zero to disable the timeout.



Set Output: Set the specified output state to either on or off.



Palletize: Load an existing program and place it in a pallet (rectangular array) so that the same pattern can be repeated multiple times. You can specify the spacing and the number of rows and columns in the command properties. For additional information, refer to **Using the Palletize Command** on page 42. An example of the palletize command is provided in **Appendix B: Palletize Example** on page 94.



Subroutine: Load an existing program as a subroutine of the current one. The subroutine is not offset unless it is comprised of incremental movements. Changes made to the source program are carried over. A subroutine is skipped if it references its own program or if the required state of the selected input address is not met.



Vision: Move the axes to locate fiducials. When enabled, rotation and offset parameters are applied to position the dispense pattern based on the location of the fiducials instead of the taught locations. This function allows you to match the taught position of the original “standard” part that is used for machine calibration even if a part has slight variations or is positioned differently in the slide. See **Using the Vision Command** on page 42 and **Calibrate the Vision Option** on page 74.



Reload: Triggers a servo-driven valve to reload at the defined reload speed. Without this command, the requested shots are dispensed in sequence and reload only occurs after the part is complete. The Reload command is necessary if the volume being dispensed on a part exceeds the maximum single shot dispense capacity of the valve. The Reload command should always follow an End Dispense command in a program.

NOTE: This command can cause a pause in motion. Reload takes place simultaneously with non-dispense moves, but continues until reload is complete. This means that the motion may pause before the next dispense begins if the motion time between dispenses is less than the move time. The pause can be eliminated by adjusting move velocity and reload velocity to make the motion time longer than the reload time. Reload does not occur during the lead out portion of a circle.



Laser Plane: Used to teach the pitch, roll, and Z height of a part surface (plane) by reading the precise Z height at three defined locations on the plane. Z adjustments are then applied to adjust the z=zero plane to match the plane orientation of the part used to teach the perfect part. When a program is run, adjustments are applied to all of the commands following the Laser Plane command and remain in effect until the end of the program or until the program is aborted. Any program commands that need to be run on an unadjusted plane must be placed before the laser plane command. See **Laser Plane Application Notes** on page 45 for more information.



Comment: Add a comment to the program to explain program operation. The Name field can be edited to appear in the command list. The Notes field can be edited to include more extensive notes that are viewable when you open up the comment command. Comments are not executed; they are skipped over when the program runs.

Program Editing and Updating



Delete Line: Deletes a command from the program. Select the command, and then press this icon.



Undo: Undo changes you have made to the program in reverse sequential order. One change is undone each time this icon is pressed. You can only undo changes up to the last time the program was saved.



Redo: Redo changes to the program that were undone. One change is redone each time this icon is pressed. You can only redo changes up to the last time the program was saved.

Global Z Offset: Changes all the Z coordinates in a program by adding or subtracting the offset value. Jump heights and programs called with a subroutine are not affected.



NOTE: Using this command in programs containing a Laser Plane command or Vision command is not recommended because it changes the calibration. If it is necessary to use the Global Z Offset in a program with Laser Plane or Vision commands, the commands must be deleted and re-taught after the Global Z Offset is applied.



Start Program Here: Changes the start point of a program. When you select this icon, the command in the program that is currently highlighted becomes the first command in the program. That command and all the following ones are moved to the top of the program list. All commands above the selected command are moved to the bottom of the program list. For more information, see **Changing the Start Point of a Program** on page 45.



Jog Screen: Opens the jog screen to allow teaching the endpoint for a selected command. This button is only visible if the selected command has a specified endpoint.

Circle Segments

A circle is comprised of three segments.

Segment 1 is a dry (no dispense) lead-in that moves the specified degrees of rotation and indexes the Z axis down or up to drag out any drip that may be on the needle. Set the degrees to zero to disable the dispense or to continue the dispense from the previous segment.

Segment 2 is a circle dispense that starts the dispensing, moves the specified degrees of rotation while dispensing, and stops dispensing at the end of the segment.

Segment 3 is a dry run lead-out that moves the specified degrees of rotation and indexes the Z up or down to drag out any material and overlap as the dispense tip de-pressurizes. Enter a zero to disable this segment or to continue dispensing another segment after the circle command.

Using the Palletize Command

The following command sequence shows a typical application of the Palletize command.

1. Wait For Input
 2. Jump To Position
 3. Jump To Position
 4. Palletize
 5. Jump To Position
1. Wait for an input from the start device. If dual-Y slides are used, this step is not necessary.
 2. Jump to the part present position if the part present sensor feature is enabled and being used to detect a pallet of parts. If a pallet is present, the program runs; if not, the program aborts.
 3. A Jump to Position command is used to locate the first part in the pallet in the X, Y, and Z planes. This point is the origin (0,0,0) of the first part and the pallet. X and Y offsets are applied from this point as defined in the Palletize command to locate the origins for the remaining parts in the pallet. The Z is the same for all parts in the pallet and is established by this Jump to Position command. The palletized program should be written so that the origin is the start point of the dispense pattern because the dispense tip always indexes to the origin at the beginning of each part.

If a part is not specified in the Palletize command, the dispense tip indexes to the start location (origin or 0,0,0) of each part in the pallet. When a part program is added, it runs as though the first command in the part program is jump to 0,0,0. If the start point of the part program is not 0,0,0, there is an extra jump at the beginning of each part.

4. The Palletize command repeats the specified part program in the specified number of columns and rows. If an input address is specified, the required state of that input address is evaluated at the beginning of each part in the pallet. If the condition is true, that part in the pallet runs, If the condition is false, that part in the pallet is skipped.
5. Jump to a position that allows the part to be removed without interference. If the part Load/Unload feature is enabled, this command is not necessary.

For more information about programming a pallet part, refer to **Appendix B: Palletize Example** on page 94.

Using the Vision Command

The Vision Command is used to teach fiducials. Fiducials are unique features of a part that are used as points of reference by the machine to positively identify the part orientation to ensure accurate dispensing. Two fiducials must be taught. They will show in the list of commands in the program as Vision 2.

NOTE: The Vision command can only be used in a top-level program. This command does not function in a program that is called to run from a subroutine or palletize command.

NOTE: It is imperative that the same part orientation that is used to teach the fiducials is also used to teach the part pattern. Do not remove or reposition the part in the nest between these steps. This establishes the relationship between the dispense pattern and the fiducial.

NOTE: Since developing a dispense pattern that is acceptable for production can require repeated dispensing of numerous parts, it is recommended that the pattern development work be done before adding the Vision command. When a production-ready part is run that can be used as the standard for a good part, teach the Vision command before removing the part from the nest.

1. Select  from the programming icons on the right side of the Programming screen to open the Vision window.
2. Select the Start button above the live camera view to begin. Instructions, each with a Continue button to advance to the next instruction, replace the Start button. Perform each task as instructed.

Start Button Prompts Shown Here

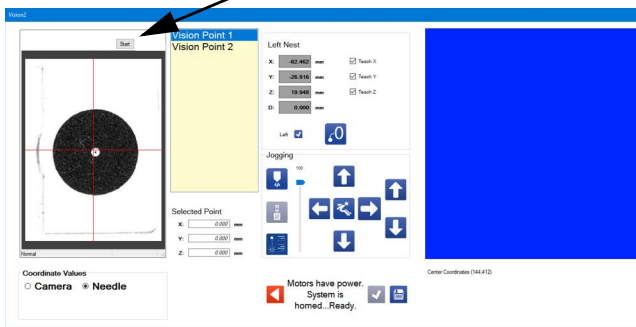

NOTE: Some versions of software may request that you set the camera exposure first. This is for factory use only. Do not make adjustments to the camera lens. Just select Continue to advance to the next step.

5. Use the jogging tool's up and down arrows to focus the fiducial. Once you have a clear picture of the fiducial, select Continue.
6. The blue rectangle in the window is for outlining the perimeter of the fiducial. Reposition and resize the outline box using the drag tools to stretch, bend, or rotate it until the box surrounds the fiducial. The rectangle turns red when you select it to make adjustments.

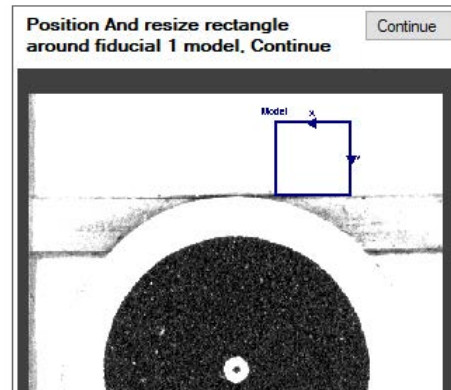

NOTE: Anything outside the outline box is not taught as part of the fiducial so make sure the entire fiducial is inside the box.

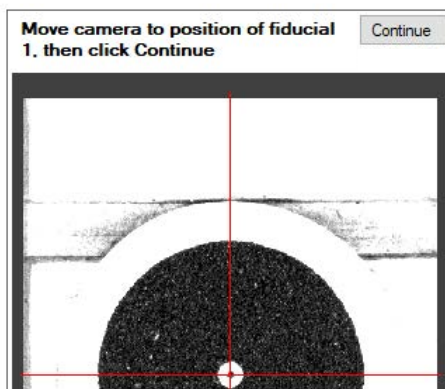

3. Move the axes so the desired fiducial is in view. While it is advisable to center it as much as possible, it does not have to be perfectly centered to perform these steps.
4. Below the Vision Window, leave Needle selected. Do not select Camera.

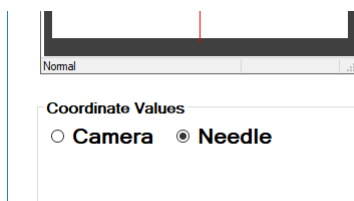

7. Select Continue to proceed.

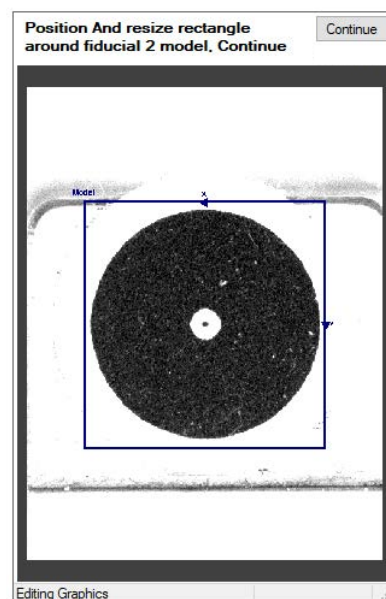

8. A message appears if the teaching was successful.

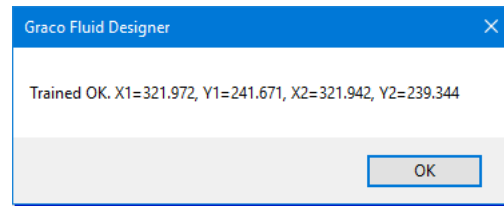
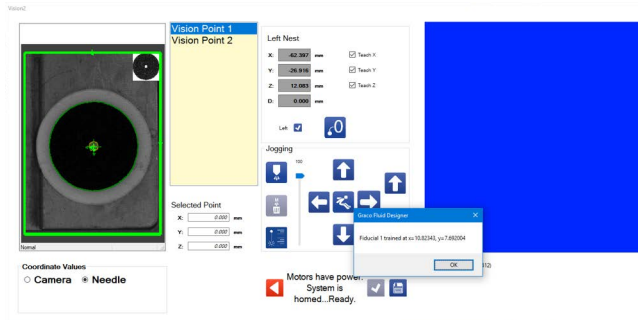

9. Examine the fiducial view to determine if the desired features are highlighted and if the highlighted features are present and repeatable on every part. The following color indicators show the level of success.

Color	Description
Green	Indicates a feature taught with high confidence
Yellow	Indicates a feature taught with moderate confidence
Red	Indicates a feature taught with low confidence

10. If the training fails or is unsatisfactory, delete the command and perform one of the following actions:

- Reteach the current fiducial.
- Consider an alternative fiducial.
- Adjust the camera parameters.
- Adjust the camera lens, which requires recalibration. See **Calibrate the Vision Option** on page 74.
- Consider making lighting adjustments.

11. Select OK if the teaching was successful.

12. Repeat steps 3 - 11 to teach fiducial 2.

13. When both fiducials (Vision Point 1 and 2) have been taught, a second message appears confirming completion. Select OK to complete and save the command.

14. Teach the remainder of the program to be located precisely on the currently nested part.

Vision Command Notes

Do not move the camera position (axes) when programming fiducials unless you are instructed to do so in the command prompts.

Adjustments are applied to the current part on all commands following the Vision command in your program.

The same camera lens adjustment must be used to calibrate the camera and teach the Vision command.

The camera identifies the fiducial as light to dark transitions (contrast). If you see contrast in the camera window, it will be part of the fiducial. Use the outline box to include or exclude features. See step 3 in **Using the Vision Command** on page 42.

Light to dark transitions can be the result of contrasting color or the result of part topography and lighting (shadows). Light to dark transitions also can be enhanced or minimized by camera aperture settings (grid).

Camera settings are the same for both fiducials within the same command.

All camera commands in the part program as well as the camera calibration need to be updated (reprogrammed) when the positional relationship between the camera, the dispense needle, and the calibration dot is changed. The following actions change the positional relationship.

- Adjusting the focus with the camera lens.
- Adjusting the aperture with the camera lens.
- Changing the needle find position.
- Changing the position of the dispense tip (if it requires the needle find to be moved).
- Changing the calibration circle position.
- Repositioning or moving the camera.
- Repositioning a part fixture or placement of the part in the fixture.

Laser Plane Application Notes

The Laser Plane can only be used in a top level program. This command does not function in a program that is called to run from a subroutine or palletize command.

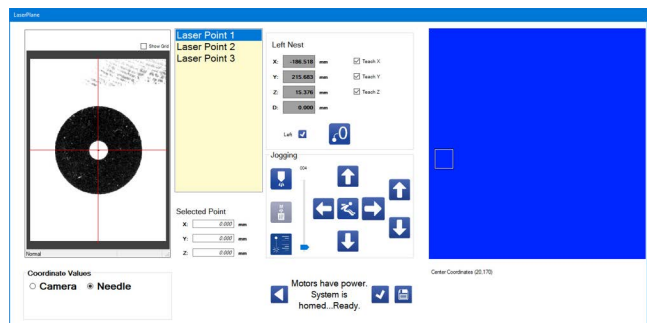

The Laser Plane feature, which is used to teach the pitch, roll, and Z height of a flat part surface (plane), requires installing the optional laser sensor.

It is important to verify laser calibration prior to beginning a program that uses this command. See **Calibrate the Laser Option** on page 76. The laser only measures distances between 75 and 130 mm above the part surface. If an error message appears when attempting to measure a teach point, it may be necessary to adjust the Z height. Surface characteristics of the part can affect this range.

The Laser Plane feature is effective in making small pitch and roll adjustments to perfectly flat planar part surfaces. This feature is less effective if the plane being measured and adjusted is not flat, such as slightly uneven or warped.

The laser sensor digital display located inside the control panel displays a measured distance. See **Calibrate the Laser Option** on page 76.

Displayed Distance	Description
-30	With the sensor approximately 130 mm from the target.
0	With the sensor approximately 100 mm from the target.
25	With the sensor approximately 75 mm from the target.
----	Indicates the sensor is out of range.

For best results, calibration and laser command measurements should be taken within 5-10 mm of zero. This allows any height variation between parts to be within range of the laser.

All laser commands in the part program as well as the laser calibration need to be updated (reprogrammed) when the positional relationship between the laser, the dispense needle, and the calibration dot is changed. The following actions change the positional relationship.

- Changing the needle find position.
- Changing the calibration circle position.
- Repositioning the laser sensor.
- Repositioning a part fixture or placement of the part in the fixture.

Changing the Start Point of a Program

For most program commands, the end point of one command is the start point of the next command. When you want to change the start point of a program, select the command where you want the program to start and

then select the  icon. When you do, a new Jump to Position (JTP) command is created and inserted immediately before the selected command and the program is reordered.

The inserted JTP command is the first one in the program and the command you selected is second followed by all the commands originally below the one you selected. The commands that were above the new start point command are now at the end of the program.

NOTE: The Jump to Position command is added to preserve the start point of the selected command. If you select a JTP command as the new starting point, the extra JTP command is still inserted. You need to delete the extra Jump to Position command for your program to run effectively. If the reordering causes a Jump to Position command to be at the end of the program, you should delete that JTP command, but test run the program to confirm first.

Command Properties

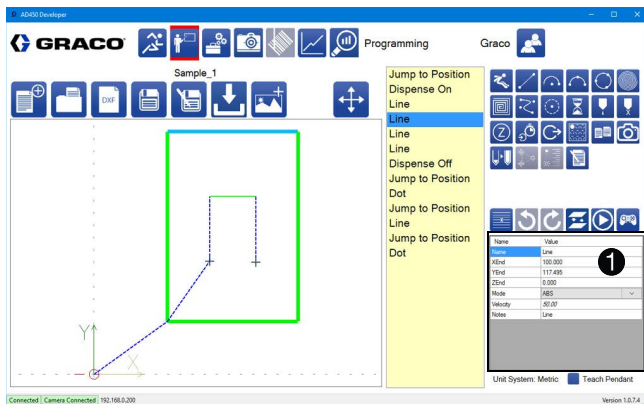

Each command has a set of properties that define it. The properties pane is located in the lower-right corner of the programming screen **1**. When a new command is selected from the part list, the list of properties is updated to reflect the new command.

Values for command properties that are coordinates can be taught using the jog window or teach pendant. All values for command properties can be edited by highlighting the property and manually entering a value.

The first command in a program must define where the pattern starts (usually a Jump To Position statement). The default starting point is the 0,0,0 point for the nest if there is no defining command.

The command properties pane shows the properties for the selected command that can be edited. The type of the command is shown in the Name and Notes field. You can change either of these fields to reflect something more meaningful to the programmer.

Command parameters can be taught or manually entered. Math functions are applied to numeric values to simplify editing. For example, to subtract 3 from a parameter, enter "--3" in the value field and select Enter (or click on another field). As shown in this example, the subtract function "-" needs to be entered twice to differentiate between entering a negative value and entering a math function. Valid math functions are:

- + for add
- for subtract
- * for multiply
- / for divide

Here are descriptions of available command properties.

ArcPointX, ArcPointY, ArcPointZ: The coordinates in X, Y, and Z that describe the point through which an arc should move for the three-point-arc. This provides the third point of the three-point-arc, with the other two points being the start point and the endpoint.

ArcPointX1, ArcPointY1: In a circle command, the X and Y coordinates of the first of the two points on the circle that define the circle. There is no Z coordinate because the Z coordinate of the circle is determined by the ZStart and LeadInDeltaZ values.

ArcPointX2, ArcPointY2: In a circle command, the X and Y coordinates of the second of the two points on the circle that define the circle. There is no Z coordinate because the Z coordinate of the circle is determined by the ZStart and LeadInDeltaZ values.

CircleVelocity: In a circle command, the speed to travel at during the main arc of the circle.

Columns: The number of columns in which to place a palletized part. Palletized parts cannot have more than 30 columns. If the number of columns is zero, no instances of the palletized part occurs.

DegreesOfCircle: In a circle command, the number of degrees to encompass during the main arc of the circle.

InputAddress: The input address to reference when waiting for an input. These options use the I/O labels specified on the Maintenance screen. Changing the I/O labels does not impact the program functionality. See **Manage Inputs and Outputs** on page 18. In a subroutine or pallet, the InputAddress value corresponds to the input checked when determining whether or not to run the subroutine or pallet (also see RequiredState).

JumpHeight: The height to which the system moves for a jump command. This is the height moved to during the initial motion and the height of the system while moving in X and Y. In incremental mode, the JumpHeight parameter is offset from the Z starting location.

LeadInDegrees: In a circle command, the number of degrees that the lead-in portion of the circle should encompass. A zero value disables the circle lead-in.

LeadInDeltaZ: In a circle command, the difference in Z between the start of the lead-in and the end of the lead-in. The Z value at the end of the lead-in is the Z value for the main portion of the circle. This is always an incremental move.

LeadInVelocity: In a circle command, the velocity to move during the lead-in portion of the circle.

LeadOut Degrees: In a circle command, the number of degrees to encompass during the lead-out. A zero value disables the circle lead-out.

LeadOutDispense: In a circle command, whether or not to turn off the dispense immediately before starting the lead-out motion.

LeadOutDeltaZ: In a circle command, the difference in Z between the start of the lead-out and the end of the lead-out. The Z value at the end of the lead-out is the Z value for the main portion of the circle. This is always an incremental move.

LeadOutVelocity: In a circle command, the velocity to move during the lead-out portion of the circle.

Mode: The mode for the system to process the endpoints. If the move mode is absolute (ABS), the system moves to the location specified by XEnd, YEnd, and ZEnd. If the move mode is incremental (INC), the system offsets its current location by the specified XEnd, YEnd, and ZEnd.

Name: The name of the selected command. All commands have a default name describing them (line, arc, etc.) that can be modified. A name change does not affect the type or how the program is processed.

Note: A field to include notes about a specific command. This field does not affect the motion program.

OutputAddress: The output address to reference for turning an output on or off. This uses the I/O labels specified on the Maintenance screen. However, changing the I/O labels does not impact the program functionality. See **Manage Inputs and Outputs** on page 18.

Part: The part to reference for the Palletize and Subroutine commands. Parts cannot reference themselves, either directly or indirectly.

- Any commands with a circular part reference are ignored.

- Any changes made to the referenced part is included when the top-level part is reloaded.
- Parts referenced through the Palletize command are offset based on the starting point of the Palletize command.
- Parts referenced through a subroutine command are not offset from their original location unless all commands are set to incremental mode.

Pitch: The spacing between each subsequent line of a spiral or square spiral. The pitch must be a divisor of the distance between the start point and endpoint. The pitch automatically sets to whatever divisor is closest to the entered value.

Radius: The radius of an arc for the arc command. If the radius is less than half the distance between the previous location and the location described by XEnd, YEnd, and ZEnd, this command does not function properly.

RapidSpeed: The rate at which the system moves for a rapid move (Jump and RapidZ). This value must be greater than zero. The maximum speed is limited by the Rapid Rate setting in the parameters.

Rate: The speed at which the dispenser displaces material during dispensing. The value must be greater than zero. The units for this parameter vary depending on the valve type. The rate for the 1053, 1093, and PD44 is measured in mm/s, indicating the velocity at which the dispense rods move. The PCP rate is shown in cc/min, which is calculated based on pump size and rpm. (The actual output rate is application dependent.)

RequiredState: For a subroutine or pallet, the state in which the associated input must be for the subroutine or Palletize command to run. This value can be set to On, Off, or None. If it is set to None, the subroutine or pallet occurs regardless of the state of the input. In a subroutine, the subroutine does not occur if the input is not in the correct state. In a pallet, the system jumps to the start position of each index of the pallet before checking the input. If the input is not in the correct state, it moves to the next input. The system may perform a jump to the final position of a skipped subroutine or pallet.

RotationalDirection: The motion for an arc command to move either clockwise or counterclockwise.

Rows: The number of rows in which to place a palletized part. Palletized parts cannot have more than 30 rows. If the number of rows is zero, no instances of the palletized part occurs.

ShotNumber: The shot number to fire when a Dispense On or Dot Dispense command is triggered if the system valve is a PR70 valve. The parameters associated with each shot number must be set in the PR70 valve. The parameter is not applicable for all valve types.

SpiralDirection: The direction in a Spiral Fill or Rectangular Fill command as either inwards from the start point to the endpoint or as outwards.

State: The desired state for an input or an output. The state can be On or Off. Inputs wait for the indicated state, while outputs are set to that state.

Time: The time a command should wait before proceeding to the next command. In the Dot Dispense command, this property specifies how long the dispensing should occur. This value must be greater than zero.

TimeOut: The amount of time to wait in a Wait for Input command before the program times out, aborts the program, and releases the slide (if applicable). A zero value causes an indefinite wait, which would result in you having to press the abort button if an input is not received.

Velocity: The speed at which the system travels for the current move. The maximum velocity the system moves is limited by the running rate set in the parameters. This value must be greater than zero.

XEnd, YEnd, ZEnd: The coordinates in the X, Y, and Z axis for the endpoint of the current move.

XStart, YStart, ZStart: The coordinates in X, Y, and Z where the circle starts in a circle command. These values inherit the end values of the previous command if not specified. If the values are specified and distinct from the endpoint of the previous command, a jump to position is added from the end of the previous command to the start of the circle. The start coordinate for other commands (except circle or fill commands) is the endpoint of the preceding command and does not appear as a X/Y/ZStart in the parameters list.

XSpacing, YSpacing: The spacing in X and Y between the starting points for each instance of a palletized part. If XSpacing and YSpacing are both set to zero, the palletized part motions are repeatedly performed in the same location.

ZUpSpeed: In jump commands, the speed to move during the first portion of the jump to the designated jump height. If this value is not specified, the Rapid Rate value for the command is used.

Vision Command Properties

Patient Zero X1, X2, Y1, Y2: Calculated location parameters for the part used to teach the Vision command (patient zero). Do not edit these values.

X, Y, Z End... End 2: Two taught coordinates identifying the position of the fiducials on the patient zero part. See **Using the Vision Command** on page 42 and **Calibrate the Vision Option** on page 74.

Laser Plane Command Properties

X, Y, Z End... End 2... End 3: Three taught coordinates that define the slope of the part plane on the patient zero part. These points can be selected from any flat/planar surface on the part. Pitch and roll calculations are applied to adjust the X-Y coordinate system to be parallel with the laser plane.

Using this feature to adjust the surfaces that are not planar may yield unsatisfactory results especially if the teach points define a large plane with a large area.

Laser Shot, Laser Shot 2... 3: This is a calculated height measurement value that is populated when each of the corresponding "End..." parameters is taught. Do not edit these values.

Inherited Command Properties

Some commands have properties that can be inherited from a previous command and/or passed on to the next command. An inherited value is displayed in italics in the value window next to the property. Command properties that can be inherited are:

- Velocity
- X position coordinate
- Y position coordinate
- Z position coordinate

Breaking Inheritance: Inheritance from the previous command is broken by manually entering a value. When this is done, the value no longer appears in italics. All values of the command property following this change will inherit from the newly entered value.

Restoring Inheritance: Inheritance can be restored by clearing the value field so no value is shown, and then selecting Enter. The value appears in italics as long as there is a previous command to establish a value. The first value of any command property with inheritance does not appear in italics since this is where the value to be inherited on following commands is established.

- Dispense On commands must have a corresponding Dispense Off unless the system valve turns itself off automatically (such as the PR70). The Dispense Off in a circle command can accomplish this.

Invalid Commands

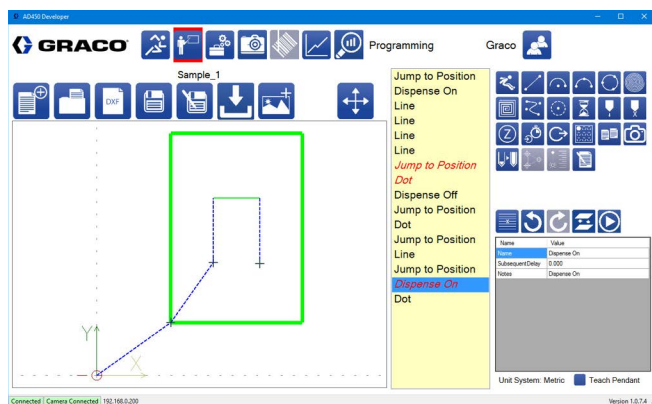

Commands that are invalid are displayed in *red italics* in the program list. Commands are invalid if any of the following conditions are violated:

- Commands requiring motion, such as lines and arcs, must have a positive velocity or rapid-speed.
- The referenced program for the Subroutine and Palletize commands must exist.
- A three point arc must have 3 distinct points.
- Circle commands must have 3 distinct points and must move a total of more than zero degrees. Any portion of a circle (lead-in, main circle, lead-out) that is moving more than zero degrees must have a positive velocity. If a circle command turns on a dispense, it must either turn off the dispense or have a command to turn off the dispense occur later in the program.
- Any value attempting to turn on the valve must have a positive rate for the valve.
- Dot Dispense commands must have a time value greater than zero if applicable for the system valve.

If any invalid commands are present, you will be unable to download the program to the controller. When attempting to download to the controller, a message shows the list of commands that are invalid.

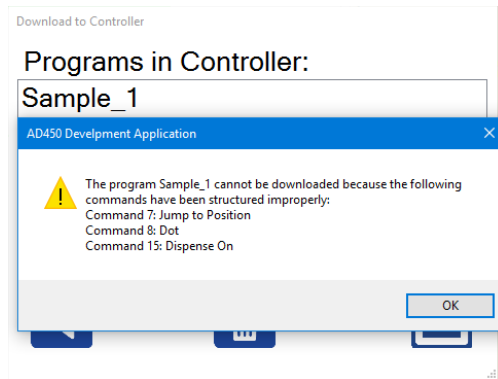

Using DXF Files

This feature is intended for importing two-dimensional flat patterns.

DXF File Preparation

Cleaning up a source file before saving it in DXF format can minimize or eliminate the need to further manipulate the pattern in the UniXact software.

1. Change properties of all pattern lines to be on the same layer.
2. Make sure there are no other lines on the layer with your pattern. If so, they will be imported and need to be deleted.
3. If the file contains features in the source file such as polygons or polylines that treat multiple lines as one entity, they should be exploded so the entity is broken into individual segments.

NOTE: Some software creates a 3D DXF file that has non-zero Z coordinates. Be aware that some program commands do not interpolate in the Z axis and will not run as intended.

NOTE: Some segments of multi-line entities may not import.

NOTE: Importing ellipses is not supported. An ellipse can be closely approximated using 4 arc segments.

NOTE: Importing splines requires that a splined curve must not intersect with itself. It must be a single segment and cannot form an enclosed shape. For more information about splines, see **Spline Functions** on page 55.

4. Locate the pattern appropriately with respect to the origin (0,0,0) to match the fixture/part origin.
5. Creating a custom layer for the pattern to be imported from a DXF file may be beneficial and help avoid importing unwanted features that may not be viewable. Naming the layer “DXF” helps with selecting the correct layer for import.
6. Purging the drawing prior to saving can be beneficial by helping to avoid importing unwanted features that may not be viewable.

Importing a Part from a DXF File

Select the  icon from the tool path to import a DXF file. Choose the file you want to import from the dialog box.

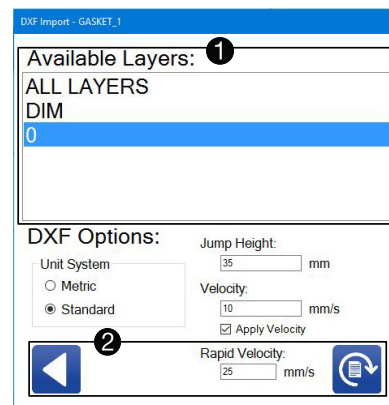

A list of the layers in the DXF file is located at the top of the import DXF window **1**. You can select one of the layers of the DXF to import at a time or you can select All Layers to import all of the layers in the DXF file.

NOTE: You cannot select multiple layers other than using the All Layers option. If you want to select another layer in the DXF file, you need to import the file again and choose the new layer. However, it will replace the current file, not append it.

At the bottom of the window, you can select to either return to the main programming screen without loading the file or to convert the selected layer of the file into program commands ②.



Back: Return to the main programming screen without importing the file.



Convert: Convert the selected layer of the DXF file into program commands. The selected options are used during this conversion.

Converting the Selected Layer(s)

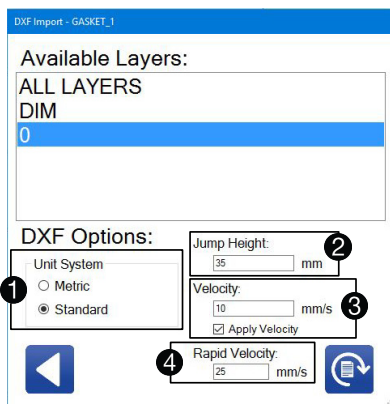

Unit System ① refers to the metric or standard units in which the DXF file was created. The units in the program created from importing the DXF must match the Unit System defined in the parameters. See **System Parameter Descriptions** on page 23.

For example, a DXF that is one inch square in inch units must be imported by selecting the standard unit system. If the unit system is set to inches in the parameters, the imported program is 1 in. x 1 in. square.

If the Unit System is set to metric in the parameters, the imported program is 25.4 mm x 25.4 mm square.

Selecting the wrong unit system results in the scale of the geometry being increased by a factor of 25.4 or reduced by a factor of 1/25.4.

If the imported pattern has multiple dispense segments separated by spaces, a jump command is inserted to transition between each segment ②. The Jump Height you enter is used for all jump commands in the imported program.

By default, no imported command has an associated velocity. Each command can be assigned the velocity you enter in the Velocity parameter ③.

If you check the Apply Velocity box, the velocity is assigned to each command in the imported program. If it is not checked, no program is assigned a velocity.

As set in the parameters, the Rapid Velocity is the maximum speed at which the system can move during rapid movements, such as Jump to Position commands ④.

NOTE: Large files may require velocities to be assigned on some layers. On these layers, it is not possible to un-check the Apply Velocity box.

Creating a Functional Program for a DXF File

A command list for the pattern is generated when the DXF file is downloaded. Commands appearing in red italics require information to be entered before the table can run the program pattern. The following table shows the command parameters that must be entered to complete the commands. Also see **System Parameter Descriptions** on page 23.

Command Parameters	Details
<i>Jump to Position</i> Every command must be edited individually.	Enter the Rapid Speed and the ZUp Speed if it is different from the Rapid Speed. Adjust the Jump Height if necessary (35 mm is the default and may cause the Z axis to hit the +limit depending on the Z height of the nest). Enter the Zend value to apply the offset between the needle and the part. (This value will be applied to the rest of the program through inheritance. See Inherited Command Properties on page 48.)

Command Parameter	Details
<p>Line, Arc, 3pt Arc, Spline - Once a value for each of these command parameters is entered, it is inherited each place the parameter is used in following commands.</p>	<p>Enter the Zend value to apply the offset between the needle and the part.</p> <p>Enter the Velocity value.</p>
<p>Circle - Every command must be edited individually.</p>	<p>Enter the Rapid Speed.</p> <p>Adjust the Jump Height if necessary. (35 mm is the default and may cause the Z axis to hit the +limit depending on fixturing.)</p> <p>Enter the Zstart value to apply an offset between the needle and the part.</p> <p>Enter a Rate if dispensing. If the rate is greater than zero, an End Dispense command needs to follow the circle.</p> <p>Enter parameters for lead in and lead out segments if necessary.</p>
<p>After the commands generated by the DXF file are completed, Dispense Commands can be added.</p>	<p>Place a Start Dispense command (enter Rate) at the beginning of each continuous segment to be dispensed and a Stop Dispense at the end of each segment. An optional Z Fast command can be placed at the end of a dispensed segment to quickly lift the dispense tip from the part and break any strings. (Using this command allows a different speed to be used than the Jump to Position.)</p>

Teaching Points

Commands that have the XEnd, YEnd, or ZEnd properties can have properties taught using the teach function. You can move the machine to a specified point and then set that point to be the endpoint for a selected command. You can also select to use only one or two of the X, Y, and Z coordinates when teaching points this way.

NOTE: Points cannot be taught unless the coordinate system matches a nest that is currently locked into place. The system checks the nest present sensor. If only one nest is in place, you cannot switch out of that coordinate system. If no nests are in place, you receive a message that you are unable to save any points.

Teach Controls

Select the  icon to open the Teach window for the currently selected command. Use the Teach window to lock in the slide, move the machine axes, jump to a specific position, and teach points. See **System Jogging** on page 20 for information about the jog controls.

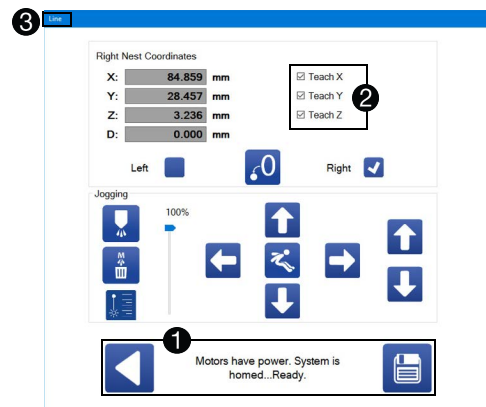

At the bottom of the Teach window are the controls to return to the programming screen ❶. Also, the machine state is displayed to aid in troubleshooting.



Back: Close the Teach window and return to the Programming screen. The endpoint for the currently selected command is not changed.



Save Position: Save the selected position as the endpoint for the currently selected command. If none of the teach options are checked, the endpoint is not changed. This button closes the Teach window. This does not save the current part.

In the upper-right corner of the Teach window, you can select which properties to teach with the current position ❷. Any of the X, Y, and Z settings that are checked are set. Additionally, if the current command is a three-point arc, you are given an option to teach the arc point, rather than the end point.

The Teach window title shows the name of the current command to make it clear which one is being edited ❸.

See **Teaching with Vision Enabled** on page 57 for a description of the Teach window when an optional camera is installed and enabled.

Position Display

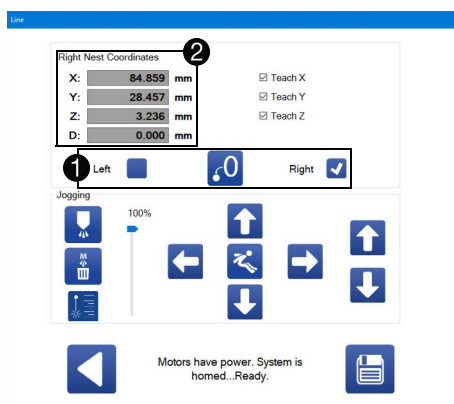

The options to change the coordinate system are displayed above the jogging control ❶. You can select the left nest or right nest coordinate system. The offset and skew for each coordinate system can be set in the parameters.

The Teach window displays one set of positions that are referenced when teaching the endpoint of a part. As such, the left and right nest coordinate system should generally be used. When creating a part for the Palletize command, you can also zero the system based on the desired zero location for the part.

NOTE: If a nest is not in place (as determined by the nest present sensor), you are not provided with the option to switch to that coordinate system. If only one nest is in place, the coordinate system is automatically set when the Teach window is opened.



Zero Here: Sets the current X, Y, and Z location to zero. This is intended for situations where the teach location needs to be offset from the final location, such as parts referenced by the Palletize command. This icon becomes the Clear Zero icon when selected.



Clear Zero: This icon clears a zero location set by the Zero Here icon and causes the display to resume showing either left or right nest coordinates. This icon becomes the Zero Here icon when selected.

The coordinate display in the upper-left corner of the Teach window shows the current coordinate system or the current offset from a selected zero point ❷. The taught position references these values. Changing the coordinate system after teaching these values does not change the saved endpoint values.

Position Display for Multiple Points

If a command has more than one point associated with it, such as a spline or three point arc, the Teach window adds a section that allows you to “commit” (select), multiple points prior to saving them.

On the left side of the Teach window is a list of the points that are associated with the current command ❶. The currently selected point is highlighted. You can select points independently; not all points need to be taught at the same time.

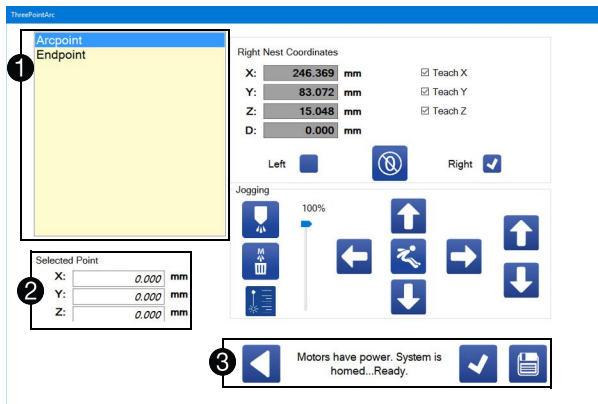

Below the point list is the committed value for the current point ②. Any value that is not committed is in *italics* and set to 0.000.

At the bottom of the Teach window are the back, commit, and save icons ③.



Back: Close the Teach window and return to the Programming screen. The values of all committed points are discarded.



Commit Point: Commit the values of the current point. If the current point is not the last point on the list, it automatically advances to the next point. The committed values of points can be viewed under the list of points.



Save Points: All currently committed points are saved and the Teach window is closed.

Selecting the Commit Point icon allows you to select multiple points that can be edited or deleted prior to saving them. Selecting the Save Points icon finalizes the point selection and closes the window.

You can still use the Teach X, Teach Y, and Teach Z check boxes while committing a point if you want to set only some of the coordinates.

NOTE: The current location is committed to the currently selected point in the same manner that the Save icon operates on the single-point jog screen.

Spline Functions

The Teach window has some additional functionalities with splines because the number of points that define a spline can vary.

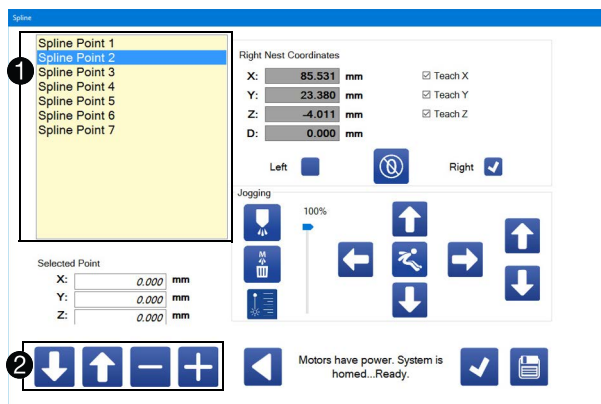

The list of points indicate enumerated spline points ❶. If you reorder the points in the list, the points are not renumbered on the display while you are reordering them. You must exit the Teach window and then reopen it to view all the points renumbered in order.

The controls for modifying the list of spline points are located at the bottom of the Teach window ❷.



Move Point Up: Swap the current point with the point above it. Points are not renumbered immediately when reordered. This icon is disabled if there is no point above the current point.



Move Point Down: Swap the current point with the point below it. Points are not renumbered immediately when reordered. This icon is disabled if there is no point below the current point.



Add Point: Add a spline point. The new point is added after the currently selected point. When created, the new point is automatically selected. All new points default to coordinates of 0,0,0.



Remove Point: Remove the currently selected point from the spline. The point that was after the one that was just removed is then automatically selected.

Using a Teach Pendant

In addition to the jogging controls on the Teach window, you can connect a game controller to the USB port of the development application computer to be used as a teach pendant. See **Component Identification** on page 8 for the location of the USB port.

Using a teach pendant allows you to jog more than one axis at a time. Commands can be appended to the end of the current program with the push of a button on the controller. If a command is added that has associated points, the Teach window opens automatically, allowing you to move to that position.

NOTE: Commands can still be added and inserted normally (not using the controller) in pendant mode.

The two models of game controllers that can be used are a Logitech® brand F310 Gamepad and a Microsoft brand Xbox One® Controller, Model 1537.

The input switch on the F310 Gamepad must be placed in the X position for it to operate

The Xbox controller also can be used with a Chatpad keyboard accessory for enhanced programming capability.

NOTICE

The Xbox controller can be operated as a wired or wireless device, but it is strongly advised not to use the wireless function with UniXact systems.

The UniXact systems have been designed and tested to work with tethered/wired teach pendants only. Use of the wireless function has not been evaluated for possible interference between the controller and other devices in an industrial environment, including UniXact machines. Unintended interference may cause equipment malfunction of the UniXact or other exposed industrial equipment.

NOTE: The teach pendant must be plugged into the computer when the UniXact software is started for the pendant to be functional.

Select the check box in the lower-right corner of the Programming screen to enable the teach pendant ①.

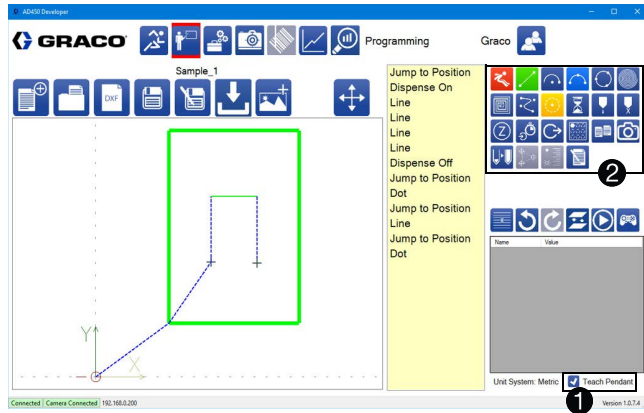

In pendant mode, four of the commands change color to match the A, B, X, and Y buttons on the game controller ②. The command mapped to each button can be set in the parameters. The command mapped to the A button changes to green, the B button to red, the X button to a brighter blue, and the Y button to yellow.

Teach Pendant Controls

Left Joystick: The left joystick (LJ) allows the system to move in X and Y directions. Tilting the joystick further causes the system to move faster, up to the jog rate specified in the parameters. The left and right triggers affect this speed. See **Jogging** parameters on page 25.

Right Joystick: Moving the right joystick (RJ) up or down allows the system to move in Z directions. Tilting the joystick further causes the system to move faster, up to the jog rate specified in the parameters. The left and right triggers affect this speed.

Left Trigger: Holding the left trigger (LT) button causes the system to move at a reduced speed while jogging to allow for precision control.

Right Trigger: Holding the right trigger (RT) button causes the system to move at an increased speed while jogging to allow for rapid motions. Holding the RT trigger button allows the system to move faster than the jog rate specified in the parameters.

A, B, X, and Y buttons on the controller are selectable. See **System Parameter Descriptions** on page 23.

NOTE: The Logitech F310 Gamepad is shown below.



The A button on the game controller confirms the current point. If the selected point is the last (or only) point associated with the current command, the jog screen automatically saves all confirmed points and closes to rapidly add and teach commands.



The B button on the game controller closes the jog screen without confirming or saving the current point.

Teaching with Vision Enabled

When an optional camera is installed and is enabled in the Vision parameters, additional features are added to the Teach window. See **Vision** parameters on page 31 and **Teaching Points** on page 52.

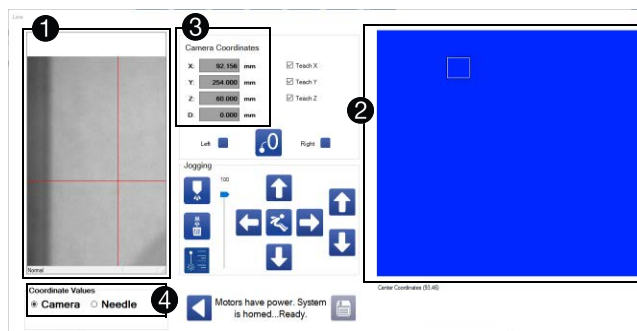

The camera view is on the left side of the screen ①. The cross hairs in the camera view window do not show the current needle position. The camera mounting location is offset from the true needle position. The software applies offsets to display the axes coordinates as if the needle were actually in the cross hairs.

It is extremely important that camera calibration is verified prior to using the camera. See **Calibrate the Vision Option** on page 74.

The work area view is on the right side of the screen ②. This represents the full viewing area of the camera. The small box within the work area view is the location of the current camera view. Dragging the box to another point in the work area moves the camera to that point.

The coordinate display defaults to the system coordinates if no nest is selected and locked in when the jog window is activated ③. Once a nest is selected and locked in using the left or right check box, the coordinate display changes to reflect that selection. See **Teaching Points** on page 52.

The displayed coordinates may be for the camera or needle position depending on which one you select ④.

NOTE: When programming, it is important to pay attention to which coordinate system is displayed to ensure the correct coordinates are taught.

Teaching by Sight

If you are teaching points by visually locating the needle over the part, select the appropriate nest, and then select Needle.

Teaching by Camera View

If you are teaching points by using cross hairs in the camera view, select the appropriate nest, and then select Camera.

NOTE: Teaching points by mixing the camera and needle options is not recommended. This can result in teaching wrong points if you do not remember to change the Camera/Needle selection box to match the teach method before saving the data. However, using mixed methods is sometimes necessary since the camera cannot view the entire work area due to physical constraints.

There are 6 possible coordinate systems that can be displayed:

- System Coordinates of Camera view
- System Coordinates of Needle tip
- Left Nest Coordinates of Camera view
- Left Nest Coordinates of Needle Tip
- Right Nest Coordinates of Camera view
- Right Nest Coordinates of Needle Tip

System coordinates are only used for teaching system parameters, and should never be used for programming. The Save icon is disabled when system coordinates are displayed. However, you still need to be aware of the current coordinate system displayed if you are using it as a reference for manually editing coordinates.

Barcode Reader

The Barcode option must be enabled on the Parameters screen for this function to be available.

Select the Barcode Reader icon  from the system functions at the top of the screen to open the Barcode screen. This screen allows specific barcode reading features to be associated with a program.

NOTE: The location of the barcode scanner and the barcode requirements may vary by application and are subject to change based on each application's unique requirements.

When the barcode input device is activated, the machine indexes to the barcode position. The scanner is then triggered to read the barcode and translate it to a text string. The system compares the text string from the barcode to the barcode text values that had been previously entered into the table on the screen.

Only programs that have been downloaded to the controller will appear in the Program pull-down menu.

The barcode scanner has a scan area of approximately:

- 24 x 20 mm at a distance of 110 cm
- 250 x 312 mm at a distance of 1000 cm.

NOTES:

- The barcode scanner will only function if the Part in Fixture parameter is enabled.
- Y-slides must be used for the standard barcode scan function to work.
- The barcode scan occurs before the part program is initiated.
- The barcode scan will not work within a sub-routine or within the Palletize command.

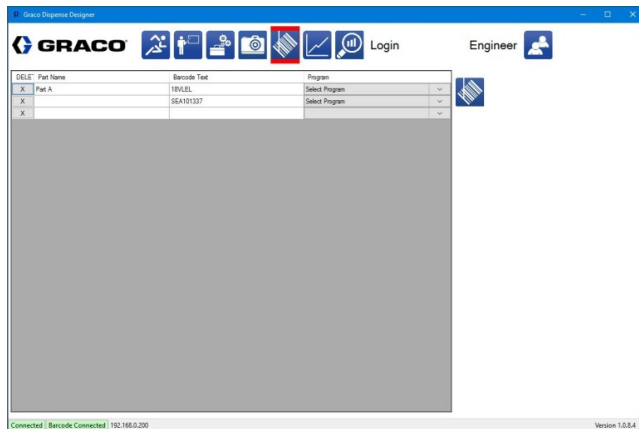

If the text string from the scanned barcode contains the barcode text on the Barcode screen, the selected program will run.

DELE	Part Name	Barcode Text	Program
X	Part A	1BVLEL	Select Program
X		SEA101337	Select Program
X			

If there is no matching barcode text or no barcode is found, a pop-up message is generated that states the barcode was not found. The machine exits Run mode and no part is run.

If no barcode text has been entered, the Program pull-down menu will be blank. The barcode text field must have a value to be associated with a program.

Operation

Select the  icon from the top of the screen to access the Operation function. The dispenser software must be connected to the machine’s controller to use the functions available on this screen.

The Run Screen

The Run (Operation) screen is used to run selected programs from the dispenser software. Also, you can perform basic tasks, such as homing the system, viewing and clearing alarms, initiating a manual purge, performing a dry run, moving to the maintenance position, and dispensing a test shot.

Programs can be tested with various Z offsets and at various speeds. The current and historical analog input values are displayed in the center of the screen.

NOTE: You cannot switch out of the Operation screen while the system is actively running.

Select Part Programs

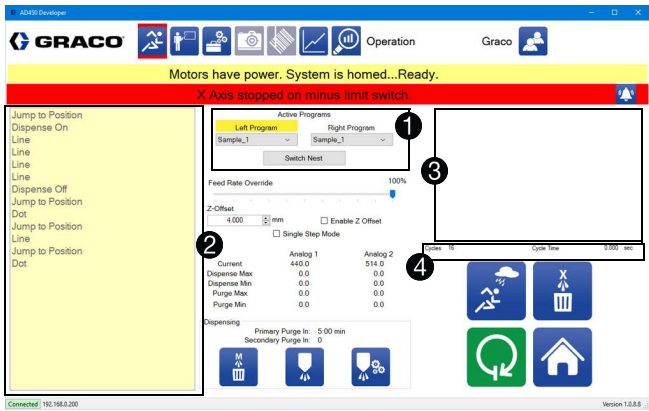

Select the programs to run from the Active Programs function located in the top-middle of the Run screen, just below the Alarm and Status bars ①. You can select the programs for the left and right nest independently using the drop-down list for each. The list includes all programs that have been downloaded to the machine’s controller. The selected programs can be the same or different.

Once you have selected a left and right program, use the Switch Nest button to toggle which program is displayed in the command list and image areas on the screen. Either the Left Program or Right Program heading is highlighted when that program is being displayed.

On the left side of the screen is the list of commands for the currently active program ②. As the system runs, the command being performed is highlighted on this list.

When a program is selected, the image of the part corresponding to that program is displayed in the upper-right side of the screen ③.

Cycle information is shown below the image of the part ④. Cycles displays the number of total cycles accumulated in the resettable cycle counter described in **SPC Data Screen** on page 64.

Cycle Time displays the elapsed time between the start event and completion of the part program. The start event is whatever causes the part program to begin. It could be a start button, a slide being locked in, or some other user-generated start input.

Run Controls

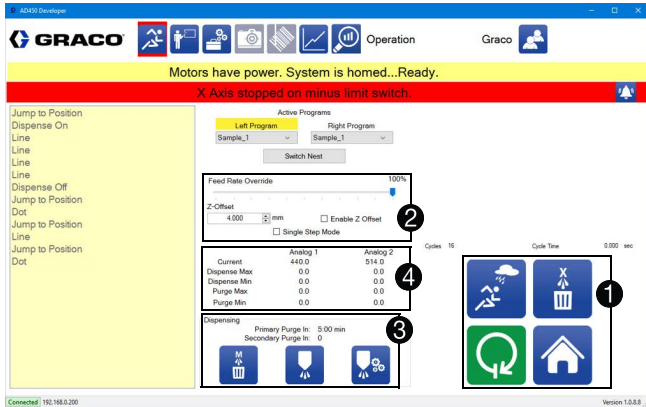

In the lower-right corner of the Run screen are the main controls for running the system. These icons are contextual based on the state of the system ①.



Wet Run/Dry Run: Toggles whether or not the dispenser is active during running. The icon that is showing indicates the current state of the system.



Autopurge On/Off: Toggles whether or not the system automatically purges. The purge timer still counts down regardless of the state. Manual purges can be toggled regardless of the state. The icon that is showing indicates the current state of the system.



Start/Stop: Allows you to start or stop the system. The system does not stop until it has completed any part it is currently running. This icon is disabled if the system is not in a suitable state to run.



Home: Causes the system to perform a homing routine. Homing is required after any loss of motion power. This icon is disabled if the system is e-stopped. During running, the Home icon becomes the Abort icon.



Abort: Causes the system to stop, even in the middle of running a part. There is no way to resume a program after an abort. While not running, the Abort button becomes the Home button.

In the center of the screen are global controls ②. The Feed Rate Override allows you to slow down the system to a percentage of the default values. The Z-Offset allows you to adjust the height of the current part in Z. The Single Step Mode allows you to switch the system to single-step mode.

NOTE: The Feed Rate Override does not affect the rate of dispense. Decreased feed rates may cause the valve to bottom out and fault the system.

NOTICE

Machine Offset parameters are not part of a program. Make sure you are running programs that were created using the currently set Machine Offset parameters or change the parameters to match the program. Failure to match the Machine Offset parameters to the program could result in damage to equipment. See **Machine Offsets** parameters on page 25 and **Calibrate the Machine** on page 66.

In the lower middle part of the screen is the purge information ③. The primary purge timer is reset by any dispense or purge, while the secondary purge time is reset only by a purge. If the system is in Autopurge mode and the time goes to zero, the system initiates a purge.



Manual Purge: Initiates a purge. This functions regardless of whether or not the system is in Autopurge mode. Manual purges also reset both purge timers.



Dispense Test Shot: Dispenses a test shot. The rate and amount of the test shot can be set in the parameters. The test shot can be dispensed while the system is in any position.



Go to Maintenance Position: Moves the dispenser to the maintenance position. The X, Y, and Z coordinates for the maintenance position can be set in the parameters. In the correct maintenance position, the door to the system can be opened without the system faulting.

Analog input information is displayed in the center of the screen ④. The labels for the analog inputs are the same as those in the parameters. The current value for each input is displayed, as are the minimum and maximum values for the last purge and the last dispense. If the system has been reset since the last purge or dispense, both the minimum and maximum values are zero.

Single Step Mode

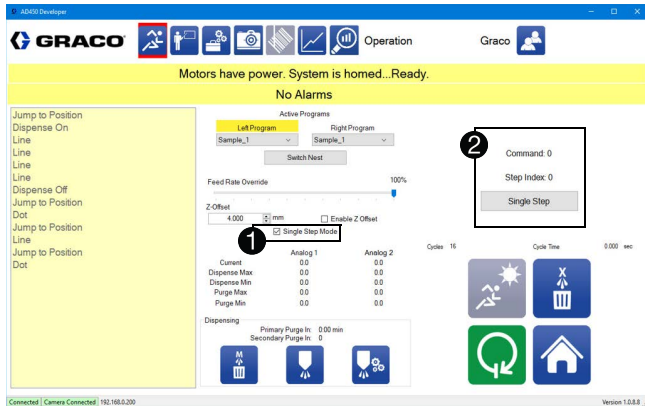

When Single Step Mode is selected in the global controls ❶, the part image is replaced by text indicating the current command, the index within the current command, and a button to increment to the next step ❷. All motion commands constitute a single step.

Each command may contain multiple individual steps, which can be tracked using the step index value. In Single Step Mode, the next still latches automatically, but the first move of the program is not made until the Single Step button is pressed.

Putting the system in Single Step Mode automatically switches the system to Dry Run mode.

System and Alarm Status

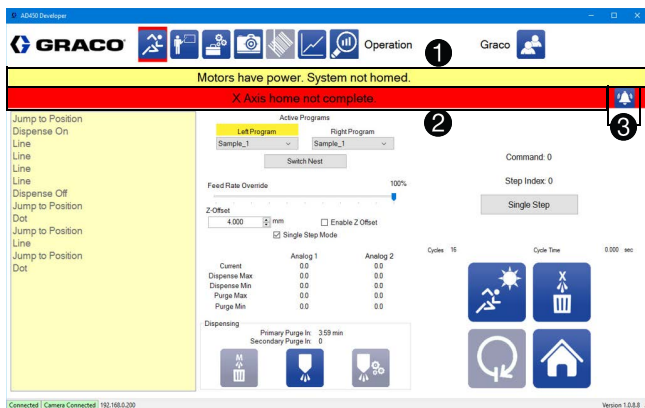

At the top of Run screen, there is a bar displaying the current status of the system ❶.

If any alarms are active, the bar below the status bar displays the first alarm and has a red background ❷. If there are no alarms, the bar is yellow and displays No Alarms.

The Alarm button is located to the far right of the alarm bar ❸. The alarm button is not visible if there is no alarm.



Alarm: Selecting the Alarm button opens the Alarm window so you can clear the alarms.

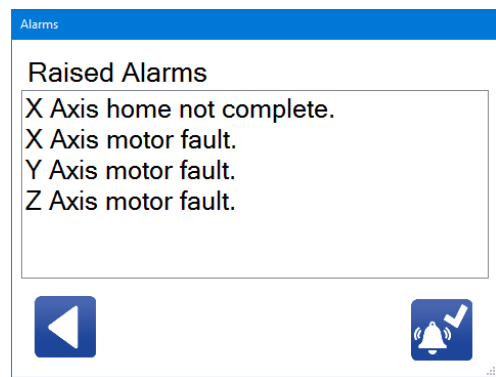

In the lower-right corner of the Alarm window is an icon to clear all alarms. Selecting this icon clears any alarms that are not currently active.



Back: Close the Alarm window and return to the run screen.



Clear Alarms: Clear all alarms that are not currently active.





NOTE: Alarms that are still occurring cannot be cleared. Some alarms require additional actions, such as homing, to clear them. To home the system, return to the

Run screen using the  icon and select the  icon.

Some alarms prevent the system from running. If the system cannot run, the Start/Stop icon is gray, indicating that it is not enabled. If the system is in a state where it can run, the Start/Stop icon is green .

For a listing of possible alarms, see **Error/Event Alarms** on page 90.

Prepare to Run a Program



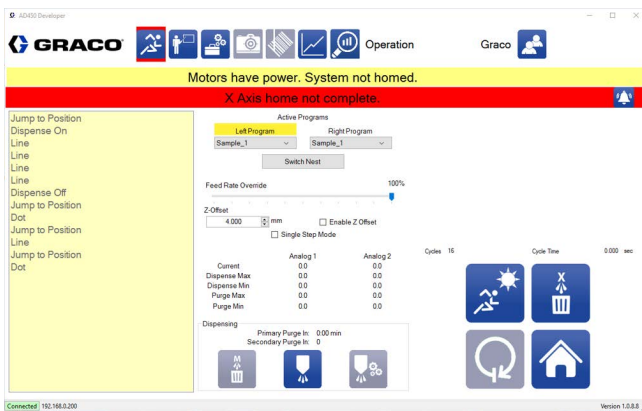



1. Log in to the dispenser software and select the  icon to open the Maintenance screen.
2. At the Maintenance screen, select the  icon in the lower right corner of the screen to go to the parameters list. Scroll to the Needle Find parameter and select it to Enable it.
3. Select  to save your changes.
4. Select the  icon to go to the Run screen.





5. Select the  icon to go to the maintenance position.
6. If you are using a C-300 with an access door, open the door.
7. Prepare the dispense valve nozzle for production. Refer to the manual for the dispenser you are using for information about preparing the valve. See **Related Manuals** on page 3.
8. Install a new mixer, shut off valve, and needle as applicable.

NOTE: If your process requires an extra level of validation, ratio validation should be done prior to installing the new mixer hardware. Refer to the manual for the dispenser you are using for specific information about this. See **Related Manuals** on page 3.

9. Verify that the material feed system is set up to run. See the manual for the feed system you are using.

10. Close the door if you are using a C-300 with the access door.
11. Press the green control power button on the front of the machine to activate the axes.
12. Select the  icon at the Run screen to teach the needle position.
13. Select which program should run in the left and right nest using the Active Programs section on the Run screen.
14. Select Dry Run, , at the Wet Run/Dry Run icon.
15. Select  to enter run mode.
16. Push in each slide to verify the pattern. Motion should begin when the slide is pushed in.
17. Select  to exit run mode.
18. Return to the maintenance position by selecting the  icon again.
19. If you are using a C-300 with an access door, open the door.
20. Place a container under the dispenser outlet.
21. Prior to dispensing, select the  icon and advance to the parameters list. Adjust the shot size or number of shots to dispense approximately two times the volume of the mixer.
22. Return to the Run screen and use the dispense test shot  icon to prime the mixer.
 - a. Dispense a shot.
 - b. Examine the material to visually verify the mix.
 - c. Continue to dispense shots until the material is of uniform consistency.
23. Close the door if you are using a C-300 with the access door.
24. Press the green control power button on the front of the machine to activate the axes.

25. At the Run screen, select Autopurge On, .
26. Select Wet rRun, , at the Wet Run/Dry Run icon.
27. Select  to start production.
28. If the machine is equipped with a light curtain instead of an access door, wait for the machine to index to the load position. See **Safety Circuit Design** on page 89 for more information about the load position.
29. Load parts to dispense.

Ready to Run

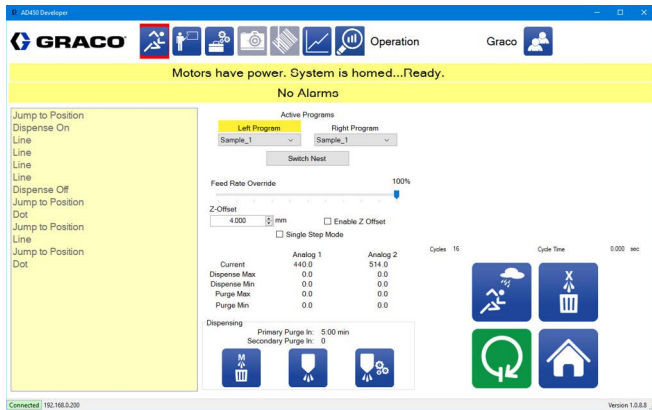

Shown is an example of a screen with the system ready to run. Both nests are setup to run Sample_1. The Start icon is enabled, and the system state indicates that the system is ready.

Press the  icon to run the selected parts.

SPC Data Screen

The SPC data screen provides statistics about the current system. Values from the analog inputs are recorded for the last run and the last purge. Also, cycle counts and amount dispensed are displayed.

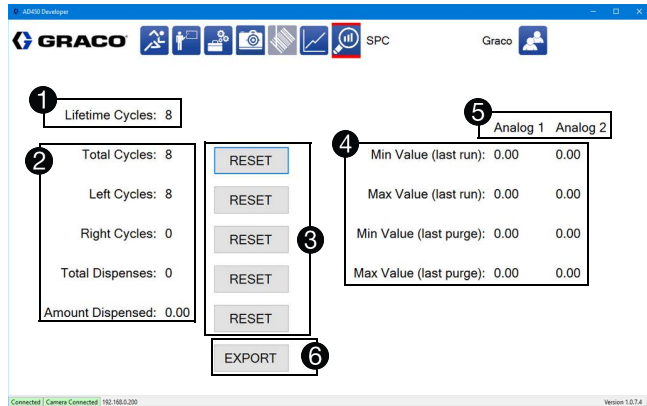

The lifetime cycle count for the current system is displayed in the upper-left of the SPC screen ①. This value cannot be reset. Each part run on each nest counts for one cycle.

Located under the lifetime cycle count is more general cycle information ②. The total number of cycles as well as the number of cycles on each of the left and right nests are included. The total number of dispenses and the total amount dispensed are listed at the bottom.

The general cycle information can be reset, as can the total number of dispenses and the amount dispensed. A reset button is located to the immediate right of each value ③. When Total Cycles is reset, the cycle information on the Run screen is reset. See **Select Part Programs** on page 59.

The minimum and maximum value for each of the two analog inputs are listed from the last purge and from the last dispense ④. On a reset, these values are zero. The values listed are scaled based on the information in the parameters.

The two analog inputs are displayed using the names given on the maintenance screen ⑤.

Selecting the Export button opens a window to download recorded analog data for a specified data range to a specified location and file name ⑥. The data is exported in .csv format.

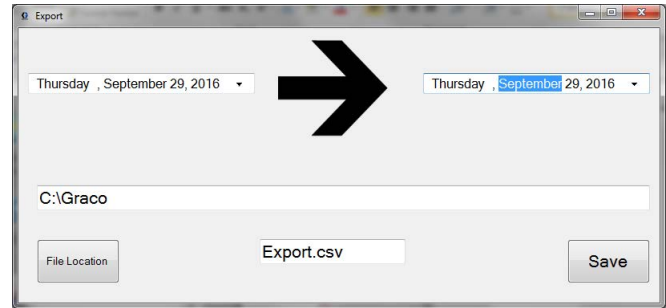

NOTE: Data is only recorded to the database when the machine is in Run mode. Taking the machine in and out of Run mode causes gaps in the time line where there is no data.

Charting the Data in Microsoft Excel

Use of a scatter chart in Excel shows a true time line and fills in gaps on the time axis where there is no data.

A normal line graph shows only the tabled data. Gaps in the time line are not readily evident.

The sample rate is 4 per second. Best practice would be to graph only continuous blocks of data.

Graphing Data

The Graph feature allows you to dynamically display pressure data for Analog 1 and/or Analog 2 channels.

NOTE: Analog channels must be enabled in the parameters. See **Analog Inputs** parameters on page 30.

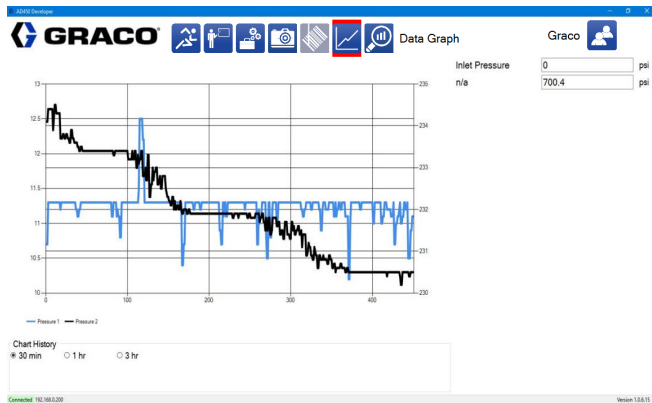

High and Low warnings and alarm setpoints (defined in the parameters under Analog Inputs) are displayed on the graph. A chart history of 30 minutes, 1 hour, or 3 hours can be shown.

Pressure data is condensed to display and record only while the machine is in Run mode. The chart display does not reflect real time data unless the machine was in Run mode for the entire chart duration.

Displayed data is written to a database and can be exported to a .csv file by using the export button on the SPC screen. See **SPC Data Screen** on page 64. The data is time stamped with the date and time and is collected at a rate of 4 hz.

The labels for Analog 1 and Analog 2 can be edited to be more application-specific at the Maintenance screen. See **Manage Inputs and Outputs** on page 18.



NOTE: This feature requires the optional pressure transducers.

Advanced Calibration Features

Calibrate the Machine

The UniXact machine calibration process should be performed when first connecting to the system and when switching to a new program with a different part pattern. You should have a thorough understanding of the UniXact system and software before beginning this process.

Prior to performing calibration, the dispenser needs to be moved to the Home position on the machine.

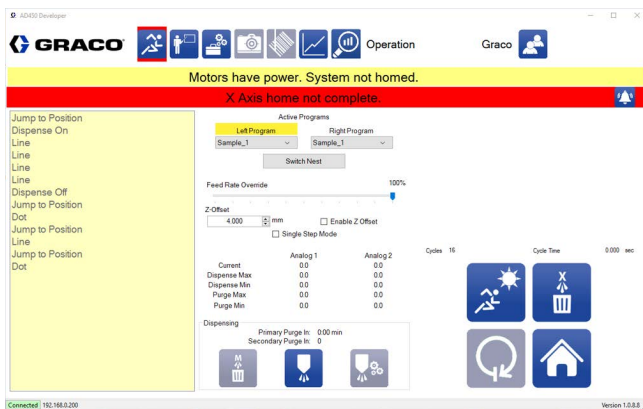

1. Select the  icon to go to the Run screen.
2. Select the  icon to home the dispenser.



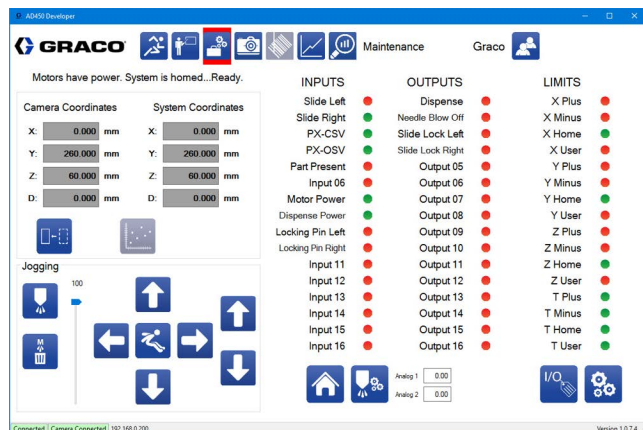

To access the machine calibration setup function:

1. Select the  icon to open the Maintenance screen.

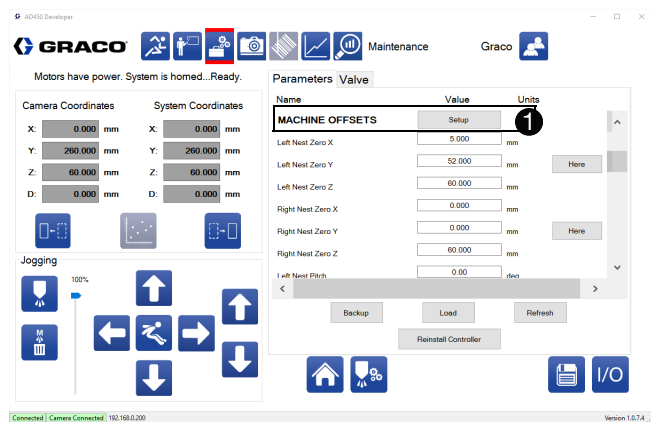

2. At the Maintenance screen, select the  icon in the lower right corner to switch to Parameters.
3. At the parameters list, use the scroll bar on the right side of the Parameters tab to scroll to the Machine Offset parameters.
4. Select the Setup button next to Machine Offsets .



This opens the Machine Setup window that allows you to set the flatness and skew of a part by finding points on the part and having the system automatically calculate the approximate angles. Also, you can set machine offset values and calibrate the dispenser valve .

NOTE: Each calibration stores and saves its values independently of the others. For example, saving the flatness values does not save the skew values.

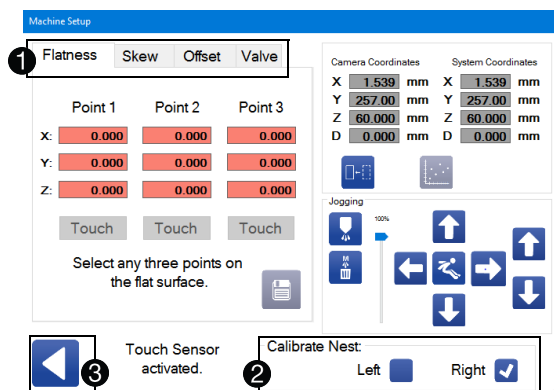

The nest must be selected and locked in by checking the appropriate Calibrate Nest box ②. The back icon closes the Machine Setup window ③. Any unsaved data is discarded. You are warned if there is unsaved data when you attempt to close the window.

Select a Nest

1. Place your part in one of the nests and push in the slide with the part until it stops. Hold it in place.

NOTE: Select a part that most accurately represents the normal dimensions of the part for your application.

2. Lock the slide into place by selecting the corresponding left or right check box located in the lower right corner of the window.

NOTE: If the nest selected is not in position, the check box turns red and the status text changes to “Nest not locked in.” When the nest is locked into place, the check box turns blue.

Calibrate Flatness

Flatness calibration enables the system to compensate for parts that are angled up or down on the Y axis (pitch) and/or left or right on the X axis (roll). This process aligns the actual X-Y dispense plane of the part with the X-Y motion of the table.

When flatness is calibrated, the software corrects the Z axis so the dispensing tip tracks parallel to the surface of the part, adjusting as if the part is perfectly flat in the nest. This minimizes the need to shim or adjust the part.

NOTE: Flatness calibration does not correct for parts that are cupped or twisted or have any raised areas. The part surface itself must be flat.

NOTE: The optional touch sensor available for the UniXact machines must be installed to calibrate flatness. See the installation procedure for installing the touch sensor in **Appendix D: Touch Sensor Installation** on page 98.

To calibrate flatness:

1. Select the Flatness tab.
2. Use the Machine Setup window’s jogging controls to move to approximately 5 mm above a point on the part. See **System Jogging** on page 20 for information about using jogging controls.

3. Select the Touch button ①. This causes the dispensing valve to move down until the sensor has recorded that it has reached the part surface. Upon completion, the dispenser moves back up to its start point and displays the recorded value. If the surface is not found, the dispenser does not move back up.

NOTE: The dispenser does not move more than 20 mm when seeking the part surface.

4. Repeat step 2 and 3 for the other two points.

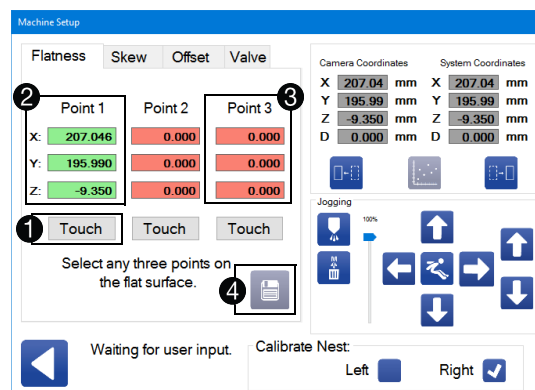

NOTE: Three distinct points must be taught for the system to compute the flatness. Distinct points where the sensor successfully recorded a value are shown in green ②. All three points must form a triangle in the X-Y plane to be valid. The three points cannot be in a straight line. Points that have not been recorded, points where the surface was not found, and points that are at an identical location to a previous point are displayed in red ③. These points must be selected (or re-selected) before flatness can be computed and saved.

5. When all three points have been successfully taught, the Save icon  is enabled ④. Select it to compute and save the corresponding flatness.

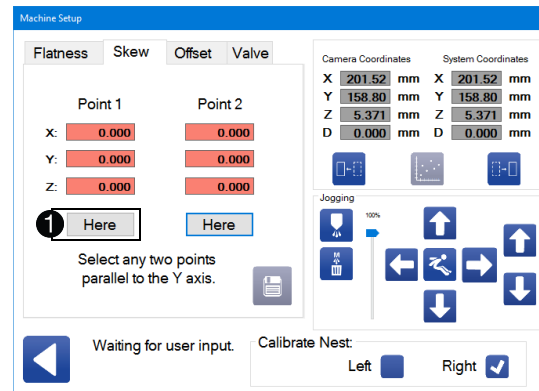
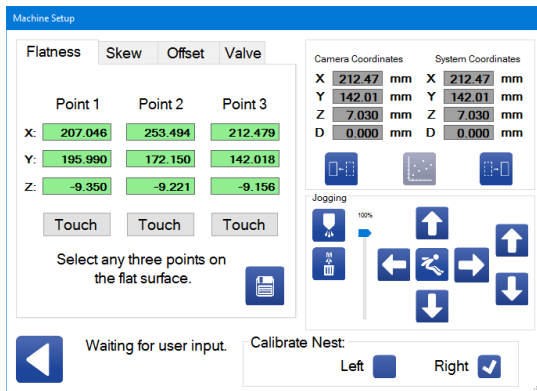

NOTE: The coordinates are shown as the distance of that point from the absolute (machine) coordinates.

The computed flatness can be seen and edited as Nest Pitch and Nest Roll (left and right) under the Machine Offset parameters. See **Machine Offsets** parameters on page 25.

Calibrate Skew

Calibrating the skew of a part compensates for parts that are turned (skewed) in a nest. The part might only be very slightly skewed as in the example below, but any variation from perfectly parallel with the sides of the nest affects the material dispensing if you do not properly calibrate the skew.

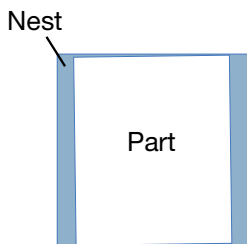

This feature minimizes the need to manually adjust the position of the part in the nest.

The screen for calibrating skew is similar to the screen for calibrating flatness, although only two points are needed. Those two points do not require the use of the touch sensor. The Z axis field will have a value, but that value is not required for calibrating skew.

NOTE: The two points must form a line parallel to the Y axis of the part for the skew to be correctly computed. When calibrated, the software translates both axes to maintain a path that is parallel to all four sides of the part.

To calibrate skew:

1. Select the Skew tab.
2. Use the Machine Setup window's jogging controls to move to the first point on the part.
3. Select the Here button ①.
4. Move to the second point on the part and press the Here button to confirm the current location for the second point.
5. After both points have been taught, select the  icon to save the skew values.

The nest skew values can then be viewed and edited under the Machine Offset parameters on the Parameters screen. See **Machine Offsets** parameters on page 25.

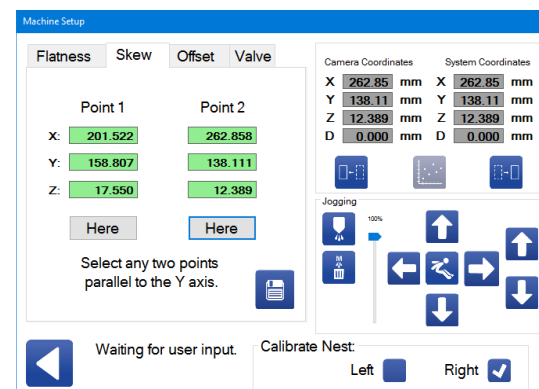

Set Machine Offsets

The machine offset tab allows you to set the machine offset values for the selected nest. These parameters can also be set in the parameters. The offset feature here is intended for use with a touch sensor to more accurately locate the Z coordinate. See the installation procedure for installing the touch sensor in **Appendix D: Touch Sensor Installation** on page 98.

The Here button next to the X, Y, and Z coordinates sets the origin coordinate as a value that is offset from the machine's absolute coordinate ❶.

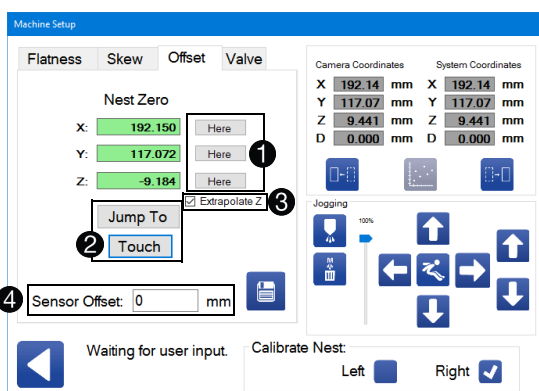

The Jump To button requires the touch sensor to be installed. It moves the sensor to allow you to jump to a specific point ❷. The Touch button causes the Z axis to lower until the touch sensor contacts the part surface. When contact is made, the Z coordinate of the part is recorded.

The Extrapolate Z check box works with the Touch button. When checked, the software calculates the Z coordinate at the part origin ❸. The calculation is based on the assumption that the part surface is flat. Flatness calibration must be performed before using the Extrapolate Z function or the calculated value will be wrong.

NOTE: The Extrapolate Z feature is useful if the actual zero point of the nest does not fall on the part. An example of this would be a rectangular or square part with rounded corners. The likely origin point would be at one of the corners where two of the edges would intersect if extended.



A Sensor Offset button is provided because there is a slight difference in distance between the point at which the touch sensor contacts the part and the point at which the sensor registers the contact ❹. The switch provided for this purpose is a precision micron displacement switch that has a zero offset. The sensor offset value (if applicable) is added to the Z value that is captured by the sensor before being recorded.

To set the machine offsets:

1. Select the left or right nest where you want to set the machine offsets.
2. Use the Machine Setup window's jogging controls to move to a point along the X axis of the part and then select the Here button.
3. If necessary, use the jogging tool to do the same for the Y axis.
4. If a touch sensor is installed, jog to approximately 5 mm above any point on the part, check the Extrapolate Z box, and select the Touch button. When contact is made, the Z coordinate is set to that location.

NOTE: For the most accurate results, pick a point on the part that is as close as possible to the origin.

5. Select the Here button to confirm the value.
6. Manually enter the Sensor Offset value. Refer to the instructions included with the touch sensor to determine what this value should be.
7. Select the  icon to save the values.
8. After the first nest has been set, repeat steps 1-7 for the other nest if needed.

NOTE: Accurately setting the Z coordinate of the nest can be difficult if the nest is at an angle. The flatness, Nest Zero X, and Nest Zero Y values must all be accurately recorded for the Extrapolate Z function to compute an accurate value.

Calibrate the Valve

The UniXact machines are equipped with a dispense axis motor that provides additional calibration functionality for the dispenser valve. The Valve tab at the Machine Setup window allows you to jog the dispense axis motor clockwise or counterclockwise, which controls down or up movement of the valve.

NOTE: The direction of rotation can have a different result depending on the type of dispenser being used. Some valves may not utilize over-travel switches to prevent excessive motion in one direction. Make sure you are familiar with the dispense valve you are using before performing this calibration.

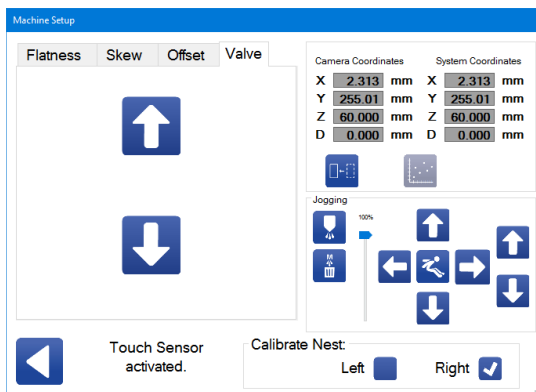

The two jogging controls on the Valve tab are located separately from the other jogging controls because they only control the dispense axis motor, not the dispense valve itself. They do not trigger any other outputs to shift spools or shut valves off and on.



Negative Dispense Jog: This causes the dispense axis motor to rotate counterclockwise (when looking at the end of the motor shaft).



Positive Dispense Jog: This causes the dispense axis motor to rotate clockwise (when looking at the end of the motor shaft). This results in material being dispensed.

NOTE: For the PD44, 1053, and 1093 dispense valves, counterclockwise rotation results in upward movement of the metering rod as part of the reload sequence. Clockwise rotation results in downward movement of the metering rod as part of the dispense sequence.

Exit the Machine Setup Window

Make sure all data is saved before exiting the Machine Setup window. If you try to leave, switch nests, or un-select a nest while there is unsaved data recorded, a message pops up asking you to confirm that you want to leave and lose the unsaved data.

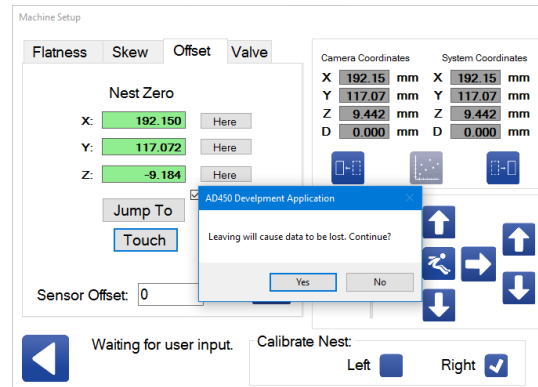

Calibrate the Part Present Sensor Option

The part present sensor is optional. If one is installed, you need to calibrate it prior to dispensing. The sensor is located on the dispenser and emits a red light onto the slide where the part is located.

NOTE: Make sure all parameters are saved before performing this calibration procedure.

1. Locate a part in the nest.
2. Push in the slide with the part. Hold the slide in place and then lock it by toggling the appropriate slide lock output on the Maintenance screen. See **Manage Inputs and Outputs** on page 18.
3. Using the controls on the Maintenance screen, jog the dispenser to position it so the part present sensor “sees” the part. The position selected should be close to the starting dispense point on the part to minimize cycle times. See **System Jogging** on page 20 for information about using jogging controls.

NOTE: The sensing range for the sensor is between 10 cm and 40 cm.

NOTE: When this feature is active, the machine automatically moves to this position to look for a part each time the slide is locked in (or the start device is activated).

4. Cycle power to the machine on and off to place the part present sensor into programming mode. Pressing the red control power off button on the front of the machine turns the machine off. Pressing the green power control button on the front of the control panel turns power back on.

NOTE: The red light flashes when the sensor is in programming mode. A solid red light means it is no longer programmable and the power needs to be cycled again.

5. Follow one of the sensor calibration routines. You can find the instructions for these routines by accessing the Graco Dispenser Documentation folder on the system computer’s desktop.

NOTE: The sensor can be set as either Light on or Dark On. Program it so the Light On option is active. Refer to the documentation included with the Baumer sensor (part present sensor) for information about this setting.

Calibrate the Pressure Sensor

This calibration process is for when you are using the PD44 dispense valve with the 1500 psi sensor (kit no. 245032). For more information about this valve, see **Appendix E: Dispenser Integration** on page 99.

UniXact machines with older versions of the controller interface board had a 0-10 v amplifier and used only one type of sensor. Machines built in 2016 or earlier with the 0-10 v amplifier are revisions A-D. The boards with revision E or greater use 0-5 v sensors and offer several sensor options. See the table in step 4.

To determine what version of board you have, refer to the part number 17F780- in the upper right corner of the circuit board as shown in **Figure 12**. The letter in the “-” position refers to the board’s revision.

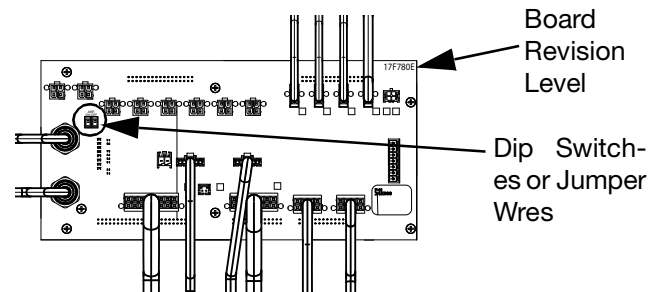

FIG. 12: Controller Interface Board

The controller interface board has either two ON/OFF dip switches or two jumpers that activate the 0-5 volt amplifier. These are located next to the input plugs for kit no. 245032. See **Figure 12**. The dip switches should be in the ON position and the jumpers should be horizontal when using this kit. The dip switches should be OFF and the jumpers vertical for non-amplified input.

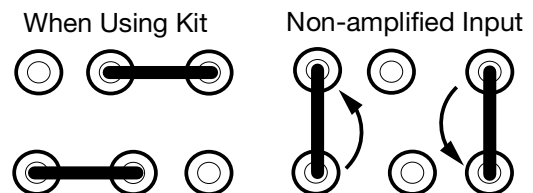

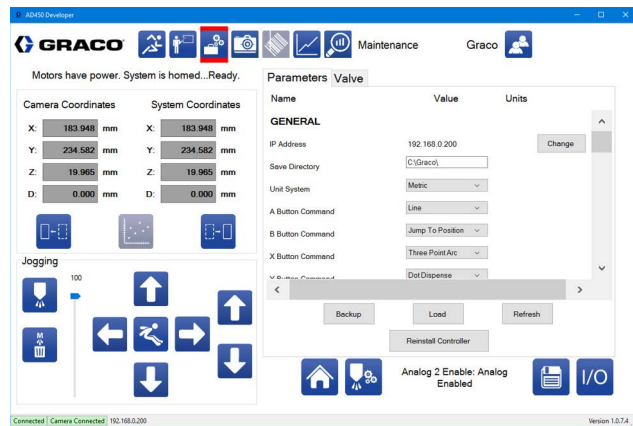



FIG. 13: Jumper Positions

1. Select the  icon at the top of the screen to open the Maintenance screen.
2. At the Maintenance screen, select the  icon to switch to Parameters.
3. At the Parameters list, scroll to the Analog Inputs.
4. Enter the appropriate analog value for the sensor you are using based on the voltage and board revision. Refer to the table below.

Analog Value at * Volts	
Revision	Sensor and Value to be Entered
A-D (0-10 v)	16P290 (0-2000 psi), use 2950
E or greater (0-5 v)	16P289 (0-500 psi), use 1453
	16P290 (0-2000 psi), use 5780
	16A093 (0-5000 psi), use 8452

5. Make sure the analog offset values are set to zero.



6. Loosen the nose assembly to ensure there is no trapped pressure between the pressure sensors and the ball checks.
7. Select the  icon to return to the Input/Output (I/O) screen.

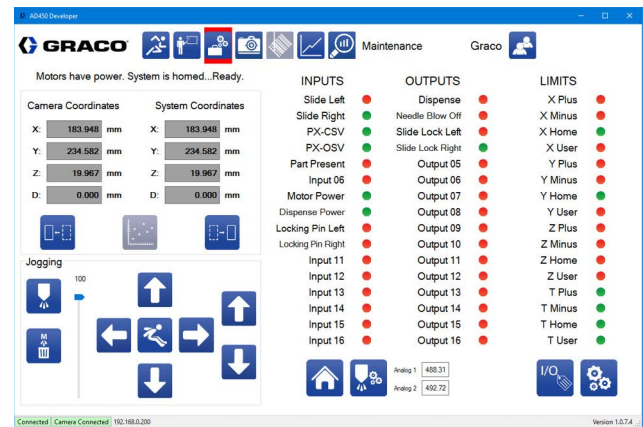

8. Read the pressure values for Analog 1 and Analog 2 that are displayed near the bottom of the screen. See **Manage Inputs and Outputs** on page 18.
9. Return to the Parameters list. At the Analog 1 Offset and Analog 2 Offset parameters, enter the displayed pressure values from the I/O screen as offsets.

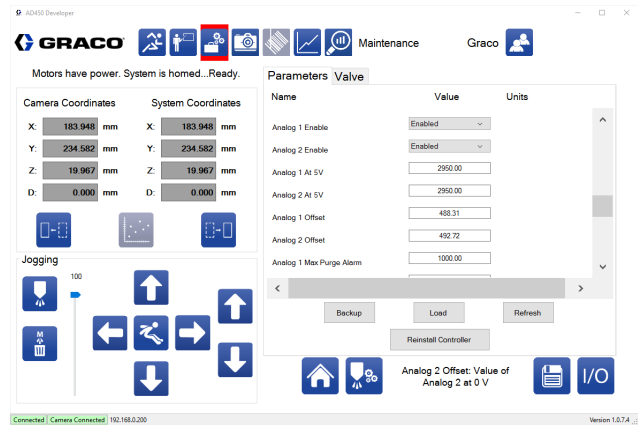

10. Return to the I/O screen. The analog outputs should show as zero +/-1.

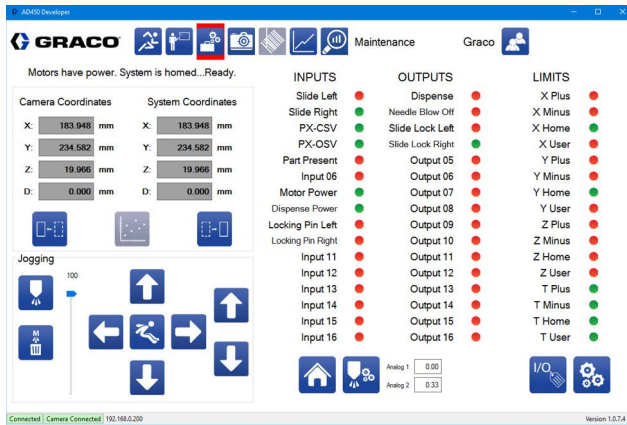





11. Tighten the nose assembly.

NOTE: Tightening the nose assembly may cause the pressure to change to a value greater than zero.

Calibrate the Vision Option

The optional camera allows for enhanced programming using the camera image. It can be used to fine-tune the location of the part pattern based on the actual position of the part. See **Using the Vision Command** on page 42. This calibration procedure is application-dependent.

If calibrating for the first time, read **Camera Setup Considerations** and **Focusing the Camera** in this section before performing the following calibration steps.

1. Select the  icon at the top of the screen to open the Maintenance screen.
2. At the Maintenance screen, select the  icon to go to the Parameters list.
3. Select Enabled for Needle Find and Disabled for Vision.
4. Select  to home the system.
5. Use the jogging controls to teach the Circle Calibration Needle Location X, Y, Z. This parameter is located in the Needle Find parameters.
6. Jog the needle so the tip is precisely in the center and touching the surface of the calibration dot. Select Here to teach.
7. Select Enabled in the Vision parameters to begin calibration.
8. Select the camera icon  from the systems functions menu at the top of the screen to open the live camera view window.
9. Jog the axes to position the camera cross hairs in the center of the calibration dot.
10. Focus the camera to show a crisp, well-defined image using the up and down arrows in the jogging controls. See **Focusing the Camera** in this section.
11. Make sure the focus and aperture lock screws are tightened. See **Figure 14** on page 75 for the location of these parts.
12. Select Here to save.
13. Wait until the Calibration Complete message appears. The live camera view should be highlighted as shown below.
14. Verify that the Vision parameters for Vision Calibration Location X, Y, and Z, Circle Camera X, and Y, and Pixel to MM Factor have been populated.
15. Close the live camera window.

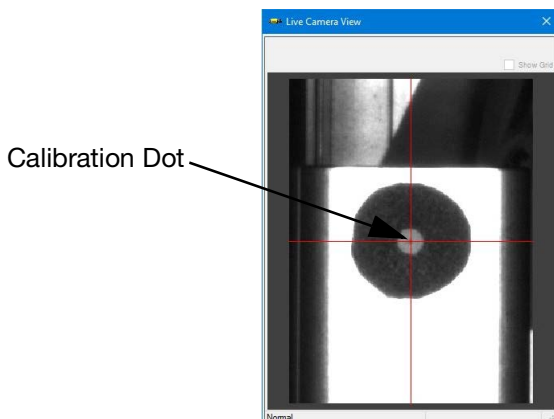
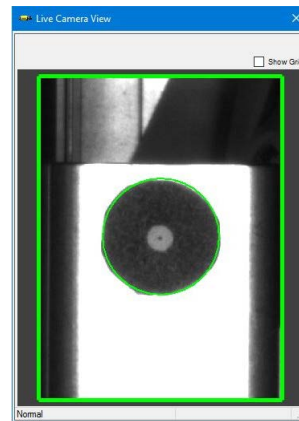

Camera Setup Considerations

It is important to read through the entire camera calibration process before attempting calibration. All factors must be considered to successfully calibrate for production.

These three conditions must be satisfied for both nests (if applicable).

1. The camera and part location must be selected so the axes can move the camera to each of the following locations and view the target without obstructions:
 - Calibration dot location
 - Dispense areas of the part if programming with the camera.
 - Fiducials used to orient the part if using the Vision command.
2. Fiducials must fit into the camera's field of view. The nominal field of view is 14 mm X by 19 mm Y at 25 cm focal distance.
3. The same nominal focal distance must be maintained during the Home routine and when the Vision command is executed. The focal distance is the distance between the camera lens and the target object.

Alternate placement of the following hardware may need to be considered:

- Part/fixture
- Calibration dot and/or needle find
- Dual Y slide
- Camera
- Z axis (reposition to increase max Z height)

The camera must be set up to establish image scaling as part of the Home routine. The focal distance used for the vision calibration location must be selected with consideration of the part in the nest. The same focal distance must be maintained between the following:

- The camera and the scaling target used for calibration location during the Home routine.
- The camera and the nest location used when the Vision command is executed.

NOTE: The numeric values for the Z component of the vision calibration location coordinate and the Z component of the nest location coordinate will be different. These two positions are located in different coordinate systems.

Focusing the Camera

The camera has a fixed focal length with a minimum focusing distance of 25 cm (9.8 in.) This means that the best image will be located a fixed distance from the camera lens, and the size of the image will change if the object is moved closer or farther way. The focal distance can be adjusted somewhat with the focus adjustment ring, but this is a one-time adjustment.

The position of the Z axis needs to be considered when focusing the camera lens. The camera needs to be positioned so that the same focal distance can be achieved at all locations of interest (calibration dot, fiducials, and dispense surfaces). There is height adjustment in the camera bracket to help meet these requirements.

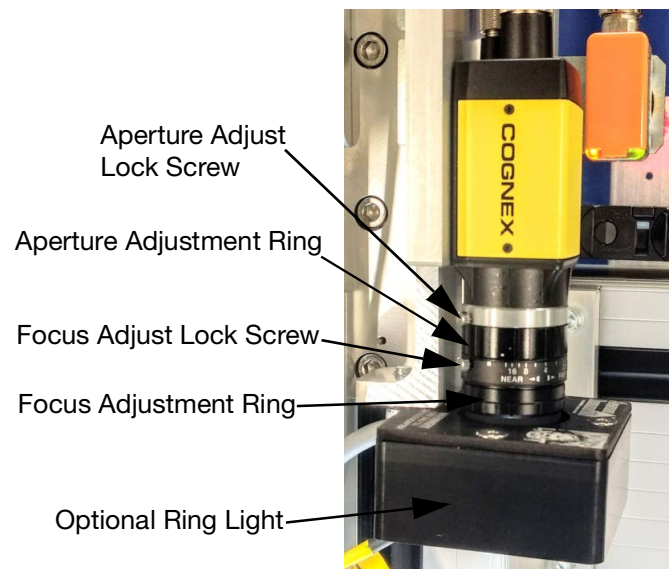

FIG. 14: Camera Parts

The aperture adjustment controls how much light exposure is allowed. This should be adjusted to allow the necessary degree of contrast and detail in the image. Too much light can wash out detail. This adjustment may be helpful to allow clear viewing of the desired feature, while minimizing surrounding or background details.

Aperture adjustment is most critical for finding fiducials. Adjust the aperture setting to maximize contrast between the fiducial and the surrounding area.

NOTE: Ideally, the area surrounding the fiducial should be somewhat washed out with light, leaving only the fiducial in view.

All camera commands in the part program as well as the camera calibration need to be updated (reprogrammed) when the positional relationship between the camera, the dispense needle, and the calibration dot is changed. The following actions change the positional relationship.

- Adjusting the focus with the camera lens.
- Adjusting the aperture with the camera lens.
- Changing the needle find position.
- Changing the position of the dispense tip (if it requires the needle find to be moved).
- Changing the calibration circle position.
- Repositioning or moving the camera.
- Repositioning a part fixture or placement of the part in the fixture.

Vision Camera Troubleshooting





To ensure that the camera functions properly:

- The camera must have a good Ethernet connection (port lights will blink).
- The IP address needs to be set on the parameters screen to 192 168 000 200.
- The camera trigger signal needs to be connected to the computer output 5 (connector P3B on the controller interface board). You will still see an image if this is not connected.
- The LED labeled “ENET” on the top of the camera should be flashing orange.
- The bottom left corner of the frame around the live camera view should have the word “Normal” displayed (not disconnected).

Calibrate the Laser Option



An optional laser feature is available for use with a UniXact system.

1. Select the  icon at the top of the screen to open the Maintenance screen.
2. At the Maintenance screen, select the  icon to go to the parameters list.
3. In the parameters, select Enabled for Needle Find and Disabled for Laser.
4. Select  to Home the system.
5. Scroll to the Laser parameters. See **Laser** parameters on page 31.
6. Select to enable the Laser .
7. Use the jogging controls to jog the axes so the laser dot is centered on the calibration circle located on the needle find assembly.

NOTE: Ideally, laser positions should be taught with the laser positioned at a sensing height close to the middle of its measuring range. A read out on the amplifier between +5 and -5 is close enough to the middle of the range. This will ensure variations in position do not cause measurements to fall outside the range of the sensor and trigger an error.

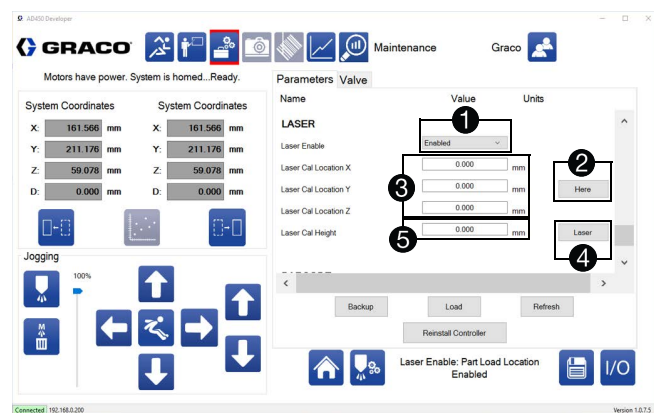

8. Press the Here button ② to teach the Calibration Locations for X, Y, and Z ③.
9. Press the Laser button ④ to read the height at the calibration location ⑤.
10. Home the system, and verify the laser dot appears in the calibration circle after the homing process is complete.

NOTE: The laser sensor requires a 30 minute warmup time after turning it on to stabilize the circuitry. The displayed measurement value may drift during this time.

All laser commands in the part program as well as the laser calibration need to be updated (reprogrammed) when the positional relationship between the laser, the dispense needle, and the calibration dot is changed. The following actions change the positional relationship.

- Changing the needle find position.
- Changing the calibration circle position.
- Repositioning the laser sensor.
- Repositioning a part fixture or placement of the part in the fixture.

Laser Sensor Troubleshooting

To ensure the laser sensor functions properly:

- The Laser Amplifier Setup routine must be completed. See **Laser Amplifier Setup** in this section.
- The USB cord from the laser must be connected to the motion controller board.
- The LED on the USB connector should flash a few times momentarily when it is first plugged into the motion control board.
- The USB connector should flash each time the Laser Shot button on the jog/teach window is selected.
- The green Power LED on the laser's RS-232 module should be illuminated.
- The green Laser LED on the laser amplifier should be illuminated.
- The digital display on the amplifier should have a readout value between approximately -30 and +25 when it is in range and a readout of - - - - when it is out of range.

Laser Amplifier Setup

Before calibration can be completed, the hardware must be set up to make the laser functional. The laser amplifier is connected to an RS-232 module and they are both located in the lower right corner of the electronics inside the access panel.

NOTE: This setup procedure will be performed in the factory prior to shipping if the laser option is factory installed.

The laser amplifier has a digital display and programming buttons underneath a clear plastic cover. The RS-232 module, which sits on top of the laser amplifier, has an R/RW switch, a terminal strip, and dip switches.

To separate the two modules, pull them straight apart.

NOTICE

Keep the modules parallel when disconnecting. Twisting the modules may damage the connector.

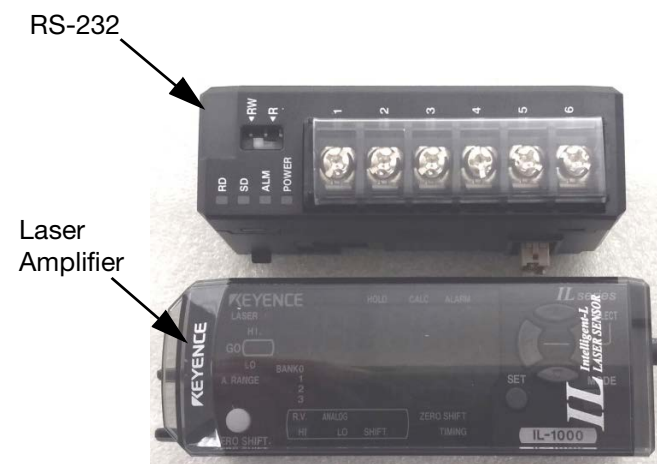

The RS-232 module must be detached from the laser amplifier to access the dip switches. Once they are separated, verify that the six dip switches on the RS-232 module are set correctly. There is a sticker covering the switches that will need to be removed.

Hold the RS-232 module with the terminals facing up and the dip switches facing you to orient the dip switches. Switch 1 is on the left and switch 6 is on the right. All switches should be down (off) except switch 2, which should be up (on).

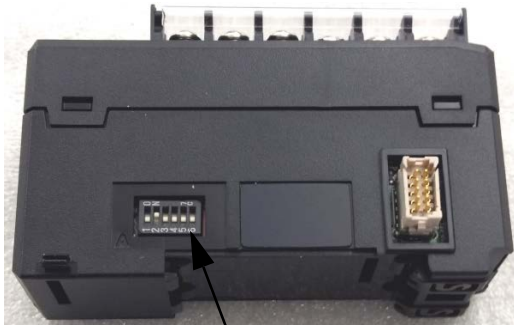

RS-232 Dip Switches

These dip switches set the baud rate to 9600 bits/s, the data bit length to 8 bits, and the parity to none.

Reconnect the two modules and set the laser amplifier parameters as follows.

1. Place the switch on the RS-232 module to the “R” position. This is a temporary setting to allow access to the menu options on the laser amplifier.

NOTE: The switch needs to be set at the “RW” position for normal running.

2. Press and hold the Mode button on the laser amplifier for two seconds to enter the setting mode.
3. Use the right and left buttons to toggle through the list of parameter options (1-18).
4. Verify the following parameter values appear in the digital display:

Parameter	Value
1. dir	nor
2. SPd	dEFLt
3. AuE	16
4. ALn	dEFLt
5. Out	no

5. Use the up and down buttons to change the parameter value if necessary.

6. When the display shows “END,” press and hold the Mode and V buttons for 2 seconds to enter the advanced setting mode. The display should show “PRO.”
7. Using the arrow keys, verify the following parameter values are used.

Parameter	Value
6. HLd	S-H
7. t in	Level
8. dLy	off
9. HyS	0
10. AnG	N/A
11. In	dEFLt
12. bnY	btn
13. SFt	n - off
14. inF	N/A
15. dSP	dEFLt
16. Eco	off
17. HEd	dEFLt
18. CoL	GoGrn

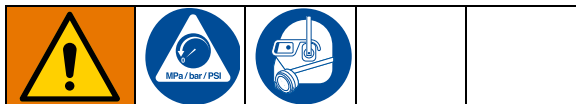

8. Return the switch on the RS-232 module to the “RW” position.

Shutdown



Before shutting down, make sure any parts are removed from the work area.

NOTE: See **Figures 1** and **2** on pages **8** and **9** for location of the UniXact system components.

1. At the Run screen, select the  icon to stop production. See **Operation** on page **59**.
2. Select the  icon at the top of the display to bring the motion table to the maintenance position.
3. Perform the **Pressure Relief Procedure**.
4. Remove the mixer, shut off valve, and needle as applicable.
5. Clean and apply the night cap to the dispense nozzle.
6. Shut down the feed system.

NOTE: For more specific shutdown recommendations, refer to the manual for the dispenser and feed system you are using. See **Related Manuals** on page **3**.

7. Log out of the dispenser software.
8. Close out of any other open programs.
9. Shut down the computer using the Windows Start Menu.
10. Turn off power to the machine by pressing the red control power button on the front of the C-300 (G) or C-500 (AH).
11. Turn off the computer monitor (B - C-300; AB - C-500).
12. Turn off the system power switch (K - C-300; AK - C-500).
13. Close the door if you are using a C-300 with an access door (D).

NOTE: The light curtain turns off and the motors are disabled when the control power is turned off by pressing the red control power button. Power to the control sensors and the system computer remain on to allow for sensor calibration and adjustment.

Pressure Relief Procedure

 Follow the Pressure Relief Procedure whenever you see this symbol.

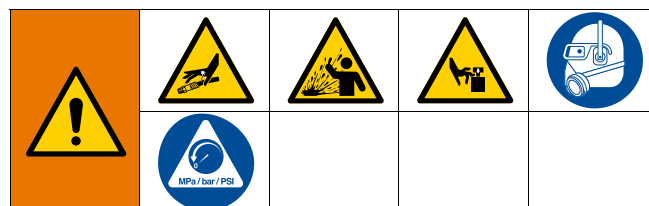

This equipment stays pressurized until pressure is manually relieved. To help prevent serious injury from pressurized fluid, such as skin injection, splashing fluid, and moving parts, follow the **Pressure Relief Procedures** when you stop dispensing and before cleaning, checking, or servicing the equipment.

1. Perform the **Pressure Relief Procedure** recommendations for the dispenser and feed system you are using. See **Related Manuals** on page **3**.
2. Press down the system air pressure slide valve to stop all air supply and to vent air pressure in the machine. It is the yellow tab at the rear of the machine. The hole in the yellow tab should be visible.

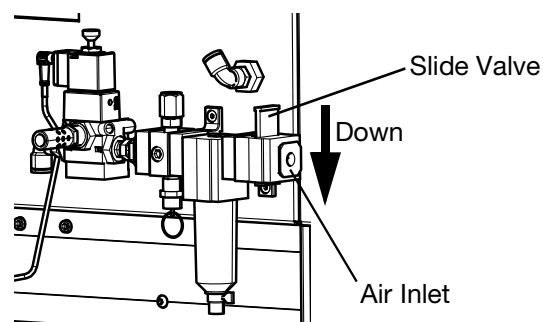
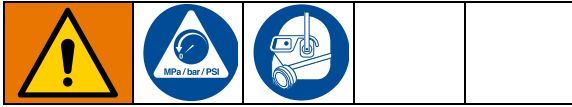

FIG. 15: Pressure Relief

Maintenance



Follow the **Shutdown** procedure as described on page 79 before performing any maintenance on the UniXact machine.

NOTICE

Do not use silicone as a lubricant. Doing so may cause damage to the machine.

NOTE: The drive components on all machines are shipped from the factory with greased ball screws and protective oil coating on the rails. The grease is compatible with DIN 51517T3.

Lubrication Schedule for the Double Rails

The steel shafts in the double rails and linear bearings should be lubricated and protected as follows:

- The rails should be cleaned and lubricated every 8-10 hours if the machine is being used in a dusty environment.
- The rails should be cleaned and lubricated every 100-150 hours if the machine is being run in a relatively clean and dust-free environment.

If the rails appear dirty, wipe them clean before lubricating.

Lubricate the rails with oil that contains both a lubricant and a rust inhibitor. See **Recommended Lubricants** on this page.

Recommended Lubricants

Double rails - Renolin CLP.

Ball screws and carriages - Alvania-1, Alvania-2, Alvania-3 (or equivalent) grease for light, medium, and heavy-duty applications, respectively.

Double Rails Lubrication Steps

1. Apply oil to an acid brush.
2. Spread the rubber guards apart at each of the four locations and brush oil onto the rails. See **Figure 16**.

NOTE: It may be necessary to bend the brush to properly apply the oil.

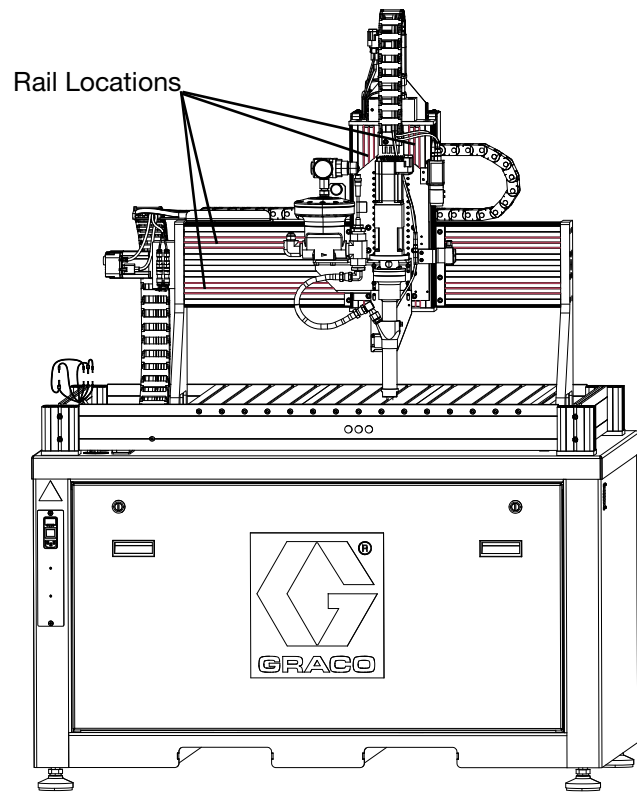

FIG. 16: Rubber Guard and Rail Locations

Lubrication Schedule for the Ball Screw

Lubricate the ball screw after its first 50 hours of service.

Subsequently, lubricate the ball screw:

- Every 20-40 hours of service in a dusty environment.
- Every 300-700 hours in a relatively clean environment.

Ball Screw Lubrication Steps

NOTE: Access to the ball screw is through the rear, lower panel of the machine. See **Figure 18**.

1. Apply grease to a different acid brush than the one used for the double rails.
2. Use a large flat head screw driver or similar tool to turn the two latches on the rear panel 1/4 turn counterclockwise. This will release the panel. See **Figure 17**.
3. Using both handles, remove the rear panel.

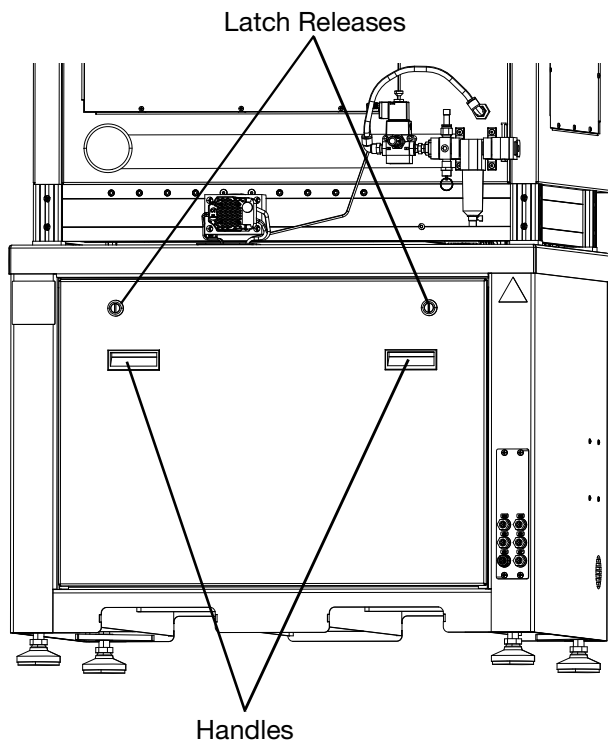

FIG. 17: C-300 Rear Panel

4. Use a Phillips head screw driver to remove the two screws from the small panel covering the ball screw. See **Figure 18**.

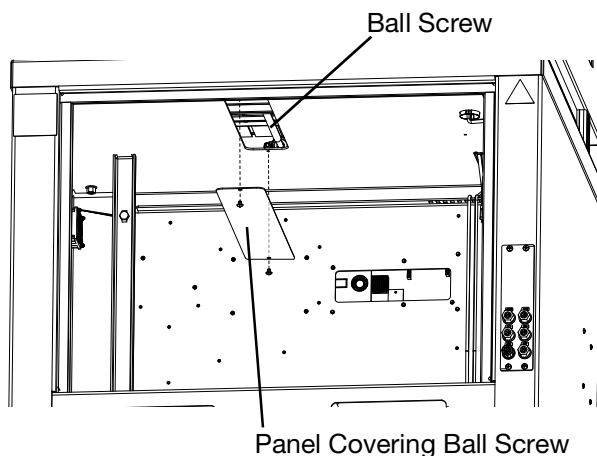

FIG. 18: Remove Ball Screw Cover

5. Apply grease to the ball screw using the acid brush.
6. Replace the small panel with the two Phillips head screws and then replace the rear panel with the flat head screws.

After you have completed lubricating the UniXact machine, restart the system as described in **Startup** on page 13.

Troubleshooting

Before starting any troubleshooting procedures, perform the following procedures. Also refer to the **Related Manuals** on page 3.

1. Verify the system computer is connected (communicating with the controller).
2. Verify there is control power on the machine (the on/off button light is illuminated).
3. Check the machine status messages for alarms. Press the clear alarms icon to clear all alarms that are not active. The remaining alarms will help to identify the issue.

Problem	Cause	Solution
The shape of the pattern dispensed does not match the programmed pattern.	One axis may not be moving at the requested velocity because the program is calling for a velocity higher than the limit established in the parameters.	Parameter settings for running rate should be equal to or greater than the velocity called for in the program. Adjust the program or parameter settings so the above statement is true.
A slide is locked in but the machine will not run a part.	The sensor on the locking cylinder that holds the slide in is faulty or out of calibration.	Adjust the sensor so it changes the state when the slide is locked in.
The machine can be jogged but it will not come to the maintenance position when the maintenance icon is selected.	The system needs to be homed.	Home the system.
The dispense tip is scraping on the part.	The Z-offset was applied but not enabled. The needle find was not performed or the needle is dirty. The fixture moved or is out of calibration. The part is not seated properly or is out of spec.	Verify the offset is enabled. Verify the needle find is enabled. Inspect the needle for dirt. Install a new needle and home the system. Verify the part is seated correctly. Inspect the fixture and make sure the part is secure and in spec.
The system does not home.	No control power. Not connected to the controller. Sitting on an over-travel limit. Wrong dispense valve is selected or valve is installed incorrectly.	Turn on the control power. Connect to the controller. Center the axis (off of all limits) before attempting to re-home. Home the system. Verify that the selected dispense valve in the software matches the installed hardware. Verify that the valve switches are positioned and functioning properly.
Low pressure alarm or slow pressure rise on one or both sides.	Valve not reloading properly. Air trapped in valve. Feed system issue.	Inspect feed system. Check for piston failure if cartridge feed. Check for inadequate material flow at valve. Purge air from the metering system. See the metering system manuals.

Problem	Cause	Solution
Dispense axis is stopped on plus limit.	<p>Attempted to dispense a shot or series of shots in excess of the valve output capacity.</p> <p>Limit sensor improperly calibrated.</p>	<p>Adjust the program to dispense an amount within the valve shot limit.</p> <p>Check positioning of valve over-travel switches.</p>
Dispense motor faults or valve does not dispense.	<p>Over pressure under pressure faults.</p> <p>Valve outlet is obstructed.</p> <p>Excessive flow rate.</p>	<p>Replace the mixer.</p> <p>Check that the valve outlet flows freely.</p> <p>Check the analog settings and calibration for pressure switches.</p> <p>Check for binding condition in the dispenser.</p>
Dispense Motor Axis Fault	<p>Incorrect dispense valve parameters.</p> <p>Faulty motor.</p>	<p>Verify correct valve is selected and valve parameters are correct.</p> <p>Verify dispense rate is appropriate for valve and material.</p> <p>Verify motor is operating within range; consider valve output per revolution, dispense rate, and gear reduction.</p>
Part program runs in a continuous loop without stopping	<p>Part in Fixture sensor is disabled.</p>	<p>Enable the Part in Fixture sensor in the parameters OR add a Wait for Input as the first command of the program with an input address for a start device.</p>
Part program runs but the command list does not appear in the command window on the Run screen	<p>The program is saved to the motion controller but is not located in the current Save directory established in the General System Parameters.</p>	<p>Change the Save directory to the location containing the program file or copy the program file into the current Save directory.</p> <p>NOTE: The machine operation is not affected by this so it is not required that you take any action.</p>
Part program runs in wet mode but does not dispense	<p>Material supply issue.</p> <p>Valve malfunction.</p> <p>Corrupt valve parameters.</p> <p>Missing Dispense On command in part program or no Dispense Rate.</p>	<p>Verify the feed system is functioning and has sufficient material.</p> <p>Verify the dispense valve operation.</p> <p>Verify and save the Valve parameters.</p> <p>Change to a different valve type, save it, and then change back to the correct valve type to reload the complete parameter list.</p> <p>Verify the program contains a Dispense On command and appropriate Dispense Rate.</p>

Problem	Cause	Solution
Program is not compiled with current dispense valve (error message)	Selected programs for all nests must be downloaded with the correct dispense valve selected.	<p>Verify the correct dispense valve is selected in the parameters.</p> <p>Open the programs selected on the Run screen; save and download them.</p>
PC screen is blank but there is power on the machine and the monitor	<p>No power to PC.</p> <p>PC was shut down or put to sleep.</p> <p>Faulty PC.</p>	<p>If the PC is shut down or put to sleep, it is necessary to cycle power to the system to restart the PC.</p> <p>If the PC is sleeping, it may be possible to wake it up with a keyboard or mouse, depending on the PC settings.</p>
Axes do not go to the taught position or the taught position does not match the current position	<p>Position of axes when teaching was outside the machine limits defined in the parameters.</p> <p>Teaching a parameter location when the axes are located outside the machine limits causes the teach point to be adjusted to the closest position to the teach point that is within the limits.</p>	Adjust the machine limits to include the full range motion for the axes and then reteach the point.
Machine starts to run a part but stops at the point the dispense should begin	<p>Dispense valve malfunction.</p> <p>Valve waiting for input to sequence properly.</p>	<p>Check valve input/output.</p> <p>Verify air pressure is on the valve.</p> <p>Verify all sensors are activating.</p> <p>Verify sensors are positioned properly.</p>
Machine does not function when power is on	<p>Emergency stop button is engaged.</p> <p>No control power.</p>	<p>Verify the e-stop button is disengaged.</p> <p>Verify the light curtain is not interrupted (if equipped).</p> <p>Verify the safety switch on the door is engaged (if equipped).</p> <p>Press the green power button (the control power light in the button cluster should be illuminated).</p>

Problem	Cause	Solution
Unexpected error messages or erratic behavior of dispenser software	Corrupt parameter files. Corrupt database files. Incorrect parameters.	Power down the system from the main system power switch, then restart. Rename the database file “Db.s2db” to preserve data. A new file is created when the system is restarted (the file is located in c:\graco). Rename the “Params.cfg9” file to preserve data. A new file is created when the system is restarted (the file is located in c:\graco). Then re-enter the parameters. NOTE: The old parameters file can be opened in WordPad to view previous settings.
The mute function on the light curtain does not activate between parts	The Part Load feature is not enabled in the parameters. The axes are not positioned to activate the load/reload position sensors. Faulty position sensor.	Verify the Part Load is enabled in the parameters. Verify switches are positioned to activate in the taught Part Load position. Verify the function of each switch.
When jogging an axis, it only moves in one direction	The axis is located at the end of the travel position (over travel switch is activated). Failed over-travel switch. Mechanical obstruction.	Verify the axis is positioned between the limits. If the limit is active with the axis in this position, replace or service the limit sensor. Verify switch operation on the Maintenance Input/Output screen. The over-travel switch indicates red until the switch is activated at the end of travel. Then it should turn green.
Z-axis limit exceeded on program that previously ran without issue	The offset value on the Run screen may have been increased. The calculated maximum Z jump height allows for an offset of about 1.75 without faulting.	Reduce jump height OR Adjust the Z height in the program so the offset on the Run screen can be reduced.
Slide will not lock in and part will not run in Run mode Locking pin fires and immediately retracts	The locking pin sensor is out of calibration or has failed. The part program is corrupt.	Manually toggle the slide lock and verify that the locking pin sensor LED is illuminated and that the locking pin input changes its state. Re-download the program and attempt running again.
Motion controller randomly disconnects from the computer Cannot find IP address	Power interruption or SV power supply output voltage is adjusted too low	Verify output from 5 VDC supply is between 5.1 and 5.2 volts. Voltage can be adjusted with potentiometer on the power supply. Do not adjust above 5.2 volts.

Input/Output Test Procedure

Verifying inputs and outputs is done at the Maintenance screen. See **Input/Output Information** on page 18. These procedures can also be performed when troubleshooting the system.

INPUTS	Procedure to Test
Slide Left	<p>Push in the left slide until it stops and then slightly back and forth against the stop. The slide left indicator should toggle green/red.</p> <p>When the left slide is pushed fully in, the Slide Left input should indicate green. NOTE: This input device is normally closed (N/C), the status bit is inverted.</p>
Slide Right	<p>Push in the right slide until it stops and then slightly back and forth against the stop. The Slide Right indicator should toggle green/red.</p> <p>When the right slide is pushed fully in, the slide right input should indicate green. NOTE: This input device is N/C, the status bit is inverted.</p>
Reload CSV (PD44, 1053, 1093 Spool Position Sensor)	<p>Toggle the output for dispense (output 4) on and off from the I/O screen should cause the reload CSV status indicator to toggle green/red.</p> <p>When the output for the dispense indicator is red, the reload CSV input should indicate green. NOTE: This input device is N/C, the status bit is inverted.</p>
Dispense OSV (PD44, 1053, 1093 Spool Position Sensor)	<p>Toggle the output for dispense (output 4) on and off from the I/O screen should cause the Slide Right status indicator to toggle green/red.</p> <p>When the output for the dispense indicator is green, the dispense OSV input should indicate green. NOTE: This input device is N/C, the status bit is inverted.</p>
Part Present	<p>NOTE: The dispenser must be located in the taught position. See: Calibrate the Part Present Sensor Option on page 71.</p> <p>This device (if equipped) is always active but requires calibration. If properly calibrated, sliding a part in and out of the dispense position will toggle this input on and off. When a part is on the slide in the lock position this input will be green.</p>

Motion Power	<p>If the PC is on, but there is no control power (the red control power button has been pressed), status is red.</p> <p>If the PC is on, and there is control power (the green control power button has been pressed), status is green.</p>
Dispense Power	<p>This will operate in parallel to Motion Power – except dispense power remains lit (green) if the door is opened while in the maintenance position.</p>
Locking Pin Left	<p>Toggle output 1 on and off should cause the Locking Pin Left status indicator to toggle green/red.</p> <p>When the output for Locking Pin Left indicator is green, Locking Pin Left input should indicate green.</p>
Locking Pin Right	<p>Toggle output 2 on and off should cause the Locking Pin Right status indicator to toggle green/red.</p> <p>When the output for Locking Pin Right indicator is green, Locking Pin Right input should indicate green.</p>
Part in Fixture	<p>Install the part in the dispense position to activate the switch.</p> <p>When the part is in place, the input should indicate green. NOTE: This input device is N/C, the status bit is inverted.</p>
PR70 Fault	<p>The PR70 must be connected to the dispense table to test. On the PR70, initiate a low level alarm (remove a low level sensor if the PR70 has level sensors; activate level controls if the PR70 does not have level controls). Toggling the level alarm on turns the status indicator red.</p>
PR70 Ready	<p>The PR70 must be connected to the dispense table to test. On the PR70 ADM, toggle the PR70 from disabled mode to shot mode. In shot mode, the status indicator should be green. In disabled mode, the status indicator should be red.</p>
Cycle Start	<p>Press the start device and the status bit should turn green momentarily. NOTE: This depends on the start device. The signal may be momentary or constant if the start device is held down.</p>
OUTPUTS	Procedure to Test
<p>NOTE: Outputs can be turned on and off manually by clicking on the green/red status indicator to the right of each output name. If the indicator is green and does not toggle off when it is selected, it is being held on by the software and cannot be turned off in this manner.</p>	
Slide Lock Left	<p>Select the indicator to the left of the Dispense label. The locking air cylinder for the left slide should activate.</p>

Slide Lock Right	Select the indicator to the right of the Slide Lock Right label. The locking air cylinder for the right slide should activate.
Blow Off	Select the indicator to the right of the Blow Off label. Air should blow from the purge fixture (if equipped).
Dispense	Select the indicator to the left of the dispense label (the resulting action varies depending on the dispense valve). NOTICE: Toggling this output may result in material being dispensed, which could cause damage to the equipment. This output should be tested without material in the dispenser <i>When using a PD44 dispense valve:</i> The spool valve should shift and the shut off valve should rotate. If the status indicator is green: the slot in the shutoff coupling should be horizontal, Reload CSV status should be red, and Dispense OSV status should be green.
Tick Tock (16)	Tick Tock bit (toggles approximately every 1.6 sec).
LIMITS	Procedure to Test
NOTE: The maximum jog rate is controlled by the Jogging parameters on the Maintenance screen. It is recommended that all of the jog rates be set to a value of 5 (especially on the Z axis) until the operator is comfortable with jogging the system.	
X Plus Limit	Jog the X axis to the right until it stops. Jogging back and forth, on and off of this stopped position causes the X plus limit indicator to toggle on and off. When the X axis is in the rightmost position, the X plus indicator should be green.
X Minus Limit	Jog the X axis to the left until it stops. Jogging back and forth, on and off of this stopped position causes the X minus limit indicator to toggle on and off. When the X axis is in the leftmost position, the X minus indicator should be green.
X Home Limit	Not used.
X Needle Find	Activate the X-axis needle find sensor by blocking the sensor beam. When the beam is blocked, the X-needlefind status should be green.
Y Plus Limit	Jog the Y axis forward (away from the operator) until it stops. Jogging back and forth, on and off of this stopped position causes the Y plus limit indicator to toggle on and off. When the Y axis is in the forward most position, the Y plus indicator should be green.

Y Minus Limit	Jog the Y axis backward (towards the operator) until it stops. Jogging back and forth, on and off of this stopped position causes the Y minus limit indicator to toggle on and off. When the Y axis is in the backward most position, the Y minus indicator should be green.
Y Home Limit	Not Used.
Y Needle Find	Activate the Y-axis needle find sensor by blocking the sensor beam. When the beam is blocked, the X-needlefind status should be green.
Z Plus Limit	Jog the Z axis up until it stops. Jogging up and down, on and off of this stopped position, causes the Z plus limit indicator to toggle on and off. When the Z axis is in the upper most position, the Z plus indicator should be green.
Z Minus Limit	NOTICE: Jogging this axis to the limit may cause the dispenser to crash into a part or fixture. You should test this limit in the home position, with the mixer and needle removed. Jog the Z axis down until it stops. Jogging up and down, on and off of this stopped position, causes the Z minus limit indicator to toggle on and off. When the Z axis is in the lower most position, the Z minus indicator should be green.
Pitch and Roll Sensor	NOTE: The pitch and roll sensor (touch sensor) is optional, and this sensor is not used during normal operation. See Appendix D: Touch Sensor Installation on page 98 for more information. Pressing the pitch and roll sensor button on and off with your finger will cause the pitch and roll sensor status indicator to toggle red/green. When the pitch and roll sensor is pressed the pitch and roll status indicator should be green. NOTE: This input device is N/C, the status bit is inverted.
Z User Limit	Not Used.

<p>Dispenser Plus Limit</p>	<p>NOTICE: Jogging the dispenser forward when loaded with material may cause equipment damage if the dispenser is wetted with material. These limits should be tested without material in the dispenser.</p> <p>NOTICE: Jogging the dispenser to the limits can cause damage to some valves if the limit sensors are not positioned properly. Verify switch positioning prior to testing.</p> <p>The dispenser can be jogged up or down from the valve tab in the setup window. Path: Maintenance Screen – Parameters – Valve tab.</p> <p><i>When using a PD44 dispense valve:</i></p> <p>Jog the dispenser using the down arrow on the display until it stops. Jogging up and down, on and off of this stopped position, causes the Dispense Plus limit Indicator to toggle on and off.</p> <p>When the dispenser is in the lower most position, the Dispense Plus Limit indicator should be green.</p>
<p>Dispenser Minus Limit</p>	<p>NOTICE: Jogging the dispenser forward when loaded with material may cause equipment damage if the dispenser is wetted with material. These limits should be tested without material in the dispenser.</p> <p>NOTICE: Jogging the dispenser to the limits can cause damage to some valves if the limit sensors are not positioned properly. Verify switch positioning prior to testing.</p> <p>The dispenser can be jogged up or down from the valve tab in the setup window. Path: Maintenance Screen – Parameters – Valve tab.</p> <p><i>When using a PD44 dispense valve:</i></p> <p>Jog the dispenser using the up arrow on the display until it stops. Jogging up and down, on and off of this stopped position, causes the Dispense Minus Limit indicator to toggle on and off.</p> <p>When the dispenser is in the upper most position, the Dispense Minus Limit indicator should be green.</p>

<p>Dispenser Home Limit</p>	<p>NOTICE: Jogging the dispenser forward when loaded with material may cause equipment damage if the dispenser is wetted with material. These limits should be tested without material in the dispenser.</p> <p>NOTICE: Jogging the dispenser to the limits can cause damage to some valves if the limit sensors are not positioned properly. Verify switch positioning prior to testing.</p> <p>NOTE: The speed override slider does not affect the jog speed of the dispenser.</p> <p>The dispenser can be jogged up or down from the valve tab in the setup window. Path: Maintenance Screen – Parameters – Valve tab.</p> <p><i>When using a PD44 dispense valve:</i></p> <p>From the uppermost position, jog the dispenser down about 5 mm using the down arrow on the valve tab. Watch the LED's on the side of the PD44 as the axis indexes down. The upper limit should turn red first, followed by the home limit when indexing down.</p> <p>Jog the dispenser up using the up arrow on the valve tab. Watch the LEDs on the side of the PD44 as the axis indexes up. The LED on the home limit should go out first, followed by the plus limit when indexing up.</p> <p>Jog down until the home sensor LED turns red – The dispenser home limit indicator should be red.</p> <p>Jog back up until the home sensor LED goes out – The dispenser home limit indicator should be green.</p>
<p>Dispenser User Limit</p>	<p>Not Used.</p>

Safety Circuit Design



Part Access Door

Systems equipped with an access door are designed to prevent access into the work area while the machine could be running. Opening the door disables the axis motors. However, if the machine is parked in the maintenance position, the door can be opened and the dispense axis remains enabled.

Light Curtain

Systems equipped with a light curtain are designed to disable the machine if you attempt to enter the work area while the machine is running. Interrupting the light curtain disables the axis motors. However, if the machine is parked in the maintenance position, you can enter the work area and the dispense axis remains enabled.

Safety Circuit Activation Recovery

If the door is opened or the light curtain is interrupted while the system is running, the safety circuit is activated and the machine acts the same as if the emergency stop was pressed. Dispensing stops, motion stops, and the control power to the motors is cut. To recover from this:

1. Remove the aborted part.
2. Clean the dispense tip of any material or replace it.
3. Close the door or clear the light curtain.
4. Press the control power on button.
5. Home the system.
6. Purge the mixer if necessary.
7. Resume production.

Maintenance Position

This is a dispenser position defined by X, Y, and Z coordinates saved in the parameters. The coordinates of the maintenance position are chosen so that sensors verify the X, Y, and Z position. When the machine is indexed to this position and these switches are activated, the safety circuit is disabled to allow you to enter the work area to operate and maintain the dispense valve. Any X, Y, or Z motion would cause the safety circuit to activate and shut down the system when you are operating in the work area. The machine can be sent to this position automatically by pressing the maintenance position button.

Part Load/Unload Position

NOTE: This feature is only for systems with light curtains. It is not available on systems with an access door.

This is a dispenser position defined by X, Y, and Z coordinates saved in the parameters. Axes positions are verified by proximity switches. The switch positions are chosen such that the dispenser is out of the way to allow the necessary access for loading and unloading parts. This position may also double as the purge location. When the machine is indexed to this position and these switches are activated, the light curtain can be broken without activating the safety circuit. The machine automatically goes to this position when the Run icon is pressed.

When this feature is enabled, the axes automatically index to this location when the machine is placed in Run mode after a part is completed.

When the light curtain is interrupted while the machine is in the Part Load/Unload position, it does not affect the machine. Moving the machine from this position activates the safety circuit.

Safe Part Removal

Dual-Y Slide with Access Door: The slide assembly facilitates loading and unloading the parts outside of the work area. There is no need to open the access door during production.

Light Curtain: The part program must send the dispenser to the Part Load/Unload (safe) position. The light curtain is muted to load or unload parts without the safety circuit being activated while in this position.

Error/Event Alarms

The table below details the alarm text, the cause of the alarm, and the name of the alarm bit.

NOTE: When you have resolved the cause of an alarm, you still need to clear the alarm message on the Alarm window to remove it. See **System and Alarm Status** on page 61.

Alarms that occur during purging or dispensing require the alarm to be acknowledged before the system can continue to purge or dispense. Motion alarms require the system to be homed before running can proceed. If an alarm occurs while a part is being run, the part is canceled and the system moves out of run mode.

Error Message	Cause	Error Type
No Motion Power.	One or more motors currently do not have motion power.	Alarm
X Axis stopped on plus limit switch.	The x axis has encountered the positive travel limit.	Alarm
X Axis stopped on minus limit switch.	The x axis has encountered the negative travel limit.	Alarm
X Axis home not complete.	The x axis needs to be re-homed.	Alarm
X Axis fatal following error or position error.	The following error on the x axis has become too great for the system to proceed.	Alarm
X Axis motor fault.	The x axis motor has faulted (this alarm will occur when the system is e-stopped).	Alarm
Y Axis stopped on plus limit switch.	The y axis has encountered the positive travel limit.	Alarm
Y Axis stopped on minus limit switch.	The y axis has encountered the negative travel limit.	Alarm
Y Axis home not complete.	The y axis needs to be re-homed.	Alarm
Y Axis fatal following error or position error.	The following error on the y axis has become too great for the system to proceed.	Alarm
Y Axis motor fault.	The y axis motor has faulted (this alarm will occur when the system is e-stopped).	Alarm
Z Axis stopped on plus limit switch.	The z axis has encountered the positive travel limit.	Alarm
Z Axis stopped on minus limit switch.	The z axis has encountered the negative travel limit.	Alarm
Z Axis home not complete.	The z axis needs to be re-homed.	Alarm
Z Axis fatal following error or position error.	The following error on the z axis has become too great for the system to proceed.	Alarm
Z Axis motor fault.	The z axis motor has faulted (this alarm will occur when the system is e-stopped).	Alarm
Dispenser Axis stopped on plus limit switch.	The dispenser axis has encountered the positive travel limit.	Alarm
Dispenser Axis stopped on minus limit switch.	The dispenser axis has encountered the negative travel limit.	Alarm
Dispenser Axis home not complete.	The dispenser axis needs to be re-homed.	Alarm
Dispenser Axis fatal following error or position error.	The following error on the dispenser axis has become too great for the system to proceed.	Alarm
Dispenser Axis motor fault.	The dispenser axis motor has faulted (this alarm will occur when the system is e-stopped).	Alarm
Pressure 1 High Alarm while dispensing.	At some point during dispensing, the analog 1 input was higher than the amount specified by the Analog 1 Max Dispense Alarm parameter.	Alarm
Pressure 1 Low Alarm while dispensing.	At some point during dispensing, the analog 1 input was lower than the amount specified by the Analog 1 Min Dispense Alarm parameter.	Alarm
Pressure 1 High Alarm while purging.	At some point during purging, the analog 1 input was higher than the amount specified by the Analog 1 Max Purge Alarm parameter.	Alarm

Error Message	Cause	Error Type
Pressure 1 Low Alarm while purging.	At some point during purging, the analog 1 input was lower than the amount specified by the Analog 1 Max Purge Alarm parameter.	Alarm
Pressure 2 High Alarm while dispensing.	At some point during dispensing, the analog 2 input was higher than the amount specified by the Analog 1 Max Dispense Alarm parameter.	Alarm
Pressure 2 Low Alarm while dispensing.	At some point during dispensing, the analog 2 input was lower than the amount specified by the Analog 2 Min Dispense Alarm parameter.	Alarm
Pressure 2 High Alarm while purging.	At some point during purging, the analog 2 input was higher than the amount specified by the Analog 2 Max Purge Alarm parameter.	Alarm
Pressure 2 Low Alarm while purging.	At some point during purging, the analog 2 input was lower than the amount specified by the Analog 2 Max Purge Alarm parameter.	Alarm
Pressure 1 High Warning while dispensing.	At some point during dispensing, the analog 1 input was higher than the amount specified by the Analog 1 Max Dispense Warn parameter.	Warning
Pressure 1 Low Warning while dispensing.	At some point during dispensing, the analog 1 input was lower than the amount specified by the Analog 1 Min Dispense Warn parameter.	Warning
Pressure 1 High Warning while purging.	At some point during purging, the analog 1 input was higher than the amount specified by the Analog 1 Max Purge Warn parameter.	Warning
Pressure 1 Low Warning while purging.	At some point during purging, the analog 1 input was lower than the amount specified by the Analog 1 Max Purge Warn parameter.	Warning
Pressure 2 High Warning while dispensing.	At some point during dispensing, the analog 2 input was higher than the amount specified by the Analog 1 Max Dispense Warn parameter.	Warning
Pressure 2 Low Warning while purging.	At some point during purging, the analog 2 input was lower than the amount specified by the Analog 2 Max Purge Warn parameter.	Warning
Pressure 2 Low Warning while dispensing.	At some point during dispensing, the analog 2 input was lower than the amount specified by the Analog 2 Min Dispense Warn parameter.	Warning
Pressure 2 High Warning while purging.	At some point during purging, the analog 2 input was higher than the amount specified by the Analog 2 Max Purge Warn parameter.	Warning
Needle Find Fault. Unable to find the needle.	The needlefind routine was unable to find the needletip.	Alarm
Dispenser Solenoid On/Off TimeOut.	Input 3 (default Reload CSV) did not turn on or Input 4 (default Dispense OSV) did not turn off as expected.	Alarm
Move Time Out.	Part of the homing routine has taken too long to complete.	Alarm
Touch Routine Fault. Did not touch nest.	The system moved the maximum distance during the calibration touchdown routine and did not see the touch sensor activate.	Alarm
Touch Routine Fault. Missing sensor or sensor already tripped.	The system attempted to perform the calibration touchdown routine while the touch sensor was already active.	Alarm
PR70 Valve Fault	Message generated by the Fault Output from the PR70. Used to trigger input 13 (IN 2 on the I/O expansion board).	Alarm

Error Message	Cause	Error Type
Alarm - Low Inlet Pressure Sensor 1	At some point while the machine was running, the analog 1 input was lower than the amount specified by the Analog 1 Min. Dispense Alarm parameter. The PCP valve must be selected for this input to function as an inlet alarm rather than a dispense alarm.	Alarm
Alarm - High Inlet Pressure Sensor	At some point while the machine was running, the analog 1 input was higher than the amount specified by the Analog 1 Max. Dispense Alarm parameter. The PCP valve must be selected for this input to function as an inlet alarm rather than a dispense alarm.	Alarm
Alarm - Wait for Input Timeout	Wait for the input command: the input address did not change the state within the allotted time (timeout value).	Alarm
Alarm - Material A Level Error	Message generated by triggering input 12 (P20 on the controller interface board). The message remains until the input is cleared.	Alarm
Alarm - Material B Level Error	Message generated by triggering input 16 (IN 5 on the I/O expansion board). The message remains until the input is cleared.	Alarm
Alarm - Vision Timeout	The camera failed to find the taught fiducial.	Alarm
Alarm - Vision Cal. Incomplete	The system needs to be re-homed to calibrate the camera.	Alarm
Alarm - Vision Cal. Timeout	The camera failed to find the calibration dot during the home routine.	Alarm
Alarm - Laser Response Timeout	A consistent measurement could not be found during laser measurement. And unmeasurable condition exists.	Alarm
Alarm - Laser Distance Out of Bounds	The laser is located out of range with respect to the target.	Alarm
Alarm - Barcode Scan Timeout	No barcode was found when scanning.	Alarm
Warning - Low Inlet Pressure Sensor 1	At some point while the machine was running, the analog 1 input was lower than the amount specified by the Analog 1 Min. Dispense Warning parameter. The PCP valve must be selected for this input to function as an inlet alarm rather than a dispense alarm.	Warning
Warning - High Inlet Pressure Sensor 1	At some point while the machine was running, the analog 1 input was higher than the amount specified by the Analog 1 Max. Dispense Warning parameter. The PCP valve must be selected for this input to function as an inlet alarm rather than a dispense alarm.	Warning
Warning - Material A Low	Message generated by triggering input 6 (IN 1 on the I/O expansion board). The message remains until the message is cleared.	Warning
Warning - Material B Low	Message generated by triggering input 15 (IN 4 on the I/O expansion board). The message remains until the message is cleared.	Warning
Warning - Maintenance cycle Count Reached	The accumulated value of the Total Cycles has exceeded the Cycles to PM parameter.	Warning

Appendix A: User Access Levels

The following table shows the different system operations that can be performed at each level of user access.

Operator	Technician	Engineer
Connecting to Controller	Connecting to Controller	Connecting to Controller
Go to Maintenance Position	Disconnecting from Controller	Disconnecting from Controller
Dispense Test Shot	Go to Maintenance Position	Go to Maintenance Position
View SPC Statistics	Jog System	Upgrade/Reinstall Controller Files
Select Programs	Dispense Test Shot	Jog System
Run Programs	View I/O Status	Dispense Test Shot
Home System	Toggle I/O	View I/O Status
Initiate Manual Purge	Edit System Parameters	Toggle I/O
View Current Alarms	View SPC Statistics	Edit System Parameters
Clear Alarms	Select Programs	Edit Valve Parameters
	Run Programs	View SPC Statistics
	Home System	Reset SPC Statistics
	Initiate Manual Purge	Create Programs
	Toggle Purge Mode (Manual/Auto)	Edit Programs
	Toggle Run Mode (Wet/Dry)	Select Programs
	View Current Alarms	Run Programs
	Clear Alarms	Single-Step Programs
		Home System
		Initiate Manual Purge
		Toggle Purge Mode (Manual/Auto)
		Toggle Run Mode (Wet/Dry)
		Change Global Z-Offset
		Run System in Single-Step Mode
		View Current Alarms
		Clear Alarms

Screen 6

NOTE: While operators are able to connect to the machine's controller, technician level access is required to disconnect from a controller. Because the software is only able to connect to one controller at a time, if the system is already connected, operators are not able to change the controller to which the software is connected.

Appendix B: Palletize Example

NOTE: You should only use programs that are specifically created to use with the Palletize feature. Attempting to use the Palletize command with a general program results in a number of wasted jump motions.

A typical program for a part begins with a Jump to Position command from the origin of the nest to the start point of the part.

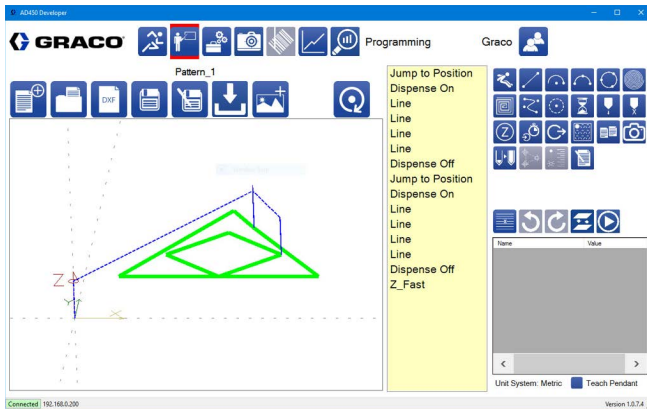

The Palletize command replicates this jump, as well as adding jumps between parts. In screen 2 below, these jumps are two different heights, showing that two jumps are made between each instance of the part.

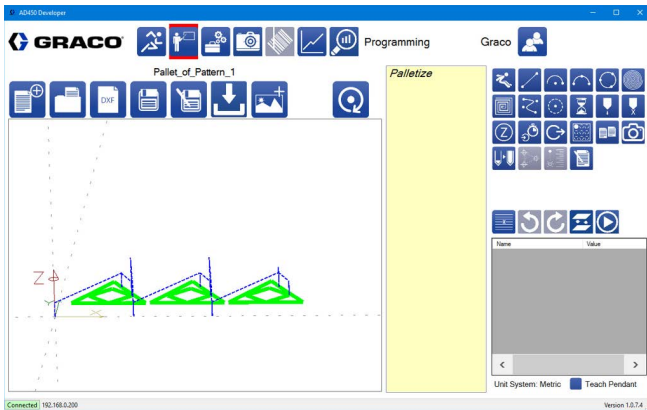

To change the starting point and eliminate extra jumps, move the axes to the starting point of the part and

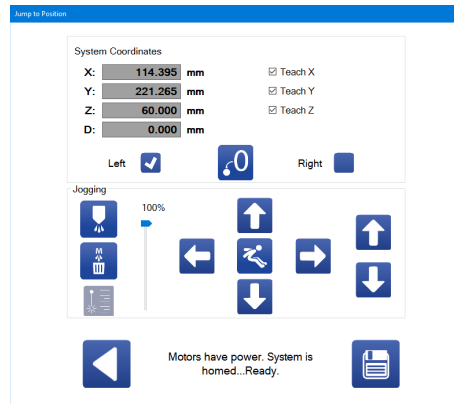

select the  icon. This sets the coordinates for the part's starting point to zero and teaches the part as if the starting point of the part was the origin of the nest.

Screen 3 shows the actual nest coordinates at the starting point of the program.

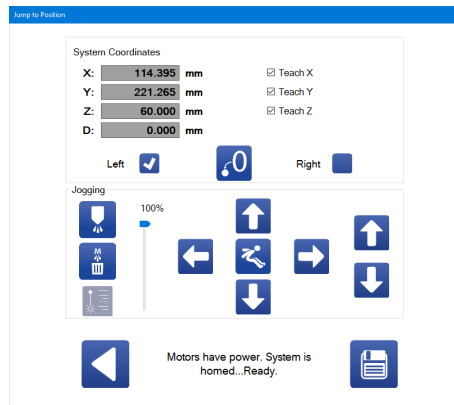

Screen 4 below shows the starting point after the current coordinates have been set to zero.



NOTE: When the  icon is selected, it changes to the  icon. When selected, the  icon reverts the system to the original mode.

With the current coordinates set to zero, a part that had previously required a jump to get to the first position can be taught without that first jump while still using the teach pendant.

In screen 5 below, a new pattern is started at the beginning of the part using the zero here function.

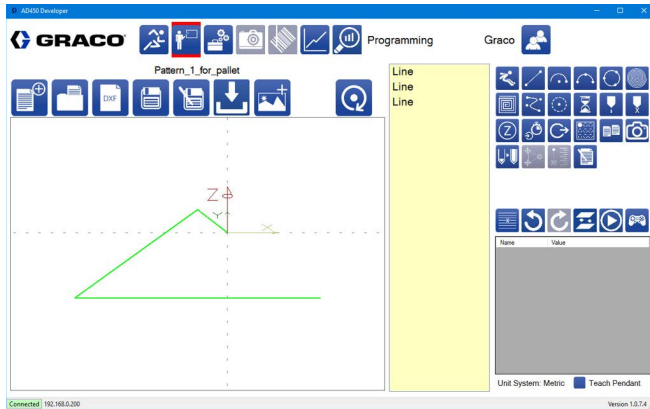

Comparing screen 6 below to screen 1 on page 94, note that there is no Jump to Position command at the start of the part.

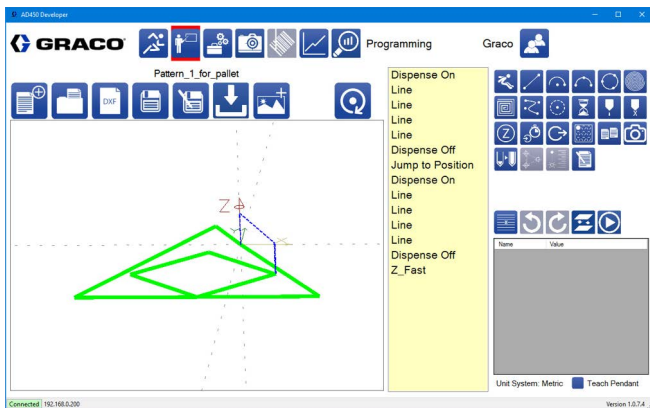

When you are saving a part to be used with the palletize feature, it should be titled appropriately to distinguish it from parts that can be run on the machine normally.

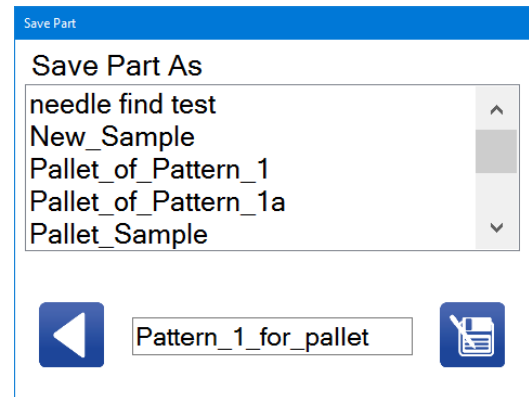

You can select the part to use in a Palletize command with the desired number of rows, columns, and spacing.

Screen 8 shows that there is an additional Jump to Position command before the Palletize command to locate the first part in the pallet. Because the origin of the part has been relocated to be on the part, the extra jump between each part (as shown in screen 1) is eliminated.

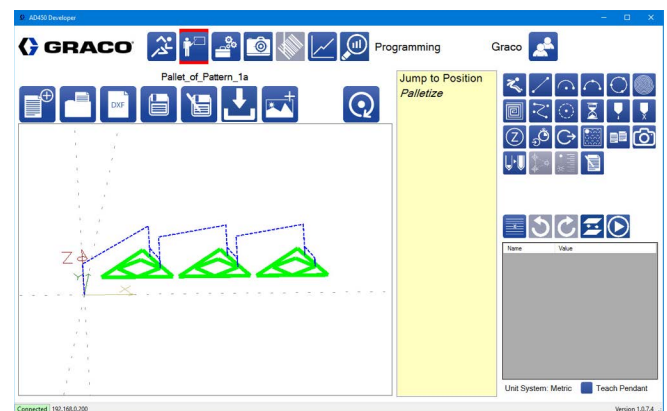

Appendix C: Parameters File

The UniXact software automatically generates a parameters file if it cannot be found. The values in the parameters file can be changed in the parameters, but advanced users may find it helpful to be able to edit the parameters file directly.

NOTE: The parameters file is stored on the local computer and can be most easily accessed using the backup and load functions in the parameters. Values changed in the parameters file are written to the motion controller upon connection when loading a parameters file.

Version Number

The version number is listed at the top of the parameters file. This version number is checked against the version number expected by the software each time a controller is connected to the system. If the version number does not match, the parameters file regenerates with the values from the original file copied over. If changing the parameters file, make sure the version number is correct.

Records

The first section of the parameters file contains the recorded values used during the calibration routine. These parameters cannot be changed in the parameters and do not impact the functionality of the system. These parameters also do not have additional data beyond the recorded values.

Values

Following the records section are the values for all other parameters. Parameter values can be changed directly through this section, which has the same effect as changing them in the parameters. The name of the parameter is separated from the parameter value by an equals sign. The values are broken out according to which section the associated parameters are in.

Parameter Information

Following the values are sections containing the information used to build the parameters list and use the parameters. Each parameter has a number of values associated with it, delineated by commas. The name of the parameter is separated from the parameter information by an equals sign. Parameter information occurs in the following order.

Type of parameter: String values are represented by a text box on the parameters list. Number values provide a numeric text box. Boolean values are represented by a check box. Combo values have a drop-down list.

The controller for the parameter: If this value is Delta Tau, changing this parameter in the parameters causes the parameter to be sent to the motion controller using the corresponding address value. These values are also sent to the controller on connection to the system.

The address to send the value to: If the controller is not Delta Tau, then this value is not used.

The default value for the parameter: This value is used if the actual value is missing or invalid.

The units for the parameter: The units are displayed in the parameters. If the units are mm, mm/s, or mm/s², the system converts the parameter to and from inches if the system is in Standard mode instead of Metric mode.

The following information depends on the type of parameter.

For Strings and Booleans:

The user level: The user level indicates the minimum user access level in order to see or change the parameter. Operators have an access level of 100, technicians have an access level of 500, and engineers have an access level of 2000.

For Numbers:

The minimum value the parameter can have: If the value is less than this, the value is set to the minimum.

The maximum value the parameter can have: If the value is greater than this, the value is set to the maximum.

The number of decimal places to display the parameter in the parameters screen.

The user level: The user level indicates the minimum user access level in order to see or change the parameter. Operators have an access level of 100, technicians have an access level of 500, and engineers have an access level of 2000.

For Combos:

The user level: The user level indicates the minimum user access level in order to see or change the parameter. Operators have an access level of 100, technicians have an access level of 500, and engineers have an access level of 2000.





The sequential options on the drop-down menu.

Parameter Descriptions

The last section of the file contains the descriptions for each parameter. The descriptions for the parameters are displayed at the bottom of the parameters screen when the parameter is selected. Parameters are not required to have a description, and are separated from the description by an equals sign.

Appendix D: Touch Sensor Installation

This procedure is for installing the touch (pitch and roll) sensor for fixture calibration. Prior to installation of the touch sensor, the needle find function needs to be calibrated for use with the selected needle. Offsets must be set to zero to allow calibration of the touch sensor.

1. Select  to open the Maintenance screen.
2. Select  to go to Parameters.
3. Scroll down the parameters list to the Needle Find section and select to disable it.
4. Select the  icon to go to the Run screen.
5. Select the  icon to home the system.
6. Select the  icon to go to the maintenance position.
7. Install the touch sensor assembly - PD44 with shut-off.
 - a. Remove the shut off valve cover.
 - b. Install a mixer and shutoff valve. make sure there is no needle installed.
 - c. Replace the cover on the shutoff valve assembly with the sensor assembly.
 - d. Plug in the sensor to the receptacle.
 - e. Temporarily secure the wire so that the table can be moved through its full range of motion without the wire getting tangled or damaged.

8. Record the Needlefind parameters for location and offset of the dispense needle. These will be entered later.

Needlefind Tip X Offset	
Needlefind Tip Y Offset	
Needlefind Tip Z Offset	
Needlefind Sensor X Location	
Needlefind Sensor Y Location	
Needlefind Sensor Z Location	

9. Change the offset value to zero and teach the location of the sensor.

NOTE: As an alternate method, if the offset values for the needle are all zero, the position of the sensor could be entered as offsets from the standard needle find position.

Needlefind Tip X Offset	0
Needlefind Tip Y Offset	0
Needlefind Tip Z Offset	0
Needlefind Sensor X Location	
Needlefind Sensor Y Location	
Needlefind Sensor Z Location	

10. After the new position is taught, return to the parameters list to the Needlefind function.
 - a. Verify the new needle find position using the jog function.
 - b. Select to Enable Needle Find.

11. Select the  icon to go to the Run screen.

12. Select the  icon to home the system.

NOTE: Be prepared to abort the routine if the machine does not index to the correct position.

If the machine successfully homes with the needle find active and the sensor installed, the machine is ready for the pitch and roll setup as described in **Calibrate the Machine** on page 66.

Appendix E: Dispenser Integration

General I/O for Integration

System Ready: Output 15 is triggered any time system ready conditions are met. Output 15 on the I/O screen is labeled EXP 4 on the expansion board in the control panel. System ready conditions are:

- System is in Run mode.
- There are no active alarm faults.
- There is not a purge cycle active or pending.

System Fault Output: Output 14 is triggered any time there is an alarm generated. Details of the alarm condition can be viewed in the alarm message bar below the system status bar on the Run screen. Output 14 on the I/O screen is labeled EXP 5 on the expansion I/O board in the control panel. The alarm can only be cleared by correcting the fault condition and selecting the alarm button in the alarm message bar. This opens the Alarm window that allows you to clear all alarms. See **System and Alarm Status** on page 61 for more information.

Cycle Complete: A Cycle Complete output can be added to the end of a program by using the following commands (as one possible example) A different output can be used for each slide.

- Output command - I/O on (select an unused output address.)
- Pause (timer) command - time to hold signal on.
- Output command - I/O off (select the same output that was turned on above).

UniXact with Pneumatic PR70

A pneumatic PR70 is primarily used with a UniXact system for potting or dot applications requiring metered dispense shots. Since the PR70 is pneumatically driven, the rate of dispense is not controlled by the dispense table, but by the regulated air supplied to the PR70.



Control of the dispense rate is not precise, and because the PR70 is a reciprocating piston pump, there is a small delay between the time the start signal is initiated and the time dispense begins.

A HydraCheck cylinder is recommended to add some level of control to the dispense rate. The HydraCheck applies a constant (adjustable) resistance against the air cylinder during the metering stroke. This allows the time it takes to complete a shot to be extended while still maintaining adequate pressure to the air cylinder to overcome friction. Without this device, the necessary air pressure required to overcome friction of the pump may result in a flow rate that is too high for the application.

NOTE: Refer to the PR70 and PR70v with Advanced Display Module Operation and Maintenance Manual 312759 for information about ordering the HydraCheck option with a PR70.

For applications requiring a consistent bead of material, a servo-driven dispenser is suggested. This allows both the motion speed and the dispense rate to be precisely controlled.

PR70 Setup

				
<p>When the The PR70 is powered on, it is fully functional whether or not the UniXact machine is running. Material could still be dispensed from the PR70's valve even if the UniXact machine is powered off. To reduce the risk of skin injection, ensure that the PR70 is powered off before accessing the normally guarded work area of the UniXact machine.</p>				

The PR70 and the UniXact machine have limited communication. The UniXact system monitors a ready signal input from the PR70 and sends a start signal for the shot sizes designated in the PR70's Advanced Display Module (ADM).

The machine only issues a fault if the PR70 is not ready when it calls for a dispense. The PR70 status is not considered when the home routine is completed.

1. Set up the PR70 as defined in the PR70 and Pr70v with Advanced Display Module Operation and Maintenance manual 312759.
2. Connect the two communication cables running between the PR70 and the UniXact machine.

- a. From connector 1 (near the power cord) on the PR70, to Bulkhead #1 (on the rear access panel) on the back side of the machine.
- b. From connector 2 (near the power cord) on the PR70, to Bulkhead #2 (on the rear access panel) on the back side of the machine.

NOTE: See UniXact Automated Dispense Platform Maintenance - Parts manual 3A4061 for wiring schematics.

3. Enter shot sizes 1 through 15 into the PR70 ADM. These are the only shot sizes that are available for use by the UniXact system.
4. Place the PR70 into Shot mode when using the UniXact machine as the control for metered shots.

NOTE: There will be a delay between the start dispense signal and the beginning of dispense. This is the time it takes for the pump to extend from the retracted position to the entrance of the metering tube.

NOTE: Attempting to dispense a segment bead with a volume in excess of 1 stroke results in gaps in the segment. No dispensing occurs during reload, although motion continues. There is no feedback to stop the motion during reload.

Due to the elevated force required to overcome the initial friction when the piston enters the metering tube, a consistent bead is not possible with a pneumatic drive PR70. The bead typically starts with a “snake head” blob before thinning out.

UniXact with a Servo PD44, 1053, or 1093 Dispense Valve

These servo-driven valves are completely controlled by the UniXact system and do not rely on external controls for valve operation. This valve is appropriate for dispensing consistent dots and small beads.

The most important limiting factor for consideration is the maximum dispense volume of one stroke. This valve is designed for small shots. This factor limits the length of the continuous bead that can be dispensed before the valve has to reload.

The PD44 can not dispense a volume of more than one full metered shot per part. There is no way to trigger a reload in the programming software.

UniXact with MD2, EnDure[®], or 710 Dispense Valve

These are on/off style valves with no position indicator switches. When a start dispense command is issued, the motion table initiates a single output to begin dispensing. Depending on the command, the output either remains on for a specified time or until a stop dispense command is initiated.

There are no inputs associated with this new style valve.

The UniXact system has no control of the flow rate or shot size with this style of valve. These parameters are controlled by the dispense pump system supplying material to the valve.

Appendix F: Parameters Worksheets

System Parameters

Use this worksheet to record parameter settings.

GENERAL (v = pull-down menu options)

IP Address	192.168.000.200
Save Directory	
A Button Command	v
B Button Command	v
X Button Command	v
Y Button Command	v
Number of Nests	1 or 2
Part in Fixture Sensors	Enable/Disable v
Level Sensor Installed	Enable/Disable v

PREVENTATIVE

Cycles to PM	
--------------	--

RUNNING

Smoothness	
X Rapid Rate	
Y Rapid Rate	
Z Rapid Rate	

HOMING

X Homing Rate	
Y Homing Rate	
Z Homing Rate	

JOGGING

X Jogging Rate	
Y Jogging Rate	
Z Jogging Rate	

MACHINE OFFSETS

Setup Button	Click to run app
Left Nest Zero X	
Left Nest Zero Y	
Left Nest Zero Z	
Right Nest Zero X	
Right Nest Zero Y	
Right Nest Zero Z	

MACHINE OFFSETS (Cont.)

Left Nest Pitch	
Left Nest roll	
Left Nest Skew	
Right Nest Pitch	
Right Nest Roll	
Right Nest Skew	

PART PRESENCE

Part Sensor Enable	Enable/Disable v
Left Part Present X	
Left Part Present Y	
Left Part Present Z	
Right Part Present X	
Right Part Present Y	
Right Part Present Z	

PURGING

X Purge Location	
Y Purge Location	
Z purge Location	
Purge Warn Time	
Needle Blowoff Time	
Purge Frequency	
Purge Shot Count	
Purge Dwell Time	
Process Purge Frequency	
Process Purge Shot Count	
Process Purge Dwell time	

NEEDLE FIND

Enable Needle Find	Enable/Disable v
Needlefind Tip X Offset	
Needlefind Tip Y Offset	
Needlefind Tip Z Offset	
Needlefind Sensor X Location	
Needlefind Sensor Y Location	
Needlefind Sensor Z Location	
Circle Calibration Needle Location X	
Circle Calibration Needle Location Y	
Circle Calibration Needle Location Z	

Needle Find location for calibration sensor:

X:

Y:

Z:

MAINTENANCE

Maintenance X	
Maintenance Y	
Maintenance Z	

PART LOAD

Part Load Enable	Enable/Disable v
Part Load X	
Part Load Y	
Part Load Z	
Part Load Jump Height	

SYSTEM LIMITS

X Axis Acceleration*	980
Y Axis Acceleration*	980
Z Axis Acceleration*	980
Maximum X	
Minimum X	
Maximum Y	
Minimum Y	
Maximum Z	
Minimum Z	

* Dispense axis acceleration is fixed at 4905 mm/s²

ANALOG INPUTS

Analog 1 Enable	Enable/Disable v
Analog 2 Enable	Enable/Disable v
Analog 1 at 5 volts*	
Analog 2 at 5 volts*	
Analog 1 Offset*	
Analog 2 Offset*	
Analog 1 Max Purge Alarm	
Analog 2 Max Purge Alarm	
Analog 1 Min Purge Alarm	
Analog 2 Min Purge Alarm	
Analog 1 Max Purge Warn	
Analog 2 Max Purge Warn	
Analog 1 Min Purge Warn	
Analog 2 Min Purge Warn	
Analog 1 Max Dispense Alarm*	
Analog 2 Max Dispense Alarm	
Analog 1 Min Dispense Alarm*	
Analog 2 Min Dispense Alarm	
Analog 1 Max Dispense Warn*	
Analog 2 Max Dispense Warn	
Analog 1 Min Dispense Warn*	
Analog 2 Min Dispense Warn	

* Version 6.15 uses these parameters for PCP inlet pressure monitoring.

VISION

Vision Enable	Enable/Disable v
Vision Camera IP*	
Vision Calibration Location X	
Vision Calibration Location Y	
Vision Calibration Location Z	
Circle Camera X	
Circle Camera Y	
Pixel to MM Factor	

* Default address is 192 168 000 205.

Vision parameters updated v1.0.8.0

LASER

Laser Enable	Enable/Disable v
Laser Calibration Location X	
Laser Calibration Location Y	
Laser Calibration Location Z	
Laser Calibration Height	

BARCODE

Barcode Enable	Enable/Disable v
Barcode Camera IP	192.168.0.204
Barcode Right Position X	
Barcode Right Position Y	
Barcode Right Position Z	
Barcode Left Position X	
Barcode Left Position Y	
Barcode Left Position Z	

Valve Parameters**1053**

Purge Amount	
Purge Rate	
Purge Final Rate	
Purge Change Rate Pos	
Process Purge Amount	
Process Purge Rate	
Process Purge Final Rate	
Process Change Rate Pos	
With Snuff Back	Enable/Disable v
Snuff Back Volume	
Snuff Back Rate	
Shot Amount	
Shot Rate	
Dispenser Reload Rate	
Dispense Homing Rate	
Dispense Jogging Rate	
Stoke Length	
Pitch	
Diameter	
Max Rate	
Volume/Rev	

1093

Purge Amount	
Purge Rate	
Purge Final Rate	
Purge Change Rate Pos	
Process Purge Amount	
Process Purge Rate	
Process Purge Final Rate	
Process Change Rate Pos	
With Snuff Back	Enable/Disable v
Snuff Back Volume	
Snuff Back Rate	
Shot Amount	

1093 (Cont.)

Shot Rate	
Dispenser Reload Rate	
Dispense Homing Rate	
Dispense Jogging Rate	
Stoke Length	
Pitch	
Diameter	
Max Rate	
Volume/Rev	

710

Purge Time	
Process Purge Time	
Test Shot Time	

Endure

Purge Time	
Process Purge Time	
Test Shot Time	

MD2

Purge Time	
Process Purge Time	
Test Shot Time	

PD44

Purge Amount	
Purge Rate	
Purge Final Rate	
Purge Change Rate Pos	
Process Purge Amount	
Process Purge Rate	
Process Purge Final Rate	
Process Change Rate Pos	
Shot Amount	
Shot Rate	
Dispenser Reload Rate	
Dispense Homing Rate	
Dispense Jogging Rate	
Stoke Length	
Pitch	
Diameter (Lo)	
Diameter (Hi)	
Max Rate	
Volume/Rev	

PR70

Purge Shot	Select Shot # v
Test Shot	Select Shot # v
PR70 Mode	Shot/Operator v
Operator Mode Purge Time	
Operator Mode Test Shot Time	
Shot 1 Amount	
Shot 2 Amount	
Shot 3 Amount	
Shot 4 Amount	
Shot 5 Amount	
Shot 6 Amount	
Shot 7 Amount	
Shot 8 Amount	
Shot 9 Amount	
Shot 10 Amount	
Shot 11 Amount	
Shot 12 Amount	

PCP (Progressive Cavity Pump)

Gear Box Ratio	
Max Rate	
Volume/Rev	
With Snuff Back	Enable/Disable v
Snuff Back Volume	
Snuff Back Rate	
Shot Size Amount	
Shot Rate	
Jog Rate	
Purge Rate	
Purge Amount	
Enable Depressurization	Enable/Disable v
Depressurization Pressure	

PCF

Purge Time	
Process Purge Time	
Test Shot Time	

Alternate Purge Parameters

(Software Version 5.10)

Purge Parameters

for: _____

X Purge Location	
Y Purge Location	
Z purge Location	
Purge Warn Time	
Needle Blowoff Time	
Purge Frequency	
Purge Shot Count	
Purge Dwell Time	
<i>Purge Amount</i>	
<i>Purge Rate</i>	
<i>Purge Change Rate Position</i>	
<i>Purge Final Rate</i>	
Process Purge Frequency	
Process Purge Shot Count	
Process Purge Dwell time	
<i>Process Purge Amount</i>	
<i>Process Purge Rate</i>	
<i>Process Change Rate Pos</i>	
<i>Process Purge Final Rate</i>	

NOTE: Parameters that are shown indented and in italics are located in the valve parameters tab

Appendix G: Support File Utility

The Unixact software can save a copy of all system parameter files including log files, database files, and program files that are saved in the location defined on the Parameters screen. The support file utility will automatically place these files in a zip file that is stored on C:\Graco\Support.

1. Select the software version in the lower right corner of any screen.



2. Press Save to save in the default file location.

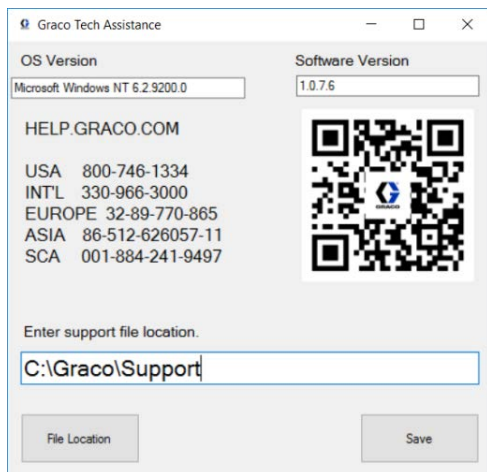

The .zip file that is created when you select Save contains the following:

- Copy of all the configuration files (*.cfg9) from C:\Graco.
- Copy of the db.s3db (database file) from C:\Graco.
- Copy of the Log Folder from C:\Graco.
- Copy of all part program files (*.xml) located in the Save Directory defined on the Parameters screen.
- Copy of the Graco.txt file.
- Copy of the IODef.txt file.
- MachineInfo.dat file that contains run screen settings and SPC screen data.

The file name is created with the current date.

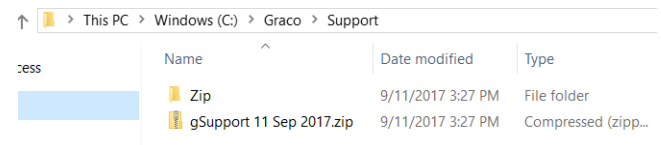

NOTE: Using the support utility multiple times in one day with the same file location overwrites the previous dated file each time.

Dimensions

C-300

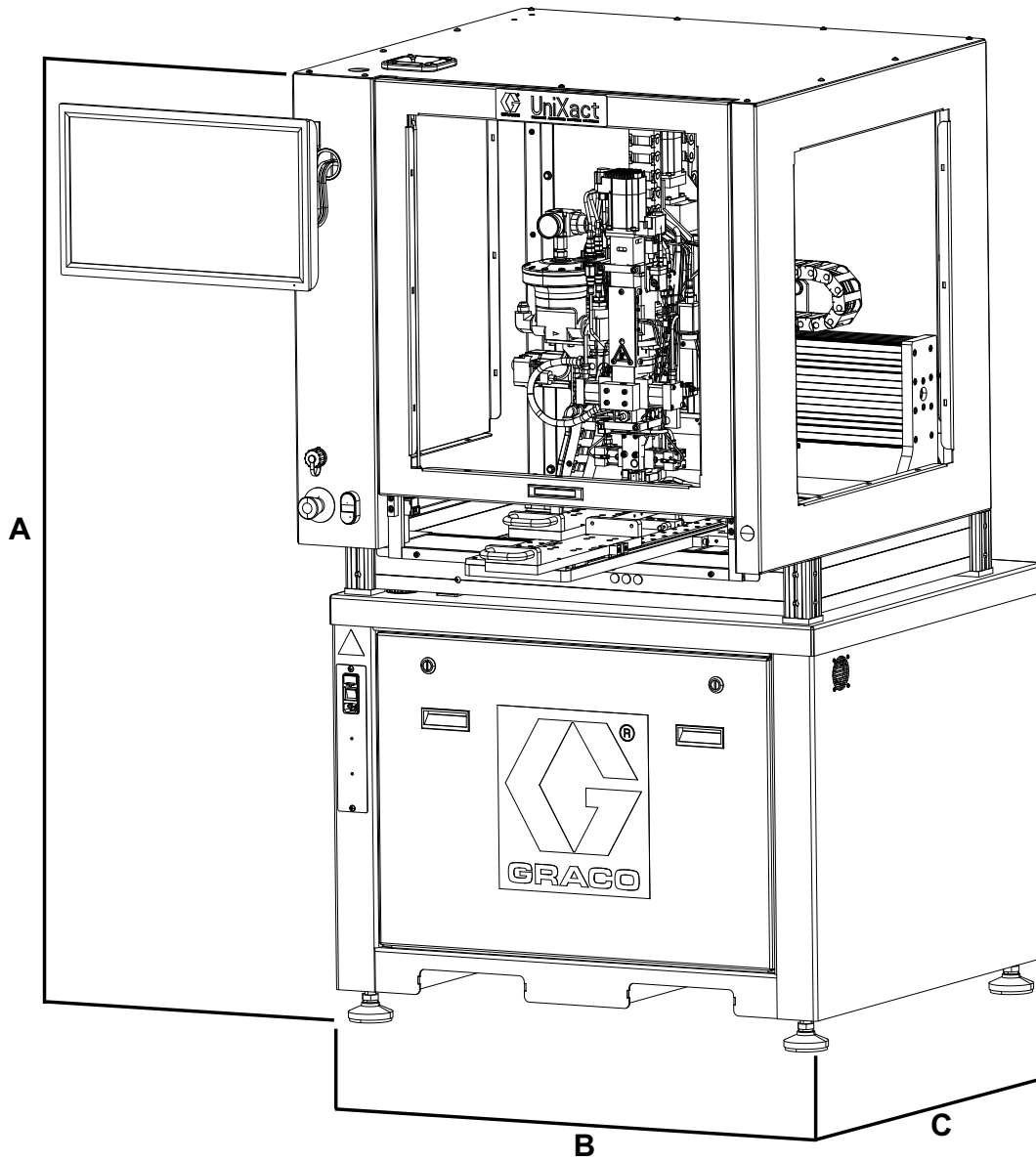

FIG. 19: C-300 Dimensions

Dimensions	US (in.)	Metric (cm)
A (Height)	65.5	166.4
(Height Door Up)	85.6	217.4
B (Base Width)	37	94
C (Base Depth)	37	94

C-500

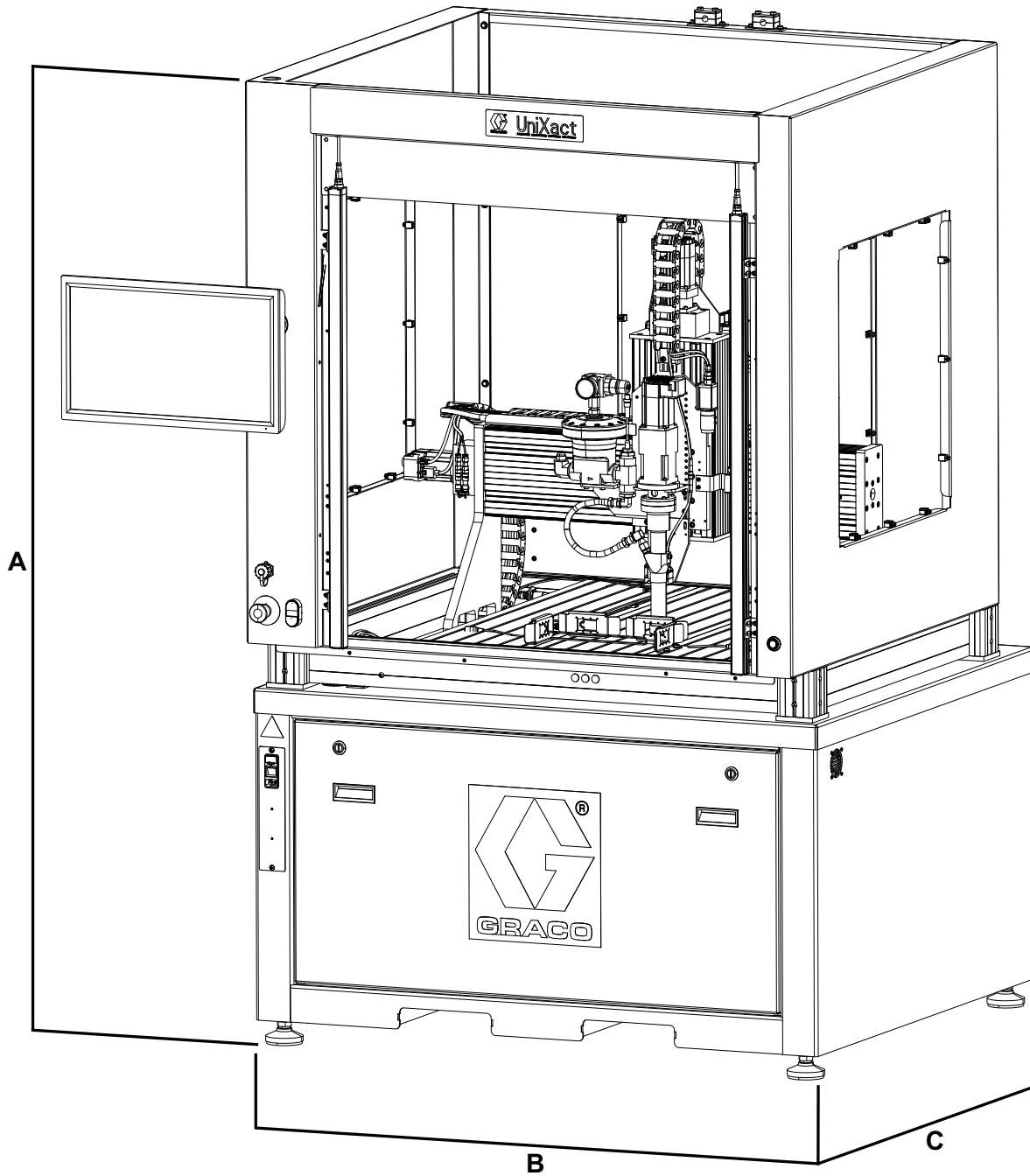

FIG. 20: C-500 Dimensions

Dimensions	US (in.)	Metric (cm)
A (Height)	78	198
B (Base Width)	48	122
C (Base Depth)	51	129.5

Dispense Platform Mounting Dimensions

For use when mounting your own fixture for holding parts to the UniXact dispense platform. Utilize the T-slots for attaching your fixture. T-slot nuts are available from Graco, part no. 17K042 (M6).

Figure 21 shows a cutaway section of the front view of the C-500 dispense platform with dimensions. The C-500 has (15) T-slots and the C-300 has (9) T-slots.

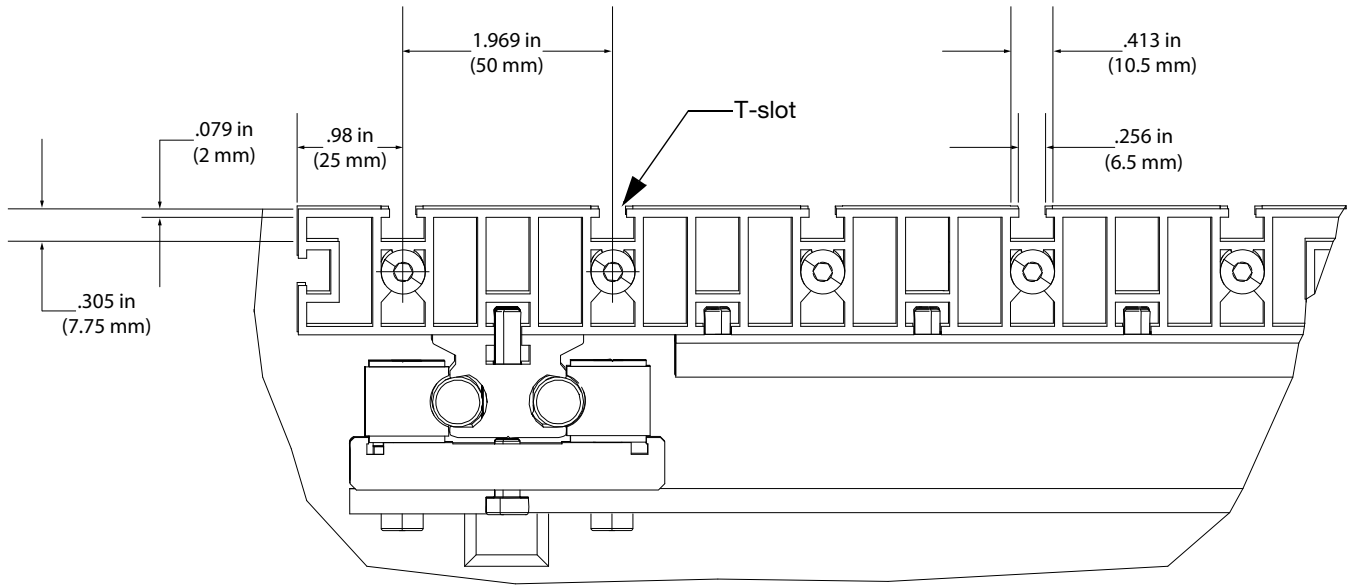

FIG. 21: C-300/C-500 Dispense Platform Dimensions

Technical Specifications

C-300 and C-500		
	US	Metric
Air pressure operating range*	80-100 psi	0.6-0.7 MPa, 5.5-7 bar
Maximum air consumption**	0-2 scfm	0.3 m ³ /minute
Power requirements	100-240 VAC, 4 AMP, 50/60 Hz	
Load carrying capacity	33 lb	15 kg
Inlet/Outlet Sizes		
Air inlet size	1/4 in. npt(f)	
Air exhaust port size	n/a	
Wetted materials on all models	Refer to the manual for the dispenser. See Related Manuals.	
Weight		
C-300	570 lb	258.5 kg
C-500	850 lb	385.6 kg
Notes		
*Startup pressures and displacement per cycle may vary based on suction condition, discharge head, air pressure, and fluid type.		
** Depending on options.		

California Proposition 65

CALIFORNIA RESIDENTS

 **WARNING:** Cancer and reproductive harm – www.P65warnings.ca.gov.

Graco Standard Warranty

Graco warrants all equipment referenced in this document which is manufactured by Graco and bearing its name to be free from defects in material and workmanship on the date of sale to the original purchaser for use. With the exception of any special, extended, or limited warranty published by Graco, Graco will, for a period of twelve months from the date of sale, repair or replace any part of the equipment determined by Graco to be defective. This warranty applies only when the equipment is installed, operated and maintained in accordance with Graco's written recommendations.

This warranty does not cover, and Graco shall not be liable for general wear and tear, or any malfunction, damage or wear caused by faulty installation, misapplication, abrasion, corrosion, inadequate or improper maintenance, negligence, accident, tampering, or substitution of non-Graco component parts. Nor shall Graco be liable for malfunction, damage or wear caused by the incompatibility of Graco equipment with structures, accessories, equipment or materials not supplied by Graco, or the improper design, manufacture, installation, operation or maintenance of structures, accessories, equipment or materials not supplied by Graco.

This warranty is conditioned upon the prepaid return of the equipment claimed to be defective to an authorized Graco distributor for verification of the claimed defect. If the claimed defect is verified, Graco will repair or replace free of charge any defective parts. The equipment will be returned to the original purchaser transportation prepaid. If inspection of the equipment does not disclose any defect in material or workmanship, repairs will be made at a reasonable charge, which charges may include the costs of parts, labor, and transportation.

THIS WARRANTY IS EXCLUSIVE, AND IS IN LIEU OF ANY OTHER WARRANTIES, EXPRESS OR IMPLIED, INCLUDING BUT NOT LIMITED TO WARRANTY OF MERCHANTABILITY OR WARRANTY OF FITNESS FOR A PARTICULAR PURPOSE.

Graco's sole obligation and buyer's sole remedy for any breach of warranty shall be as set forth above. The buyer agrees that no other remedy (including, but not limited to, incidental or consequential damages for lost profits, lost sales, injury to person or property, or any other incidental or consequential loss) shall be available. Any action for breach of warranty must be brought within two (2) years of the date of sale.

GRACO MAKES NO WARRANTY, AND DISCLAIMS ALL IMPLIED WARRANTIES OF MERCHANTABILITY AND FITNESS FOR A PARTICULAR PURPOSE, IN CONNECTION WITH ACCESSORIES, EQUIPMENT, MATERIALS OR COMPONENTS SOLD BUT NOT MANUFACTURED BY GRACO. These items sold, but not manufactured by Graco (such as electric motors, switches, hose, etc.), are subject to the warranty, if any, of their manufacturer. Graco will provide purchaser with reasonable assistance in making any claim for breach of these warranties.

In no event will Graco be liable for indirect, incidental, special or consequential damages resulting from Graco supplying equipment hereunder, or the furnishing, performance, or use of any products or other goods sold hereto, whether due to a breach of contract, breach of warranty, the negligence of Graco, or otherwise.

FOR GRACO CANADA CUSTOMERS

The Parties acknowledge that they have required that the present document, as well as all documents, notices and legal proceedings entered into, given or instituted pursuant hereto or relating directly or indirectly hereto, be drawn up in English. Les parties reconnaissent avoir convenu que la rédaction du présente document sera en Anglais, ainsi que tous documents, avis et procédures judiciaires exécutés, donnés ou intentés, à la suite de ou en rapport, directement ou indirectement, avec les procédures concernées.

Graco Information

For the latest information about Graco products, visit www.graco.com.

For patent information, see www.graco.com/patents.

TO PLACE AN ORDER, contact your Graco distributor or call to identify the nearest distributor.

Phone: 612-623-6921 or Toll Free: 1-800-746-1334 Fax: 330-966-3006

All written and visual data contained in this document reflects the latest product information available at the time of publication. Graco reserves the right to make changes at any time without notice.

Original instructions. This manual contains English. MM 3A3649

Graco Headquarters: Minneapolis

International Offices: Belgium, China, Japan, Korea

GRACO INC. AND SUBSIDIARIES • P.O. BOX 1441 • MINNEAPOLIS MN 55440-1441 • USA
Copyright 2017, Graco Inc. All Graco manufacturing locations are registered to ISO 9001.

www.graco.com

Revision D, January 2022