

Grease Jockey Lubrication Controller

334662E
EN

For controlling and monitoring an automated lubrication system.

Not approved for outdoor use or use in explosive atmospheres or hazardous locations.

Model: 24W482



Important Safety Instructions
Read all warnings and instructions in
this manual. Save these instructions.

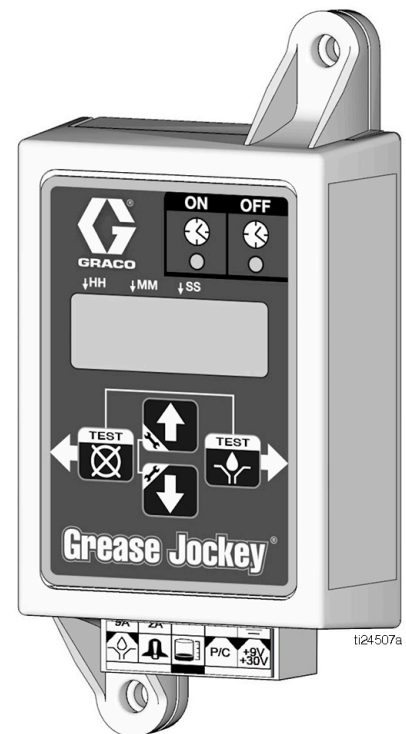

Warnings

The following warnings are for the setup, use, grounding, maintenance, and repair of this equipment. The exclamation point symbol alerts you to a general warning and the hazard symbols refer to procedure-specific risks. When these symbols appear in the body of this manual or on warning labels, refer back to these Warnings. Product-specific hazard symbols and warnings not covered in this section may appear throughout the body of this manual where applicable.

WARNING



EQUIPMENT MISUSE HAZARD

Misuse can cause death or serious injury.

- Do not operate the unit when fatigued or under the influence of drugs or alcohol.
- Do not exceed the maximum working pressure or temperature rating of the lowest rated system component. See **Technical Data** in all equipment manuals.
- Use fluids and solvents that are compatible with equipment wetted parts. See Technical Data in all equipment manuals. Read fluid and solvent manufacturer's warnings. For complete information about your material, request MSDS from distributor or retailer.
- Turn off all equipment and follow the **Pressure Relief Procedure** when equipment is not in use.
- Check equipment daily. Repair or replace worn or damaged parts immediately with genuine manufacturer's replacement parts only.
- Do not alter or modify equipment. Alterations or modifications may void agency approvals and create safety hazards.
- Make sure all equipment is rated and approved for the environment in which you are using it.
- Use equipment only for its intended purpose. Call your distributor for information.
- Route hoses and cables away from traffic areas, sharp edges, moving parts, and hot surfaces.
- Do not kink or over bend hoses or use hoses to pull equipment.
- Keep children and animals away from work area.
- Comply with all applicable safety regulations.



Component Identification

Keypad, Display, and Icons

NOTICE

To prevent damage to soft key buttons, do not press the buttons with sharp objects such as pens, plastic cards, or fingernails.

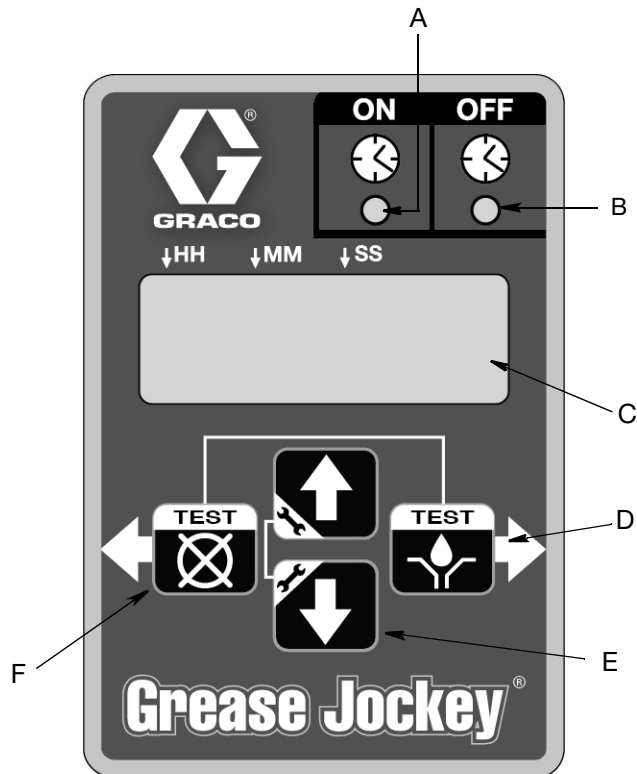

ti24508a

FIG. 1

RIGHT Direction Arrow / TEST / ENTER (D)

- In SETUP MODE, saves entry, moves cursor in display one field to the right or to the next setup step.
- In RUN MODE activates the pump for one complete ON cycle if actuated during the OFF portion of the RUN cycle.

UP and DOWN Direction Arrows (E)

- Press and hold both the UP and DOWN Arrow keys together for 3 seconds to enter SETUP MODE.
- In SETUP MODE increase or decrease number values associated with operation.

LEFT Direction Arrow / TEST / RESET (F)

- In SETUP MODE moves cursor in display one field to the left.
- In RUN MODE, Pressing RESET starts a PUMP OFF cycle.
- Press and hold left and right direction arrow together for 3 seconds to enter TEST MODE.

Pump ON LEDs (A)

- Time Control LED: In RUN MODE illuminates indicating function mode that is currently running.

Pump OFF LED (B)

- In RUN MODE this LED illuminates when in the OFF or RESET portion of the RUN CYCLE.

Display (C)

- A blinking field on the display indicates the controller is in SETUP MODE.
- In RUN MODE numbers on the display will not blink.

Installation

The installation shown in FIG. 2 is only a guide for selecting and installing system components. Contact your Graco distributor for assistance in planning a system to suit your needs.

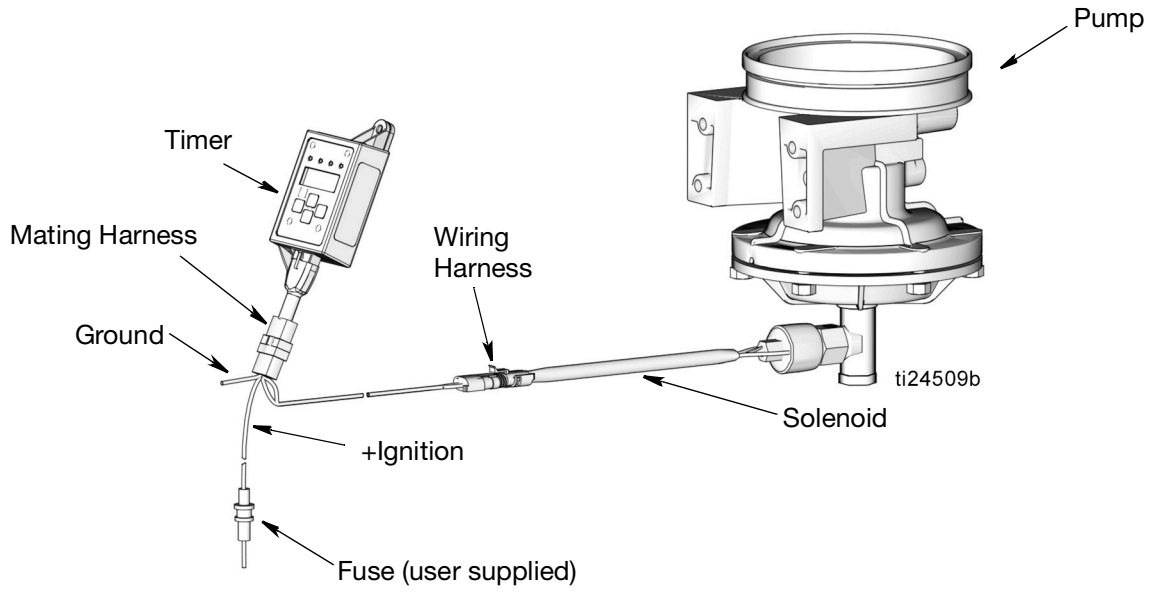
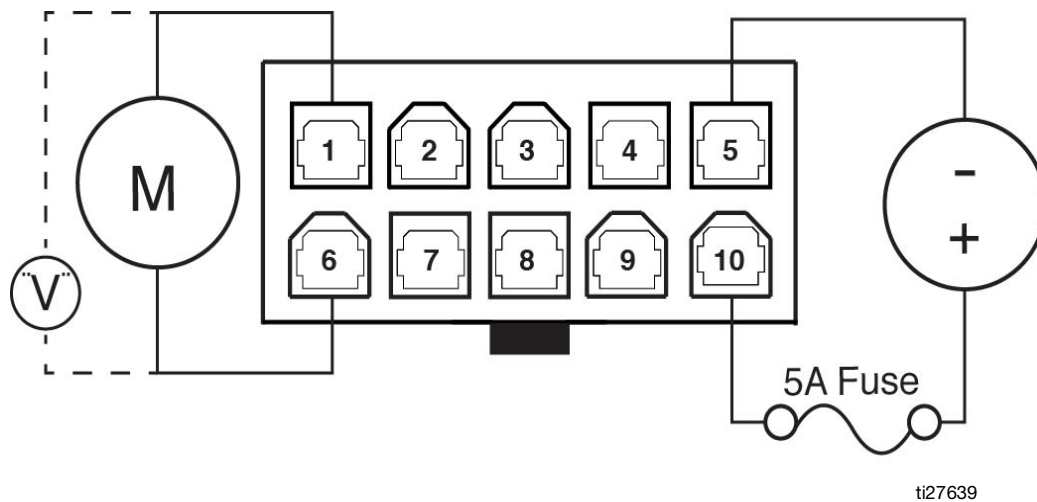

FIG. 2

Wiring Diagram

Modes of Operation: Optional I/O Wiring Diagram



ti27639

FIG. 3

Wiring Key

Pin	Description	+/-
1	Pump	-
2	Not Used	NA
3	Not Used	NA
4	Not Used	NA
5	Voltage Input	-
6	Pump	+
7	Not Used	NA
8	Not Used	NA
9	Not Used	NA
10	Voltage Input	+

Connector Identification Label

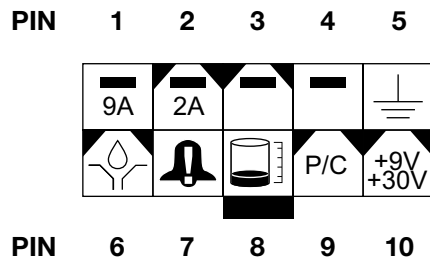

System Wiring

AUTOMATIC SYSTEM ACTIVATION HAZARD						
Unexpected activation of the system could result in serious injury, including skin injection and amputation.						
This device has an automatic timer that activates the pump lubrication system when power is connected or when exiting the programming function. Before you install or remove the Lubrication Controller from the system, disconnect and isolate all power supplies and relieve all pressure.						

Timer Installation

1. Connect timer leads to solenoid. A wiring harness kit with a mating connector is available from your Graco distributor.

Mating Harnesses

- 127899 - 8 inch harness with DELPHI 56 connector
- 127900 - 8 inch harness with DELPHI 280 connector
- 24P314 - 5 foot harness with flying leads

NOTE: All connections between timer and solenoid must be moisture-proof and safe from grounding.

NOTICE

Do not ground the pump wires to the solenoid. This could cause damage to the timer.

2. Connect the voltage input (+) wire to the positive side of the vehicle ignition switch. Install a 5 amp fuse at this connection.
3. Connect the voltage input (-) wire to the chassis ground.

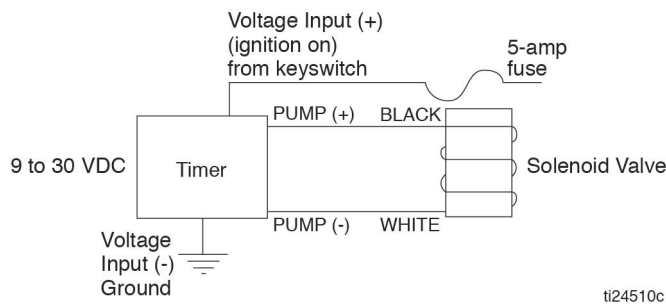

FIG. 4

Installing the Lubrication Controller

1. Install the Lubrication Controller to a flat surface.
2. Drill mounting holes. Refer to the Mounting Hole Layout Provided in the Technical Data section, page 15. A Grease Jockey timer retrofit kit is available from your Graco distributor. See Related Kits, page 13.
3. Align junction box with predrilled holes (FIG. 5, (a)). Use two screws (not provided) to secure junction box to mounting surface.

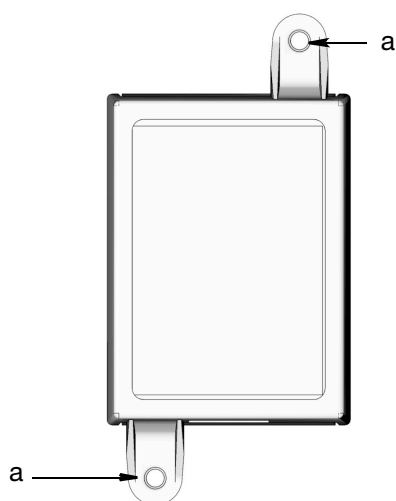

FIG. 5









Setting Up a Personal Identification Number (PIN) (Optional)

Setup Code A1 is available to secure the setup modes with a PIN. A required PIN provides the system with added security by preventing unauthorized users from making adjustments to the settings. A PIN is not required.

Entering a PIN Code for the First Time

A1-Setting Up PIN Code

A PIN Code can be programmed into the Grease Jockey Controller to protect the settings from inadvertently being changed by unauthorized users.



1. Press the UP ARROW button for 3 seconds. 
2. Press the ENTER button to select the A1 option. 
3. Press the UP or DOWN ARROW button to change this to ON.  
4. Press the ENTER button to enter the PIN Code. 
5. Use the UP and DOWN ARROW buttons to move up and down through the numbers 0-9 until the first number in the PIN code is displayed in the field.  
6. Press the ENTER button to set the number. The cursor automatically moves to the next number field. 
7. Repeat steps 5 and 6 for each PIN Code prompt field.
8. Press the ENTER button to save the PIN Code and exit Advanced Setup. 

Entering Advanced Setup

Press the UP ARROW button for 3 seconds.



If the Grease Jockey Controller was previously set up to require a PIN Code:



1. Use the UP and DOWN ARROW buttons to move up and down through the numbers 0-9 until the first number in the PIN code is displayed in the field.  
2. Press the ENTER button to set the number. The cursor automatically moves to the next number field. 
3. Repeat steps 1 and 2 for each PIN Code prompt field.

Setup

Entering SETUP MODE

Press both the UP and DOWN ARROW buttons together for three seconds.

If the Grease Jockey Controller was previously set up to require a PIN Code:

- Use the UP and DOWN ARROW buttons to move up and down through the numbers 0-9 until the first number in the PIN code is displayed in the field.
 

- Press the ENTER button to set the number. The cursor automatically moves to the next number field.
 
- Repeat steps 1 and 2 for each PIN Code prompt field.

NOTE:

- If a button is not pushed for 1 minute, the controller resumes operation.
- Setting changes are not stored unless programming is completed and setup mode is exited normally by pressing the ENTER button.
- A blinking dot below the HH, MM, or SS indicates the field currently being programmed.

Programming ON Duration

- on:ti** appears on the display identifying the function you are programming (see below).

on:ti |

- The illuminated LED below the related symbol on the controller label also indicates the function.

- on:ti** = Time Control, a specific duration of time elapses

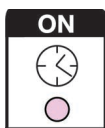

on:ti |

Time Control (on:ti) ON Setup

- on:ti** is on the display.

on:ti |

- Press ENTER.



- To set the ON time use the UP or DOWN ARROW to scroll through the numerals 0-5 until the desired number appears in the first Minutes (MM) field.

NOTE:

- The MM field is a 2-digit number.
- A leading zero (0) must be entered in the first field if the number of minutes is fewer than 10.
- The highest number that can be set for the MM field value is 59.

- Press the ENTER button.

The next MM number field to the right flashes, indicating it is ready for programming.

- Use the UP or DOWN ARROW to scroll through the numerals 0-9 until the desired number appears in the second MM number field.
- Press the ENTER button.

The next number field to the right flashes indicating it is ready to program the Seconds (SS) fields.

NOTE:

- The Seconds (SS) field is a 2-digit number.
- A leading zero (0) must be entered in the first field if the number of seconds is fewer than 10.
- The highest number that can be set for the SS field value is 59.

- Repeat steps 3 - 6 to set the SS fields.

- Press the ENTER button. After you press the ENTER button the controller automatically switches to the OFF TIME SETUP MODE.

Programming OFF TIME Duration

After setting the parameters for the Time (Ti) ON Mode, the OFF TIME or PUMP REST CYCLE must be set up.

The LED below the OFF TIME Symbol Illuminates.

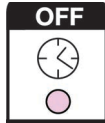

NOTE:

- The HH field is a 2-digit number.
- A leading zero (0) must be entered in the first field if the number of hours is fewer than 10.
- The highest number that can be set for the HH field value is 99.

To set the OFF Time:

1. Use the UP or DOWN ARROW to scroll through the numerals 0-9 until the desired number appears in the first Hours (HH) field.



2. Press ENTER.



The next HH number field to the right flashes, indicating it is ready for programming.

3. Use the UP or DOWN ARROW to scroll through the numerals 0-9 until the desired number appears in the second HH field.



4. Press the ENTER button.



The next number field to the right flashes indicating it is ready to program the Minutes (MM) fields.

NOTE:

- The MM field is a 2-digit number.
- A leading zero (0) must be entered in the first field if the number of minutes is fewer than 10.

- The highest number that can be set for the MM field value is 59.

5. Repeat steps 1 - 4 to set the MM fields.

6. Press the ENTER button to lock in the last MM field.



NOTE: When the user exits SETUP MODE:

- The display shows the firmware version.
- The controller goes to the beginning of a PUMP OFF Cycle.

Operation

Run Mode

The controller is in Run Mode providing the following circumstances are present:

- The controller is not in SETUP MODE.
- An Alarm is not active.

Timer Mode: Pump ON

The display indicates the amount of time remaining in the pump cycle, counting down the Pump ON time value (see Time Control (on:ti) ON Setup, page 9).

- The Pump output is enabled.
- Pump ON time is shown in MM:SS (minutes:seconds).

Timer Mode: Pump OFF

The display indicates the amount of time remaining in the pump OFF cycle, counting down the Pump OFF time value (see Programming OFF Time Duration, page 10).

- The Time OFF LED illuminates and the pump output is disabled during the Pump OFF time.
- Pump OFF time is shown in HH:MM (hours:minutes) or MM:SS if the time remaining is less than an hour.

Test Mode

To enter Test Mode:

1. Press the LEFT and RIGHT ARROW buttons together for 3 seconds.



2. The unit will cycle ON for 45 seconds and OFF for 15 seconds until the Test Mode is exited.

3. To exit Test Mode, press the Reset button once.



Troubleshooting

Description	Problem	Solution
Unit does not power on or display is dim/unresponsive	Incorrect or loose wiring	Refer to installation instructions beginning on page 4.
	Input voltage is out of range	Confirm power source is between 9 and 30 VDC.
	Tripped external fuse	Confirm that none of the devices or wiring connected to the controller are causing a short circuit connection. Replace fuse. If fuse trips again, contact Graco Customer Support.
Pump is not running during Pump ON	Incorrect or loose wiring	Confirm current is being delivered to the pump during pump ON. Refer to installation instructions, page 4. Verify that your machine has been wired correctly.
	Controller output is incorrect	Confirm output voltage (PUMP+) from controller during pump ON is correct (should be similar to input voltage). NOTE: Measure at controller to ensure there is not wiring issue causing the problem. If controller output voltage is never present, the device may need replacement.
	Air solenoid failure	Replace air solenoid.
Reservoir quickly and unexpectedly runs out of grease	Test mode is engaged	Turn off test mode.

Program Settings

Description	Modes of Operation Maximum / Minimum
TIME ON, page 9	MM:SS (00:01 - 59:59)
TIME OFF, page 10	HH:MM (00:01 - 99:59)

Recommended Timer Settings

NOTE: These are recommended settings only. Experience with individual applications will determine timer setting.

Timer Setting	Driving Conditions
1/2 or 1 hr	Off Highway
1.5 or 2 hr	Start and stop city, heavy salt, snow and ice, rough pavement, wet climate, heavy loads, dusty roads.
3 hr	Normal city or highway driving, normal climate, moderate loads.

Parts

Ref.	Description	Qty
1	BOX, enclosure	1
2	LABEL, control, overlay	1
3	LABEL, serial, name	1
4	LABEL, connector	1

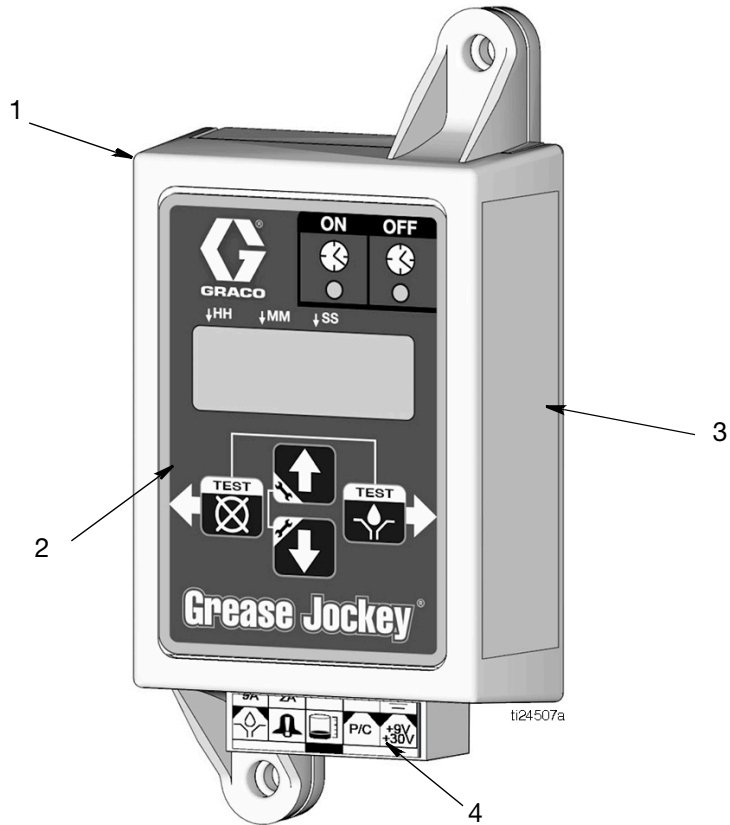

Accessories

Related Kits

Kit No.	Description
127900	HARNESS, Grease Jockey, Delphi 280
127899	HARNESS, Grease Jockey, Delphi 56
24P314	CABLE, wiring harness
24X606	KIT, Grease Jockey Grease timer retrofit

Technical Specifications

Input Contact	
Power Source DC	9 - 30 VDC
Power Consumption	1 Watt
Outputs	
Pump control	Pump Control Voltage = Power Source
Voltage	Pump Control Voltage = Power Source
Max Switching Voltage	30 VDC
Max Switching Current	7A (DC), 9A (Peak)
Min Switching Current	100 mA (DC)
Protection grade	IP54 for indoors and vehicle cab use
Enclosure Material	ABS
Membrane Material	Polyester
Maximum Humidity	90% RH (non-condensing)
Operating temperature range	- 40°F to 176°F (- 40°C to 80°C)
Storage Temperature	- 40°F to 176°F (- 40°C to 80°C)

Dimensions

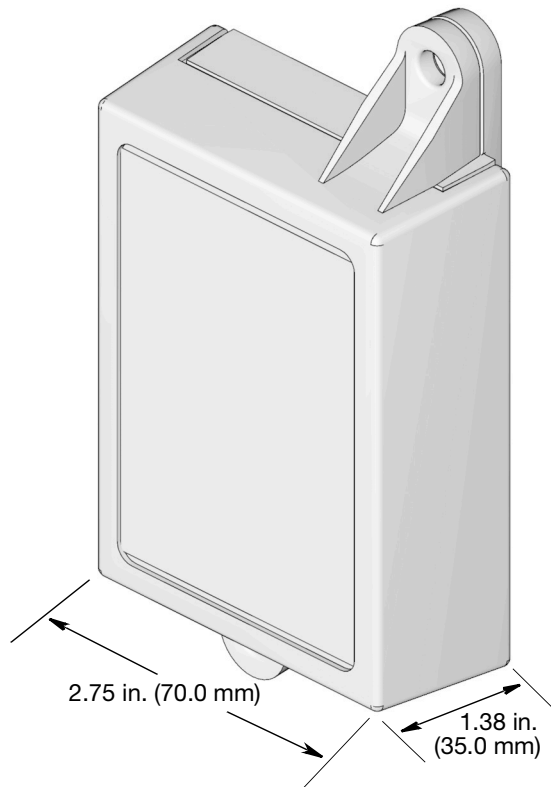

Mounting Hole Layout

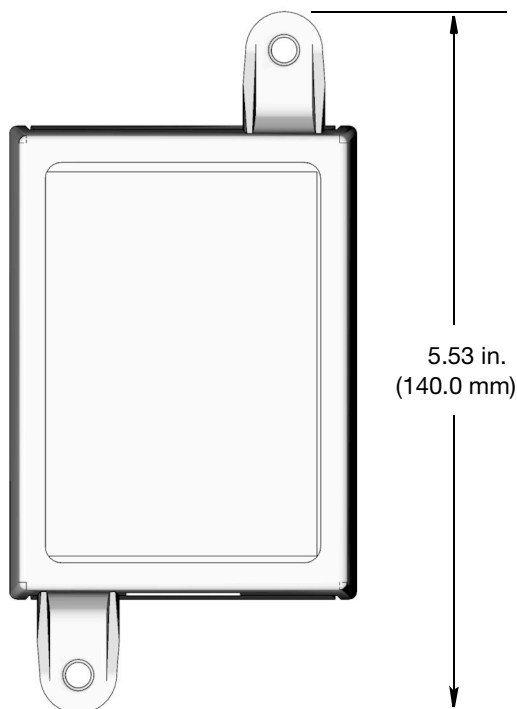
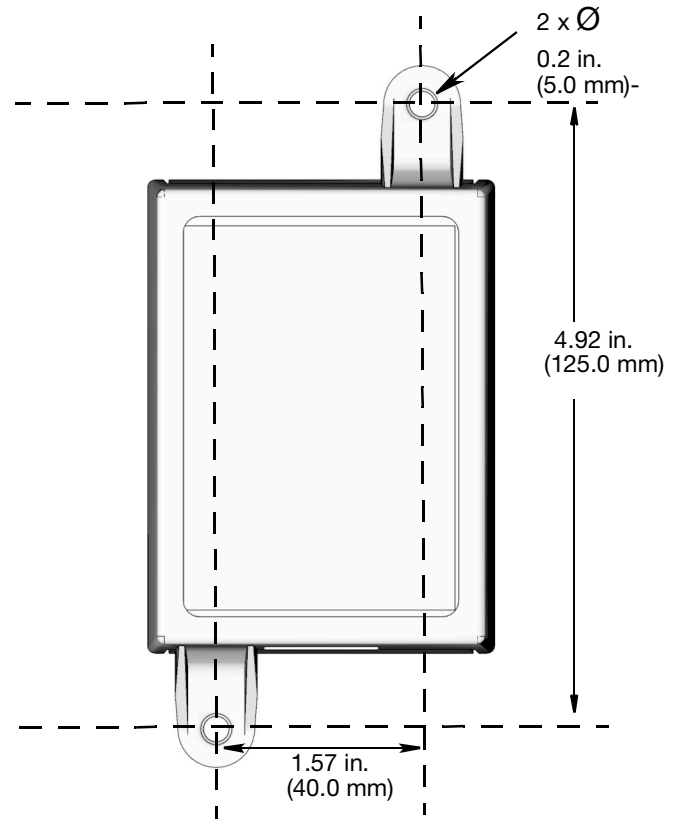

Graco Standard Warranty

Graco warrants all equipment referenced in this document which is manufactured by Graco and bearing its name to be free from defects in material and workmanship on the date of sale to the original purchaser for use. With the exception of any special, extended, or limited warranty published by Graco, Graco will, for a period of twelve months from the date of sale, repair or replace any part of the equipment determined by Graco to be defective. This warranty applies only when the equipment is installed, operated and maintained in accordance with Graco's written recommendations.

This warranty does not cover, and Graco shall not be liable for general wear and tear, or any malfunction, damage or wear caused by faulty installation, misapplication, abrasion, corrosion, inadequate or improper maintenance, negligence, accident, tampering, or substitution of non-Graco component parts. Nor shall Graco be liable for malfunction, damage or wear caused by the incompatibility of Graco equipment with structures, accessories, equipment or materials not supplied by Graco, or the improper design, manufacture, installation, operation or maintenance of structures, accessories, equipment or materials not supplied by Graco.

This warranty is conditioned upon the prepaid return of the equipment claimed to be defective to an authorized Graco distributor for verification of the claimed defect. If the claimed defect is verified, Graco will repair or replace free of charge any defective parts. The equipment will be returned to the original purchaser transportation prepaid. If inspection of the equipment does not disclose any defect in material or workmanship, repairs will be made at a reasonable charge, which charges may include the costs of parts, labor, and transportation.

THIS WARRANTY IS EXCLUSIVE, AND IS IN LIEU OF ANY OTHER WARRANTIES, EXPRESS OR IMPLIED, INCLUDING BUT NOT LIMITED TO WARRANTY OF MERCHANTABILITY OR WARRANTY OF FITNESS FOR A PARTICULAR PURPOSE.

Graco's sole obligation and buyer's sole remedy for any breach of warranty shall be as set forth above. The buyer agrees that no other remedy (including, but not limited to, incidental or consequential damages for lost profits, lost sales, injury to person or property, or any other incidental or consequential loss) shall be available. Any action for breach of warranty must be brought within two (2) years of the date of sale.

GRACO MAKES NO WARRANTY, AND DISCLAIMS ALL IMPLIED WARRANTIES OF MERCHANTABILITY AND FITNESS FOR A PARTICULAR PURPOSE, IN CONNECTION WITH ACCESSORIES, EQUIPMENT, MATERIALS OR COMPONENTS SOLD BUT NOT MANUFACTURED BY GRACO. These items sold, but not manufactured by Graco (such as electric motors, switches, hose, etc.), are subject to the warranty, if any, of their manufacturer. Graco will provide purchaser with reasonable assistance in making any claim for breach of these warranties.

In no event will Graco be liable for indirect, incidental, special or consequential damages resulting from Graco supplying equipment hereunder, or the furnishing, performance, or use of any products or other goods sold hereto, whether due to a breach of contract, breach of warranty, the negligence of Graco, or otherwise.

FOR GRACO CANADA CUSTOMERS

The Parties acknowledge that they have required that the present document, as well as all documents, notices and legal proceedings entered into, given or instituted pursuant hereto or relating directly or indirectly hereto, be drawn up in English. Les parties reconnaissent avoir convenu que la rédaction du présente document sera en Anglais, ainsi que tous documents, avis et procédures judiciaires exécutés, donnés ou intentés, à la suite de ou en rapport, directement ou indirectement, avec les procédures concernées.

Graco Information

For the latest information about Graco products, visit www.graco.com.

For patent information, see www.graco.com/patents.

TO PLACE AN ORDER, contact your Graco distributor or call to identify the nearest distributor.

Phone: 612-623-6928 **or Toll Free:** 1-800-533-9655, **Fax:** 612-378-3590

*All written and visual data contained in this document reflects the latest product information available at the time of publication.
Graco reserves the right to make changes at any time without notice.*

This manual contains English. MM 334662

Graco Headquarters: Minneapolis

International Offices: Belgium, China, Japan, Korea

GRACO INC. AND SUBSIDIARIES • P.O. BOX 1441 • MINNEAPOLIS MN 55440-1441 • USA

Copyright 2014, Graco Inc. All Graco manufacturing locations are registered to ISO 9001.

www.graco.com

August, 2021