

# Air-Driven Agitators

306840S

EN

***Air-driven agitators for mixing and maintaining suspension of industrial coatings.  
For professional use only.***

100 psi (0.7 MPa, 7 bar) Maximum Working Pressure

See page 2 for model information.



## Important Safety Instructions

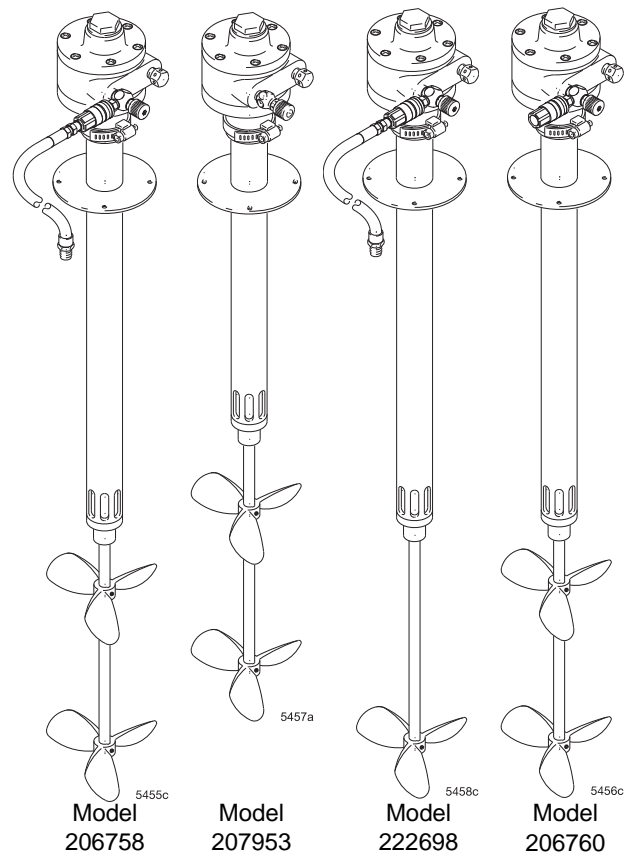

Read all warnings and instructions in this manual before using the equipment.  
Save these instructions.



# Contents









<b>Models</b> .....	<b>2</b>	<b>Service</b> .....	<b>10</b>
<b>Warnings</b> .....	<b>3</b>	<b>Parts</b> .....	<b>11</b>
<b>Installation</b> .....	<b>5</b>	Model 206758 .....	11
Air Requirements .....	5	Model 206760 .....	12
Air Line Accessories .....	5	Model 207953 .....	13
Install Air Line Accessories .....	6	Model 222698 .....	14
Install the Agitator on the Drum .....	6	<b>Performance Charts</b> .....	<b>15</b>
Grounding .....	7	<b>Dimensions</b> .....	<b>15</b>
<b>Operation</b> .....	<b>8</b>	<b>Mounting Hole Layout</b> .....	<b>16</b>
Find the Proper Agitator Speed .....	8	<b>Technical Specifications</b> .....	<b>17</b>
Pressure Relief Procedure .....	8	<b>California Proposition 65</b> .....	<b>17</b>
Operate the Agitator .....	8	<b>Graco Standard Warranty</b> .....	<b>18</b>
<b>Maintenance</b> .....	<b>9</b>		
Flush the Air Motor .....	9		
Agitator Blades .....	9		
Lubricate the Air Motor .....	9		
Clean the Shaft .....	9		

# Models





Model	Description	HP Motor Size	Agency Approvals
206758	Carbon Steel Agitator for 30-gallon mix tanks and 55-gallon drums	3/4	   <b>II 1/2 G Ex h IIB T4 Ga/Gb</b> <b>ITS03ATEX11226X</b> <b>ITS21UKEX0224X</b>
206760	Carbon Steel Agitator for 60-gallon mix tanks	1 1/2	
207953	Carbon Steel Agitator for 15-gallon mix tanks	3/4	
222698	Stainless Steel Agitator for 30-gallon mix tanks and 55-gallon drums	3/4	

# Warnings



The following warnings are for the setup, use, grounding, maintenance, and repair of this equipment. The exclamation point symbol alerts you to a general warning and the hazard symbols refer to procedure-specific risks. When these symbols appear in the body of this manual or on warning labels, refer back to these Warnings. Product-specific hazard symbols and warnings not covered in this section may appear throughout the body of this manual where applicable.

 <h2 style="margin: 0;">WARNING</h2>	
   	<p><b>FIRE AND EXPLOSION HAZARD</b></p> <p>Flammable fumes, such as solvent and paint fumes, in <b>work area</b> can ignite or explode. Paint or solvent flowing through the equipment can cause static sparking. To help prevent fire and explosion:</p> <ul style="list-style-type: none"> <li>• Use equipment only in well-ventilated area.</li> <li>• Eliminate all ignition sources, such as pilot lights, cigarettes, portable electric lamps, and plastic drop cloths (potential static sparking).</li> <li>• Ground all equipment in the work area. See <b>Grounding</b> instructions.</li> <li>• Never spray or flush solvent at high pressure.</li> <li>• Keep work area free of debris, including solvent, rags and gasoline.</li> <li>• Do not plug or unplug power cords, or turn power or light switches on or off when flammable fumes are present.</li> <li>• Use only grounded hoses.</li> <li>• Hold gun firmly to side of grounded pail when triggering into pail. Do not use pail liners unless they are anti-static or conductive.</li> <li>• <b>Stop operation immediately</b> if static sparking occurs or you feel a shock. Do not use equipment until you identify and correct the problem.</li> <li>• Keep a working fire extinguisher in the work area.</li> </ul>
 	<p><b>MOVING PARTS HAZARD</b></p> <p>Moving parts can pinch, cut or amputate fingers and other body parts.</p> <ul style="list-style-type: none"> <li>• Keep clear of moving parts.</li> <li>• Do not operate equipment with protective guards or covers removed.</li> <li>• Do not wear loose clothing, jewelry or long hair while operating equipment.</li> <li>• Equipment can start without warning. Before checking, moving, or servicing equipment, follow the <b>Pressure Relief Procedure</b> and disconnect all power sources.</li> </ul>
	<p><b>SPECIAL CONDITIONS FOR SAFE USE</b></p> <ul style="list-style-type: none"> <li>• Electrostatic charging hazard. Clean surfaces with a damp cloth and read instructions for additional techniques to mitigate risk of electrostatic discharge.</li> <li>• The Ambient Temperature Range of each agitator depends on the air motor included in the assembly. Refer to <b>Models</b> and <b>Technical Specifications</b> in Instruction manual for additional information.</li> </ul>

# **WARNING**

 	<p><b>EQUIPMENT MISUSE HAZARD</b> Misuse can cause death or serious injury.</p> <ul style="list-style-type: none"> <li>• Do not operate the unit when fatigued or under the influence of drugs or alcohol.</li> <li>• Do not exceed the maximum working pressure or temperature rating of the lowest rated system component. See <b>Technical Specifications</b> in all equipment manuals.</li> <li>• Use fluids and solvents that are compatible with equipment wetted parts. See <b>Technical Specifications</b> in all equipment manuals. Read fluid and solvent manufacturer's warnings. For complete information about your material, request Safety Data Sheets (SDSs) from distributor or retailer.</li> <li>• Do not leave the work area while equipment is energized or under pressure.</li> <li>• Turn off all equipment and follow the <b>Pressure Relief Procedure</b> when equipment is not in use.</li> <li>• Check equipment daily. Repair or replace worn or damaged parts immediately with genuine manufacturer's replacement parts only.</li> <li>• Do not alter or modify equipment. Alterations or modifications may void agency approvals and create safety hazards.</li> <li>• Make sure all equipment is rated and approved for the environment in which you are using it.</li> <li>• Use equipment only for its intended purpose. Call your distributor for information.</li> <li>• Route hoses and cables away from traffic areas, sharp edges, moving parts, and hot surfaces.</li> <li>• Do not kink or over bend hoses or use hoses to pull equipment.</li> <li>• Keep children and animals away from work area.</li> <li>• Comply with all applicable safety regulations.</li> </ul>
 	<p><b>TOXIC FLUID OR FUMES HAZARD</b> Toxic fluids or fumes can cause serious injury or death if splashed in the eyes or on skin, inhaled, or swallowed.</p> <ul style="list-style-type: none"> <li>• Read Safety Data Sheets (SDSs) to know the specific hazards of the fluids you are using.</li> <li>• Store hazardous fluid in approved containers, and dispose of it according to applicable guidelines.</li> </ul>
	<p><b>PERSONAL PROTECTIVE EQUIPMENT</b> Wear appropriate protective equipment when in the work area to help prevent serious injury, including eye injury, hearing loss, inhalation of toxic fumes, and burns. Protective equipment includes but is not limited to:</p> <ul style="list-style-type: none"> <li>• Protective eyewear, and hearing protection.</li> <li>• Respirators, protective clothing, and gloves as recommended by the fluid and solvent manufacturer.</li> </ul>

# Installation

				
<p>To reduce the risk of fire and explosion, always maintain a minimum of 1 in. (25.4 mm) clearance between the rotating agitator parts and the container to prevent sparks from contact.</p>				

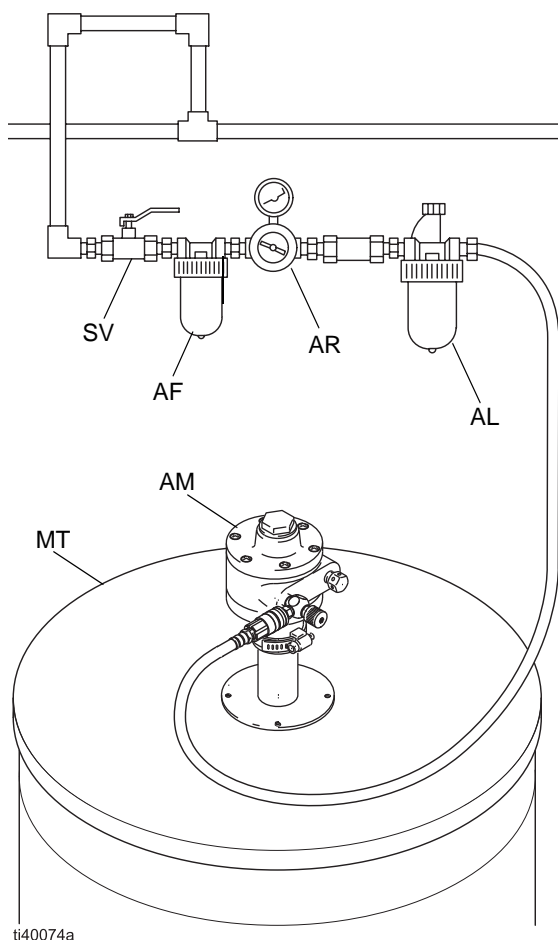

**Fig. 1: Typical Installation**

**Key:**

- SV: Bleed-type air shutoff valve
- AF: Air line filter
- AR: Air regulator and gauge
- AL: Air line lubricator
- AM: Agitator motor
- MT: Mix tank (reference only)

## Air Requirements

HP Motor Size	Typical Air Requirement for Continued Use
3/4 HP (550 W)	3 to 4 cfm (0.08 to 0.12 m <sup>3</sup> /min)
1 1/2 HP (1100 W)	6 to 8 cfm (0.17 to 0.23 m <sup>3</sup> /min)

## Air Line Accessories

A bleed-type air shutoff valve (SV) is required; it isolates the air line components for servicing. The air shutoff valve should be installed in the supply line and can be used to stop and start the agitator. If the valve is used to stop and start the agitator, you do not need to set the agitator speed each time it is used.

Order air shutoff valves by the part numbers listed below:

- 110223** 1/4" npt(f) x 1/4" npt(f)
- 110224** 3/8" npt(f) x 3/8" npt(f)
- 113333** 3/8" npt(m) x 3/8" npt(f)

Part	Description	Purpose
106148	Air line Filter (AF)‡	Removes harmful dirt and moisture from the air supply.
169969	Air Line Fitting (24)*	Shuts off main air to the air line.
208536	Air Line Coupler (23)*	
214847	Air Line Lubricator (AL)‡	Lubricates the air motor automatically.

\* Not included with Model 207953

‡ Sold separately

## Install Air Line Accessories

1. Attach the quick-disconnect air line fitting (24) and coupler (23) or attach a ball valve to the air line.
2. Install an air line filter (AF).
3. Install an air line lubricator (AL) downstream from the filter.

### NOTICE

Not lubricating the air motor will cause air motor failure.

4. Set the lubricator feed rate at 1 drop of oil per minute for high speed or continuous duty usage. Do not overfeed oil or the exhaust air may become contaminated.

If an air line lubricator is not installed, then the agitator must be manually lubricated. See **Lubricate the Air Motor**, page 9.

## Install the Agitator on the Drum

**NOTE:** The mounting gasket is not included with the agitator. To order, see **Mounting Hole Layout** on page 16 for the gasket part number.

1. Bolt the agitator onto the cover of the fluid supply tank with the gasket in place. Position the agitator so that the air line can be attached easily and will not obstruct other tank openings, lines, etc. See **Dimensions** and **Mounting Hole Layout** on page 16.
2. Connect the air hose as described in the following sections:
  - **Models 206758 and 222698**
  - **Model 206760**
  - **Model 207953**

### Models 206758 and 222698

Connect the fixed end of the supplied air hose (18) to the air control valve (1) and the swivel end to the air supply.

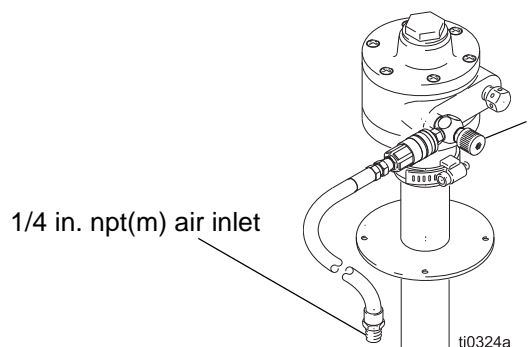

**FIG. 2: Models 206758 and 222698: Air Inlet**

### Model 206760

Connect a 0.25 in. (6.4 mm) minimum ID air hose to the 1/4 in. npt(f) quick coupler (23).

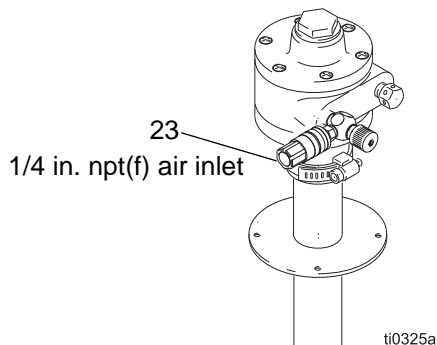

**FIG. 3: Model 206760: Air Inlet**

### Model 207953

Connect a 1/8 in. npt(m) air hose from the air supply to the air control valve (1) on the air motor.

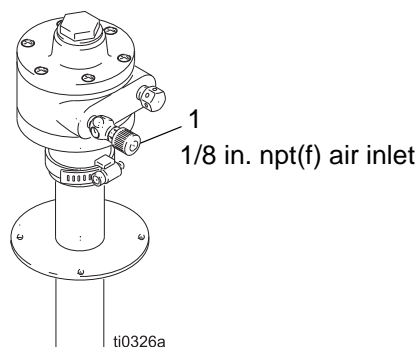

**FIG. 4: Model 207953: Air Inlet**

## Grounding



The equipment must be grounded to reduce the risk of static sparking. Static sparking can cause fumes to ignite or explode. To reduce the risk of static sparking, all electrically conductive objects or devices in the spray area must be properly grounded.

Check your local electrical code for detailed grounding instructions for your area and type of equipment.



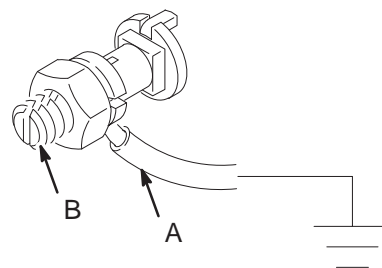

To ground the agitator, connect one end of the ground wire (A) to the ground connector (B) on the agitator. See FIG. 5. Connect the other end of the ground wire to a true earth ground.

For an additional ground wire and clamp, order part number 237569.



**FIG. 5: Ground the Agitator**

# Operation





				
<p>Moving parts, such as an impeller blade, can cut or amputate fingers. To reduce the risk of serious injury, always shut off the agitator and disconnect the air line before moving, checking, or repairing the agitator.</p>				

## Find the Proper Agitator Speed

**NOTE:** Attach ground wire before using agitator.

1. Fill the fluid supply container to about 3–4 inches (75–100 mm) above the agitator blade.
2. Start the agitator, and gradually increase the speed by turning the needle valve (1) until a vortex begins to form in the paint.
3. Reduce the speed slightly, then fill the fluid container. Use the lowest agitator speed needed for thorough agitation of the paint. Excessive agitator speed may cause the paint to foam.

## Pressure Relief Procedure

				
<p>This equipment stays pressurized until pressure is manually relieved. To help prevent serious injury from splashing fluid and moving parts, follow the Pressure Relief Procedure before cleaning, checking, or servicing the equipment.</p>				

1. Close the bleed-type air shutoff valve (SV) to relieve pressure to the air motor.
2. Disconnect the air line.

## Operate the Agitator

<b>NOTICE</b>
<p>To avoid damaging the equipment, do not operate the agitator at a high speed for a long period of time. Excessive agitator speed can cause foaming of fluid (making the fluid unusable), vibration, and increased wear on parts. Only agitate the fluid enough to maintain even mixing.</p>

Operate the agitator continuously while supplying paints or other fluids to the system.

Use the needle valve (1) to regulate the agitator speed. Set the agitator speed to thoroughly mix the paint, using the lowest speed possible.



To stop the agitator, close the bleed-type air shutoff valve (SV) in the air supply line or close the needle valve (1).





Stop the agitator and disconnect the air line before removing it from the pail.



# Maintenance

## Flush the Air Motor

				
Do not use kerosene or other flammable solvents to flush the air motor. Flushing with flammable solvents could cause fire or explosion and result in serious injury or property damage.				



				
Hazardous fluids or toxic fumes can cause serious injury or death if splashed in the eyes or on the skin, swallowed, or inhaled. When flushing the air motor:				
<ul style="list-style-type: none"> <li>• Perform the procedure in a well ventilated area.</li> <li>• Keep your face away from the exhaust port.</li> <li>• Wear the appropriate protective clothing, gloves, eyewear, and respirator.</li> </ul>				

If the air motor is sluggish or inefficient, follow this procedure.

The recommended solvent for air motors and lubricated pumps is Gast<sup>®</sup> Flushing Solvent (Gast part number AH255 or AH255A) or Inhibisol<sup>®</sup> Safety Solvent.

1. Disconnect the air line and muffler (14). See **Parts** on page 11.
2. Add several teaspoons of solvent, or spray the solvent directly into the motor.
3. Rotate the shaft by hand in both directions for a few minutes.
4. Reconnect the air line, and slowly increase the air pressure until there is not trace of solvent in the exhaust air.
5. Re-lubricate the motor with a squirt of lightweight oil in the chamber.

## Agitator Blades

				
Materials can become electrostatically charged when stirred or blended. To prevent fire and explosion, ground equipment and do not allow material to build up on agitator. Dried material could allow static build up and interfere with grounding.				

Regularly check the agitator for dried material buildup. Clean using a rag soaked in solvent that is compatible with the spray material and the surfaces being cleaned. Additionally, extra precautions need to be taken if using lower conductive materials (<1000 pS/m) such as:

- Avoid stirring/mixing at high speeds.
- Avoid insoluble mixtures.
- When possible, increase the material conductivity with additives.
- Use liquids with a high conductivity (>1000 pS/m).

## Lubricate the Air Motor

### NOTICE

Not lubricating the air motor will cause air motor failure.

If an air line lubricator (AL) is not installed, the air motor must be manually lubricated every 8 hours. Lubricate the agitator air motor by placing 10–20 drops of SAE #10 light oil in the motor's air inlet. Oil must have an auto-ignition rating of 365°F (185°C) or greater. Run the agitator for about 30 seconds.

## Clean the Shaft

Each week, clean any dried fluid from around the bearing (21) and housing (1a) area of the shaft (20).

## Service

If the unit requires more than installation of a service kit, it is usually quickest and easiest to send the unit to the Graco distributor for repair or replacement.

### **NOTICE**

Do not pry with a screwdriver. It will dent the surface of the plate and body, causing leaks. Use a puller tool, which will remove the end plate while maintaining the position of the shaft.

- If the vanes need replacing, or foreign material is present in the motor chamber, an experienced mechanic may remove the end plate opposite the drive shaft end.
- New vanes should have the edges with cut corners (or the notched edges, if the vanes are reversible) pointing toward the bottom of the vane slot.

**NOTE:** Air Motor Repair Kit is available. Order part number 207335 for agitators 206758, 207953, and 222698. Order part number 207336 for agitator 206760.

# Parts

## Model 206758

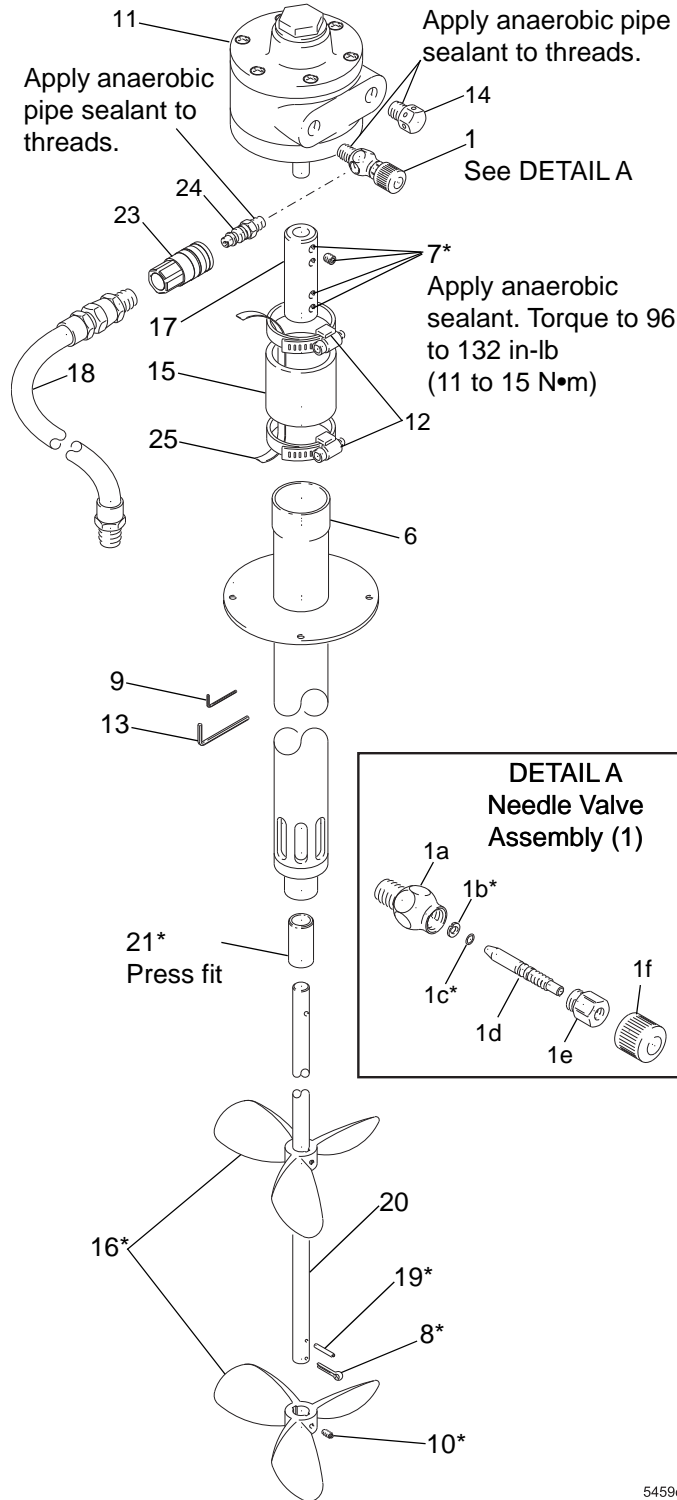

## Series A, Carbon steel agitator for 30-gallon mix tanks and 55-gallon drums

Ref	Part	Description	Qty.
1	206264	NEEDLE VALVE ASSEMBLY; Includes items 1a to 1f	1
1a	165722	HOUSING, air valve	1
1b*	166531	WASHER, friction	1
1c*	157628	O-RING; nitrile rubber	1
1d	166529	NEEDLE	1
1e	166532	NUT, packing	1
1f	164698	KNOB, adjusting	1
6	207622	GUIDE, agitator	1
7*	100053	SCREW, soc hd cup pt set; 5/16-18 x 1/4	4
8*	100579	PIN, cotter; 0.11 (2.8 mm) dia; 1 in. (25 mm) long	2
9	100633	WRENCH, hex key; 5/16 set screw size	1
10*	101118	SCREW, soc hd cup pt set; No.10- 24 x 1/2	2
11**	101140	MOTOR, air; 3/4 HP (550 W)	1
12	101368	CLAMP, hose	2
13	101369	WRENCH, hex key; No. 10 or 12 set screw	1
14	156969	MUFFLER, air exhaust	1
15	158865	COUPLER, rubber	1
16*	159854	PROPELLER; aluminum	2
17	159858	COUPLING, steel	1
18	206749	HOSE, air; cpld 1/8 in. npt x 1/4 in. npt (mbe), 1/4 in. (64 mm) I.D.; 36 in. (914 mm) long	1
19*	160077	PIN, shear	2
20	172313	SHAFT, agitator	1
21*	166565	BEARING, PTFE	1
23	114558	COUPLER, air line	1
24	169969	FITTING, air line	1
25	65251	WIRE, ground, braided; 3 in.	1
26▲	17P806	KIT, safety tag (not shown)	1

\* Keep spares of these parts on hand to reduce down time.

\*\* Air Motor Repair Kit is available. Order part number 207335.

▲ Replacement safety labels, tags, and cards are available at no cost.

5459c

# Model 206760

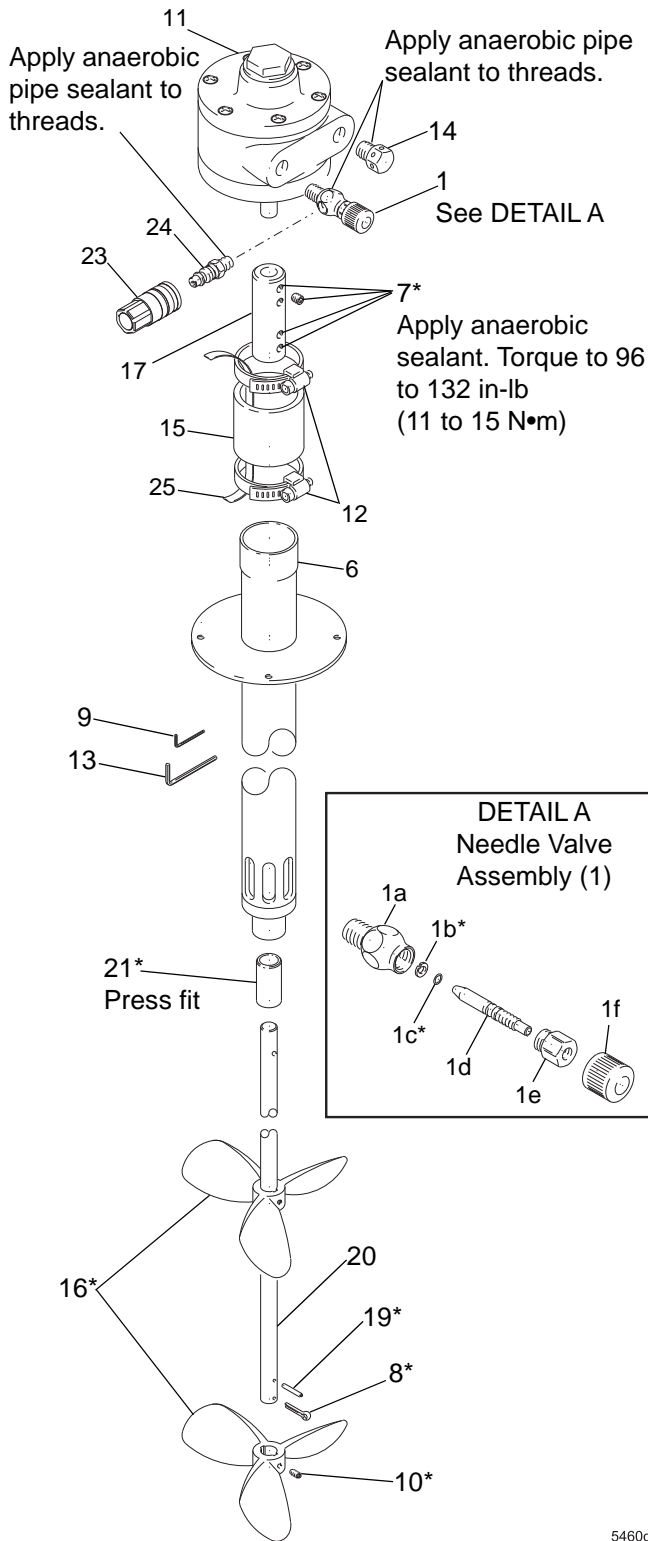

## Series A, Carbon steel agitator for 60-gallon mix tanks

Ref.	Part	Description	Qty.
1	206264	NEEDLE VALVE ASSEMBLY; Includes items 1a- 1f	1
1a	165722	HOUSING, air valve	1
1b*	166531	WASHER, friction	1
1c*	157628	O-RING; nitrile rubber	1
1d	166529	NEEDLE	1
1e	166532	NUT, packing	1
1f	164698	KNOB, adjusting	1
6	206759	GUIDE, agitator	1
7*	100053	SCREW, soc hd cup pt set; 5/16-18 x 1/4	4
8*	100579	PIN, cotter; 0.11 (2.8 mm) dia; 1 in. (25 mm) long	2
9	100633	WRENCH, hex key; 5/16 set screw size	1
10*	101118	SCREW, soc hd cup pt set; No.10- 24 x 1/2	2
11**	101388	MOTOR, air; 1 1/2 HP (1100 W)	1
12	101368	CLAMP, hose	2
13	101369	WRENCH, hex key; No. 10 or 12 set screw	1
14	156969	MUFFLER, air exhaust	1
15	158865	COUPLER, rubber	1
16*	159854	PROPELLER; aluminum	2
17	159858	COUPLING, steel	1
19*	160077	PIN, shear	2
20	172311	SHAFT, agitator	1
21*	166565	BEARING, PTFE	1
23	114558	COUPLER, air line	1
24	169969	FITTING, air line	1
25	65251	WIRE, ground, braided; 3 in.	1
26▲	17P806	KIT, safety tag (not shown)	1

\* Keep spares of these parts on hand to reduce down time.

\*\* Air Motor Repair Kit is available. Order part number 207336.

▲ Replacement safety labels, tags, and cards are available at no cost.

5460c

# Model 207953

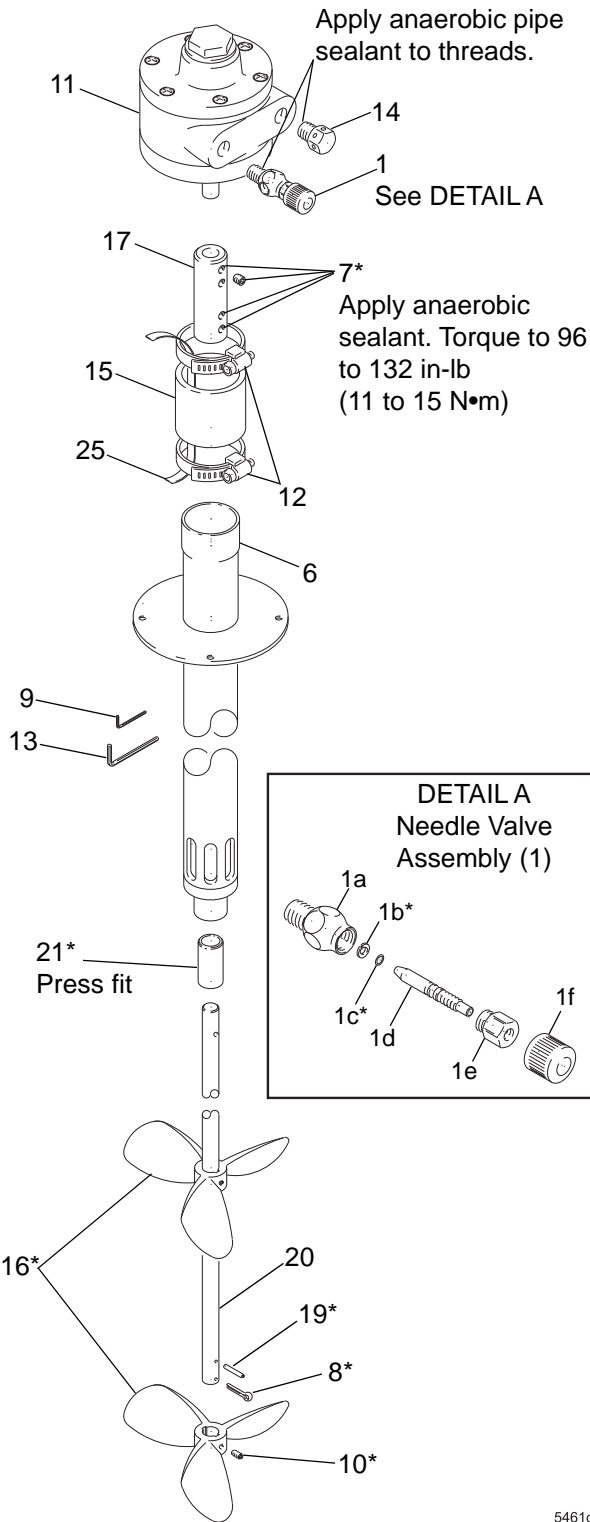

## Series A, Carbon steel agitator for 15-gallon mix tanks

Ref.	Part	Description	Qty.
1	206264	NEEDLE VALVE ASSEMBLY; Includes items 1a to 1f	1
1a	165722	HOUSING, air valve	1
1b*	166531	WASHER, friction	1
1c*	157628	O-RING; nitrile rubber	1
1d	166529	NEEDLE	1
1e	166532	NUT, packing	1
1f	164698	KNOB, adjusting	1
6	207431	GUIDE, agitator	1
7*	100053	SCREW, soc hd cup pt set; 5/16-18 x 1/4	4
8*	100579	PIN, cotter; 0.11 (2.8 mm) dia; 1 in. (25 mm) long	2
9	100633	WRENCH, hex key; 5/16 set screw size	1
10*	101118	SCREW, soc hd cup pt set; No.10-24 x 1/2	2
11**	101140	MOTOR, air; 3/4 HP (550 W)	1
12	101368	CLAMP, hose	2
13	101369	WRENCH, hex key; No. 10 or 12 set screw	1
14	156969	MUFFLER, air exhaust	1
15	158865	COUPLER, rubber	1
16*	159854	PROPELLER; aluminum	2
17	159858	COUPLING, steel	1
19*	160077	PIN, shear	2
20	172353	SHAFT, agitator	1
21*	166565	BEARING, PTFE	1
25	65251	WIRE, ground, braided; 3 in.	1
26▲	17P806	KIT, safety tag (not shown)	1

\* Keep spares of these parts on hand to reduce down time.

\*\* Air Motor Repair Kit is available. Order part number 207335.

▲ Replacement safety labels, tags, and cards are available at no cost.

5461c

# Model 222698

## Series A, Stainless steel agitator for 30-gallon mix tanks and 55-gallon drums

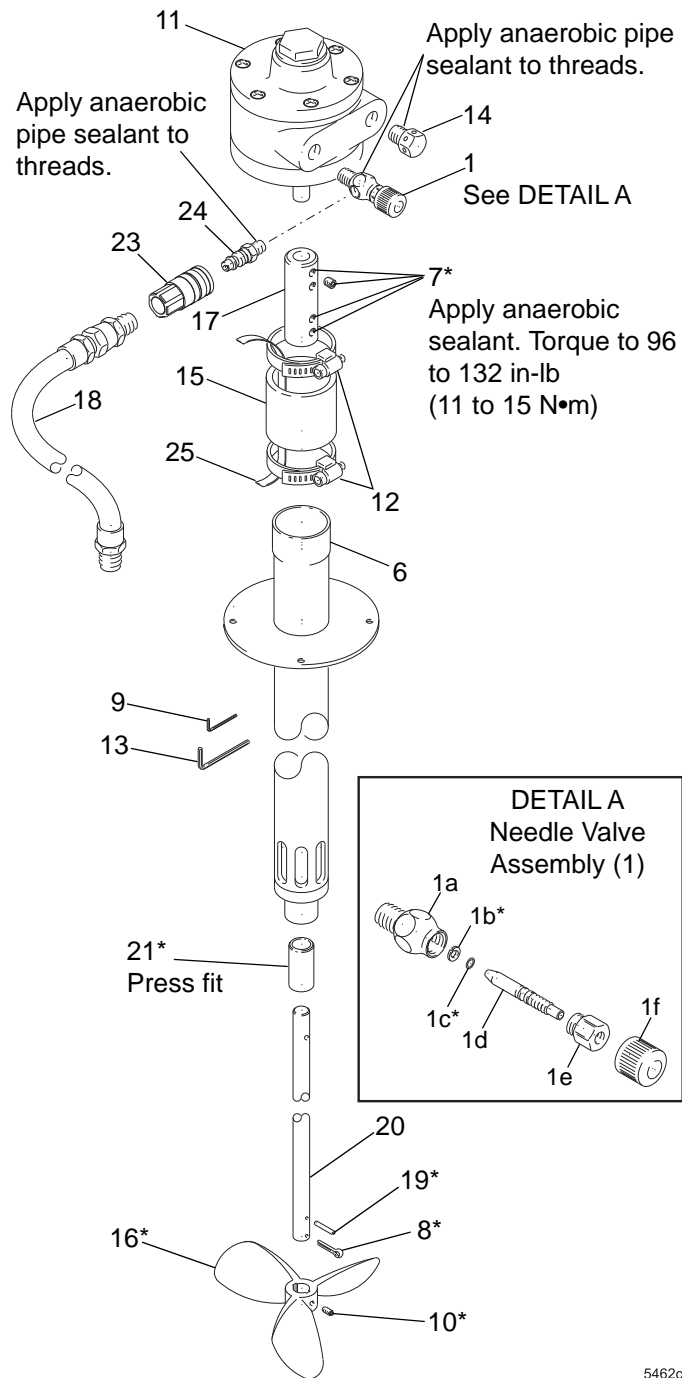

5462c

Ref.	Part	Description	Qty.
1	206264	NEEDLE VALVE ASSEMBLY; Includes items 1a to 1f	1
1a	165722	HOUSING, air valve	1
1b*	166531	WASHER, friction	1
1c*	157628	O-RING; nitrile rubber	1
1d	166529	NEEDLE	1
1e	166532	NUT, packing	1
1f	164698	KNOB, adjusting	1
6	222696	GUIDE, agitator	1
7*	100053	SCREW, soc hd cup pt set; 5/16-18 x 1/4	3
7*	100053	SCREW, soc hd cup pt set; 5/16-18 x 1/4	3
8*	100579	PIN, cotter; 0.11 (2.8 mm) dia; 1 in. (25 mm) long	1
9	100633	WRENCH, hex key; 5/16 set screw size	1
10*	110248	SCREW, soc hd cup pt set; No.10- 24 x 1/4	1
11**	101140	MOTOR, air; 3/4 HP (550 W)	1
12	101368	CLAMP, hose	2
13	101369	WRENCH, hex key; No. 10 or 12 set screw	1
14	156969	MUFFLER, air exhaust	1
15	158865	COUPLER, rubber	1
16*	185398	PROPELLER; stainless steel	1
17	159858	COUPLING, steel	1
18	206749	HOSE, air; cpld 1/8 in. npt x 1/4 in. npt (mbe), 1/4 in. (64 mm) I.D.; 36 in. (914 mm) long	1
19*	185401	PIN, shear	2
20	185389	SHAFT, agitator	1
21*	115166	BEARING	1
23	114558	COUPLER, air line	1
24	169969	FITTING, air line	1
25	65251	WIRE, ground, braided; 3 in.	1
26▲	17P806	KIT, safety tag (not shown)	1

\* Keep spares of these parts on hand to reduce down time.

\*\* Air Motor Repair Kit is available. Order part number 207335.

▲ Replacement safety labels, tags, and cards are available at no cost.

# Performance Charts

**NOTE:** Lines on the graphs show air inlet pressure.

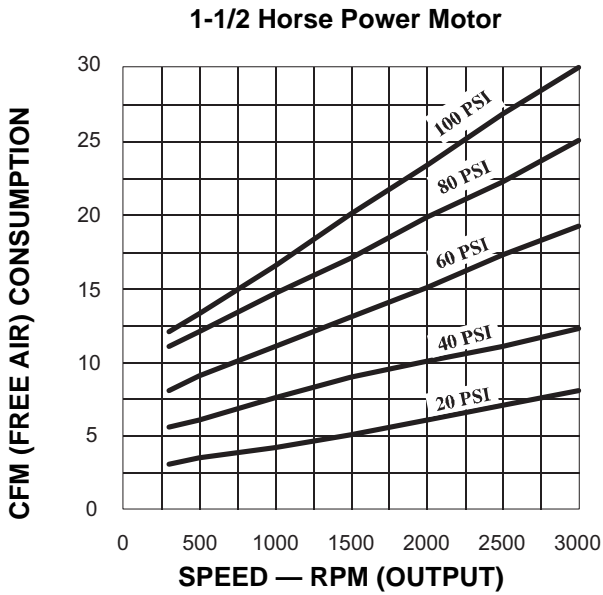
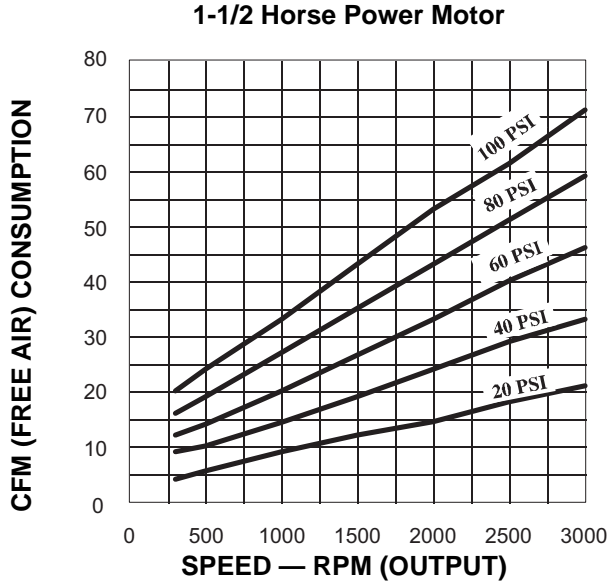

# Dimensions

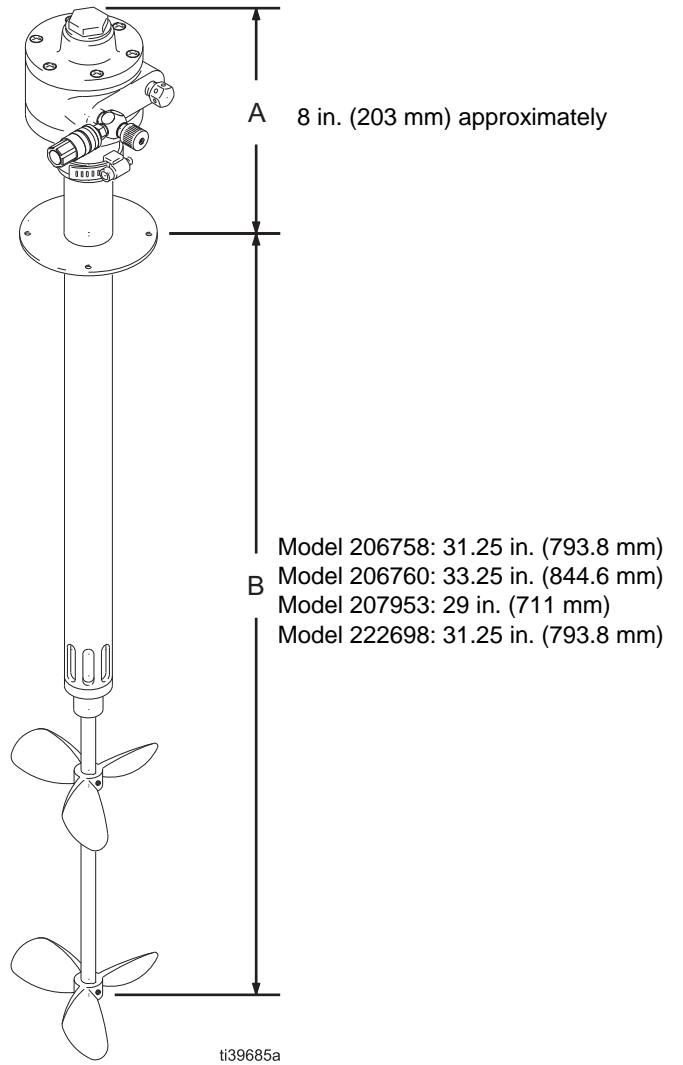

**Fig. 6: Dimensions**

# Mounting Hole Layout

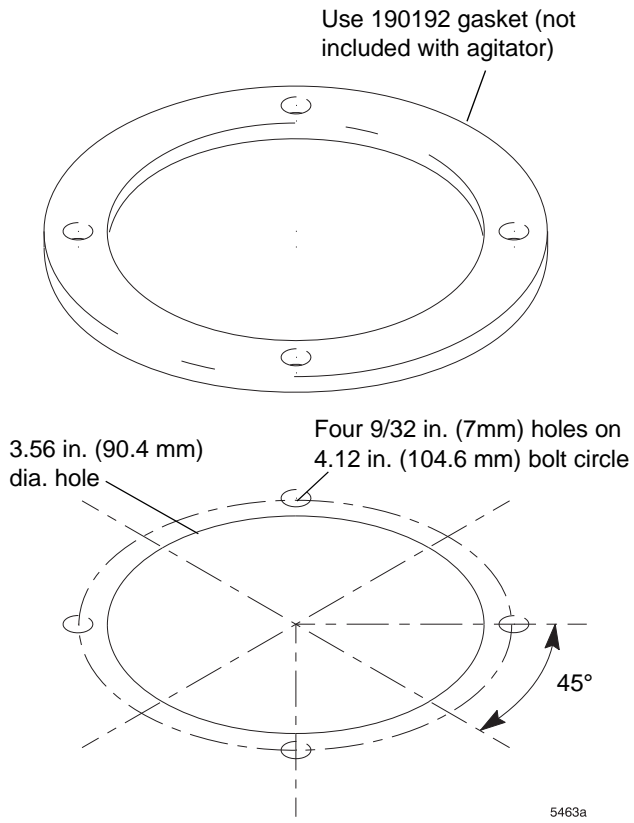

**FIG. 7: Mounting Hole Layout**



# Technical Specifications

<b>Air-Driven Agitators</b>		
	<b>US</b>	<b>Metric</b>
Maximum working pressure	100 psi	0.7 MPa, 7 bar
Maximum recommended speed	500 RPM	
Ambient operating temperature range	+33.8°F < Ta < +104°F	+1°C < Ta < +40°C
Motor power rating		
Models 206758, 207953, and 222698	3/4 HP (550 W)	
Model 206760	1 1/2 HP (1100 W)	
Air consumption	See <b>Performance Charts</b> , page 15	
<b>Noise (dBA)</b>		
* Sound level at 800R PM, 100 psi, normal load		
Pressure level	66.8 dB(A)	
Power level	79.9 dB(A)	
* Sound level at maximum RPM, 100 psi, no load		
Pressure level	86.2 dB(A)	
Power level	99.4 dB(A)	
* Tested to CAGI-PNEUROP-1969.		
<b>Materials of Construction (wetted parts)</b>		
Models 206758, 207953, and 206760	Aluminum, PTFE, carbon steel	
Model 222698	Stainless steel, polyether ether ketone	
<b>Weight</b>		
Model 222698	9.9 lb	4.5 kg
<b>Notes</b>		
All trademarks or registered trademarks are the property of their respective owners.		

## California Proposition 65

### CALIFORNIA RESIDENTS

 **WARNING:** Cancer and reproductive harm – [www.P65warnings.ca.gov](http://www.P65warnings.ca.gov).

# Graco Standard Warranty

Graco warrants all equipment referenced in this document which is manufactured by Graco and bearing its name to be free from defects in material and workmanship on the date of sale to the original purchaser for use. With the exception of any special, extended, or limited warranty published by Graco, Graco will, for a period of twelve months from the date of sale, repair or replace any part of the equipment determined by Graco to be defective. This warranty applies only when the equipment is installed, operated and maintained in accordance with Graco's written recommendations.

This warranty does not cover, and Graco shall not be liable for general wear and tear, or any malfunction, damage or wear caused by faulty installation, misapplication, abrasion, corrosion, inadequate or improper maintenance, negligence, accident, tampering, or substitution of non-Graco component parts. Nor shall Graco be liable for malfunction, damage or wear caused by the incompatibility of Graco equipment with structures, accessories, equipment or materials not supplied by Graco, or the improper design, manufacture, installation, operation or maintenance of structures, accessories, equipment or materials not supplied by Graco.

This warranty is conditioned upon the prepaid return of the equipment claimed to be defective to an authorized Graco distributor for verification of the claimed defect. If the claimed defect is verified, Graco will repair or replace free of charge any defective parts. The equipment will be returned to the original purchaser transportation prepaid. If inspection of the equipment does not disclose any defect in material or workmanship, repairs will be made at a reasonable charge, which charges may include the costs of parts, labor, and transportation.

**THIS WARRANTY IS EXCLUSIVE, AND IS IN LIEU OF ANY OTHER WARRANTIES, EXPRESS OR IMPLIED, INCLUDING BUT NOT LIMITED TO WARRANTY OF MERCHANTABILITY OR WARRANTY OF FITNESS FOR A PARTICULAR PURPOSE.**

Graco's sole obligation and buyer's sole remedy for any breach of warranty shall be as set forth above. The buyer agrees that no other remedy (including, but not limited to, incidental or consequential damages for lost profits, lost sales, injury to person or property, or any other incidental or consequential loss) shall be available. Any action for breach of warranty must be brought within two (2) years of the date of sale.

**GRACO MAKES NO WARRANTY, AND DISCLAIMS ALL IMPLIED WARRANTIES OF MERCHANTABILITY AND FITNESS FOR A PARTICULAR PURPOSE, IN CONNECTION WITH ACCESSORIES, EQUIPMENT, MATERIALS OR COMPONENTS SOLD BUT NOT MANUFACTURED BY GRACO.** These items sold, but not manufactured by Graco (such as electric motors, switches, hose, etc.), are subject to the warranty, if any, of their manufacturer. Graco will provide purchaser with reasonable assistance in making any claim for breach of these warranties.

In no event will Graco be liable for indirect, incidental, special or consequential damages resulting from Graco supplying equipment hereunder, or the furnishing, performance, or use of any products or other goods sold hereto, whether due to a breach of contract, breach of warranty, the negligence of Graco, or otherwise.

## **FOR GRACO CANADA CUSTOMERS**

The Parties acknowledge that they have required that the present document, as well as all documents, notices and legal proceedings entered into, given or instituted pursuant hereto or relating directly or indirectly hereto, be drawn up in English. Les parties reconnaissent avoir convenu que la rédaction du présente document sera en Anglais, ainsi que tous documents, avis et procédures judiciaires exécutés, donnés ou intentés, à la suite de ou en rapport, directement ou indirectement, avec les procédures concernées.

# Graco Information

For the latest information about Graco products, visit [www.graco.com](http://www.graco.com).

For patent information, see [www.graco.com/patents](http://www.graco.com/patents).

TO PLACE AN ORDER, contact your Graco distributor or call to identify the nearest distributor.

Phone: 612-623-6921 or Toll Free: 1-800-328-0211, Fax: 612-378-3505

*All written and visual data contained in this document reflects the latest product information available at the time of publication.  
Graco reserves the right to make changes at any time without notice.*

Original instructions. This manual contains English. MM 306840

**Graco Headquarters:** Minneapolis

**International Offices:** Belgium, China, Japan, Korea

**GRACO INC. AND SUBSIDIARIES • P.O. BOX 1441 • MINNEAPOLIS MN 55440-1441 • USA**  
**Copyright 1964, Graco Inc. All Graco manufacturing locations are registered to ISO 9001.**

[www.graco.com](http://www.graco.com)  
Revision S, August 2021