



Fiber Reinforced Plastic is used in many markets.

FRP Systems

PROPORTIONERS AND GUNS

FOR GEL COAT AND CHOP APPLICATIONS

PROVEN QUALITY. LEADING TECHNOLOGY.

Industry-leading solutions for FRP

You wouldn't head out on the open water with anything less than the strongest, most sea-worthy boat. For all the same reasons, you should be just as careful about selecting dispensing equipment for fiber reinforced plastics (FRP).

- **Proven technological superiority.**
- **Quality parts and construction.**
- **Exacting performance standards.**

Graco delivers these qualities whether you're spraying chop into a hull or gel coat on an automobile. Our products are simply the best, backed by our team of technicians and service staff who are committed to keeping you up and running. With Graco, you'll never feel adrift.

We're committed to finding you the **right solution.**



Chop System

Raising the bar for high-performance

Engineered with industry-proven Graco components, Graco FRP (Fiber-Reinforced Plastic) Systems and RS™ (resin spray) applicator guns provide you with a system that is technologically advanced, durable and easy to use.

Our Chop and Gel Coat Systems can give you a more consistent spray pattern, monitor resin usage and provide time-saving, tool-free adjustments.

Optional inline heaters provide consistent temperature and viscosity control at the point of application

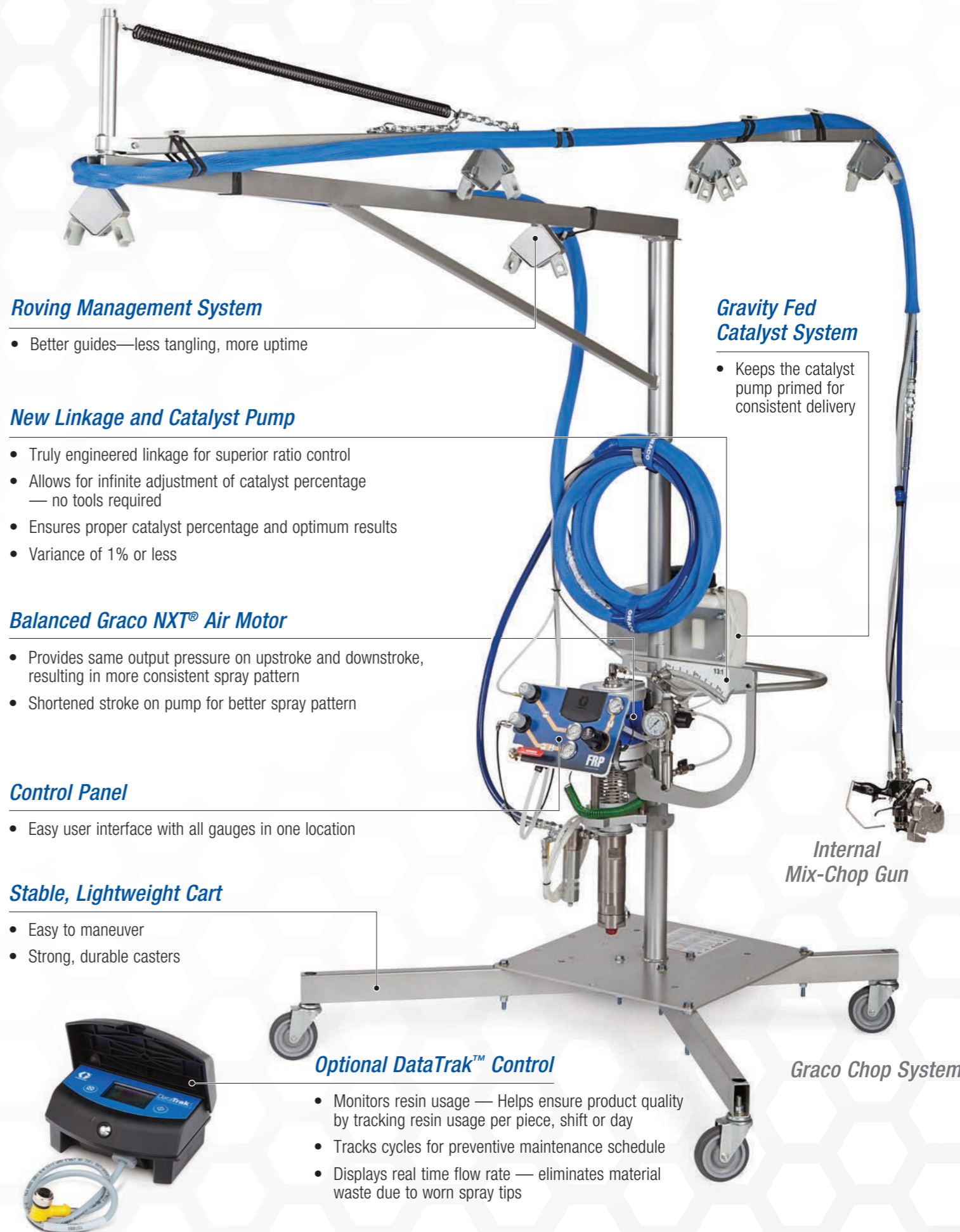

Roving Management System

- Better guides—less tangling, more uptime

New Linkage and Catalyst Pump

- Truly engineered linkage for superior ratio control
- Allows for infinite adjustment of catalyst percentage — no tools required
- Ensures proper catalyst percentage and optimum results
- Variance of 1% or less

Balanced Graco NXT® Air Motor

- Provides same output pressure on upstroke and downstroke, resulting in more consistent spray pattern
- Shortened stroke on pump for better spray pattern

Control Panel

- Easy user interface with all gauges in one location

Stable, Lightweight Cart

- Easy to maneuver
- Strong, durable casters

Optional DataTrak™ Control

- Monitors resin usage — Helps ensure product quality by tracking resin usage per piece, shift or day
- Tracks cycles for preventive maintenance schedule
- Displays real time flow rate — eliminates material waste due to worn spray tips

Gravity Fed Catalyst System

- Keeps the catalyst pump primed for consistent delivery

Internal Mix-Chop Gun

Graco Chop System



Consistent ratio for a consistent cure

Lower cost of ownership

- Easy maintenance—fewer wear parts than competitive models
- More uptime for production—longer periods between scheduled maintenance

Quality parts—all day, every day

Your reputation rides on the quality of your end products. With Graco FRP equipment, you're assured of a consistent catalyst ratio for a consistent cure—resulting in higher quality, finished products.

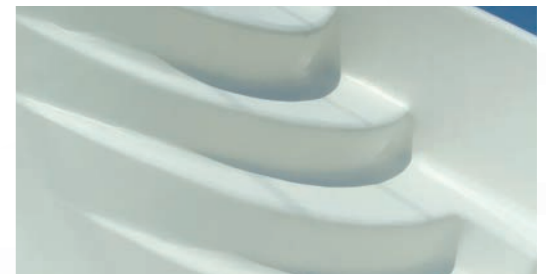
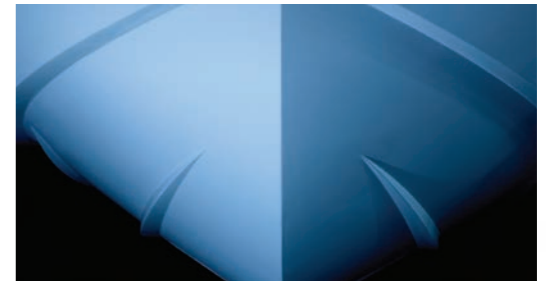

Stay on ratio. Stop waste.

A smart future investment: MACT-compliant technology.

Graco FRP equipment features MACT (Maximum Achievable Control Technologies) – compliant RS spray guns. As regulations change to require new technologies, Graco promises to be a smart investment for the future of your business.

Here's why. Graco FRP equipment supports MACT requirements with two application tip designs—one for air assisted airless and a second one for impingement spray processes. With Graco, you can switch from air assisted airless to impingement by simply changing the spray tip.



Increase uptime. Reduce downtime.

Easy to use, lightweight guns

Magnetic Cutter Drum

- Quick and easy blade changes
- Magnet in cutter head holds blades in place

Swivel Feature

(Where the fluid line connects to the gun)

- Allows smooth movement
- Operator can easily pivot in different directions without kinking the hose

Ergonomic Handle

- Less operator fatigue

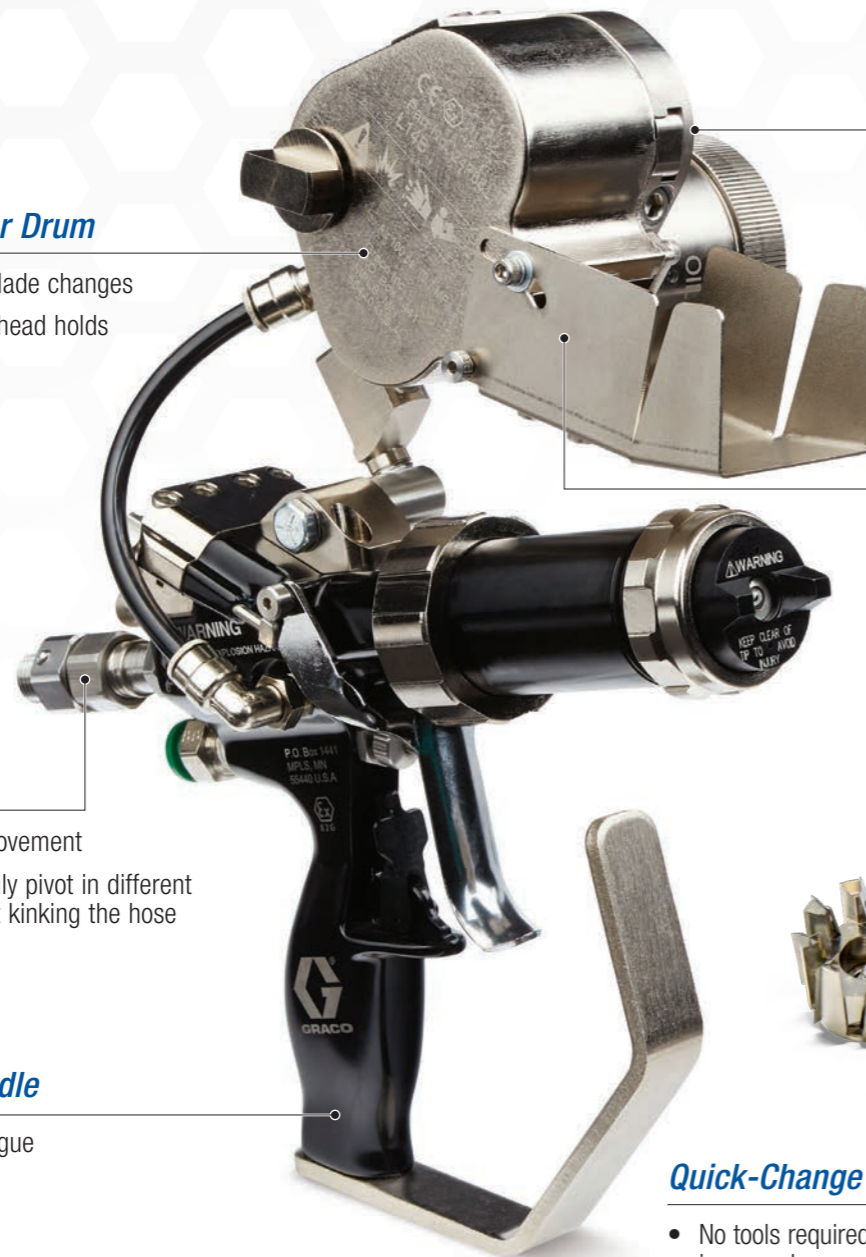

Graco RS Chop Gun
with Cutter

Constant Control

- Adjust glass cutting tension output on the production floor in seconds
- No tools needed to make many adjustments

Lightweight, High-Output Cutter

- Allows you to get the glass output you need with fewer strands of roving
- Fewer strands of roving means less chance of tangling, easier handling and more uptime
- External anvil adjustment lets you quickly and easily adjust anvil tension

Quick-Change Blade Assembly

- No tools required – easy to change blades in seconds
- Ability to quickly swap preloaded cutter assembly on the production line resulting in more uptime
- Magnetic cutter assembly snaps and holds blades in place during change out to reduce nicks and cuts
- Only available at Graco!



Discover the next generation gel coat gun.

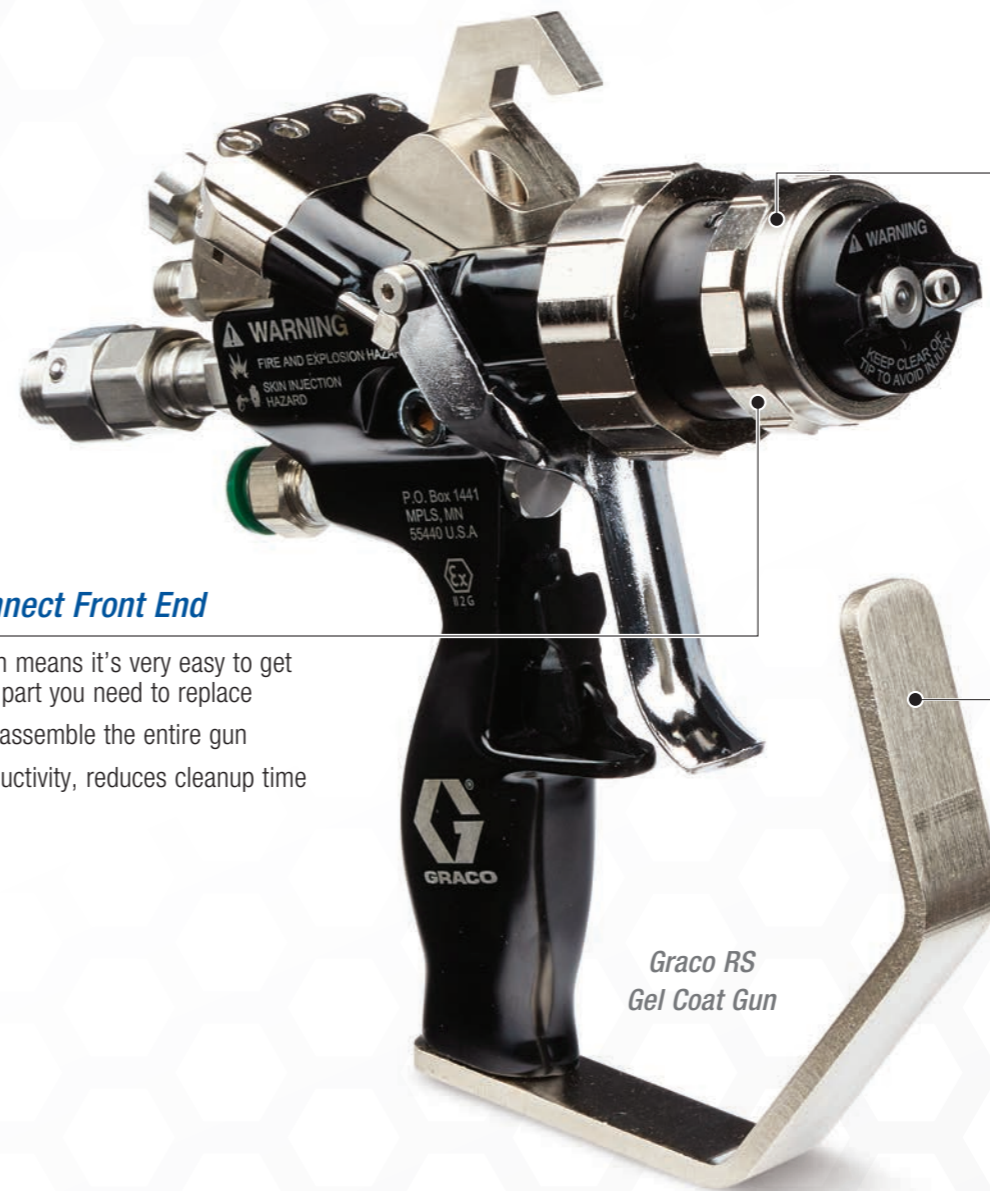

Quick-Disconnect Front End

- Modular design means it's very easy to get to the specific part you need to replace
- No need to disassemble the entire gun
- Increases productivity, reduces cleanup time

Solvent-Safe

- Easy shutdown — simply place front end in solvent at end of shift

Engineered Innovation

- Lightweight, ergonomic, designed for tool-less operation and fast, easy maintenance

Graco RS
Gel Coat Gun

Less material waste. More profitability.

Both Graco RS Gel Coat Guns and Graco RS Chop Guns are available in internal and external mix models

EXCLUSIVE GRACO FEATURE

Fast switch tip design

Today's FRP market uses two different technologies. Mechanical Air Atomized (Air Assisted Airless) and Mechanical Non-Air Atomized (Impingement). Using the Graco RS Guns allows you to switch from one technology to the other by simply changing the spray tip. This can be done quickly and cost effectively. Competitive models require time-consuming spray gun head changes and or complete replacement of the spray gun which results in lost time and higher cost conversion.



Impingement Tip



OR

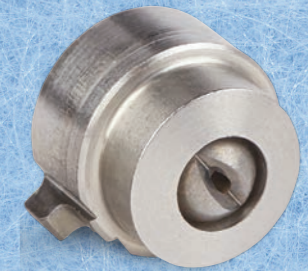

Air Assisted Airless Tip

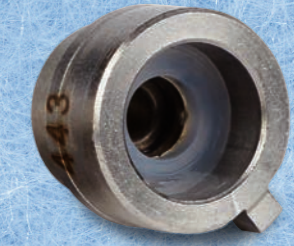

Only Graco allows you to switch technologies just by changing tips



EXCLUSIVE GRACO FEATURE

AAC Spray Control Technology

Air Assist Containment® (AAC) – control and contain your spray pattern

When you buy a drum of resin or gelcoat, you pay for every drop of material. Graco will help you put as many of those drops as possible on the mold.

Our exclusive **Air-Assist Containment (AAC)** wraps the spray pattern in a containment shield of air. This prevents atomized droplets from escaping the spray pattern creating a better working environment.

Droplets that escape and end up on the floor, wall or employee's clothing are a waste of money. AAC creates a spray pattern where the droplets travel to the mold at very low pressure. The low speed or "particle velocity" creates very little turbulence or disturbance in the material when it is applied to the mold. Competitive spray guns with higher "particle velocity", create a great deal of turbulence during the application process. Turbulence, or over-atomization, creates air entrapment which can result in porosity issues.

YES

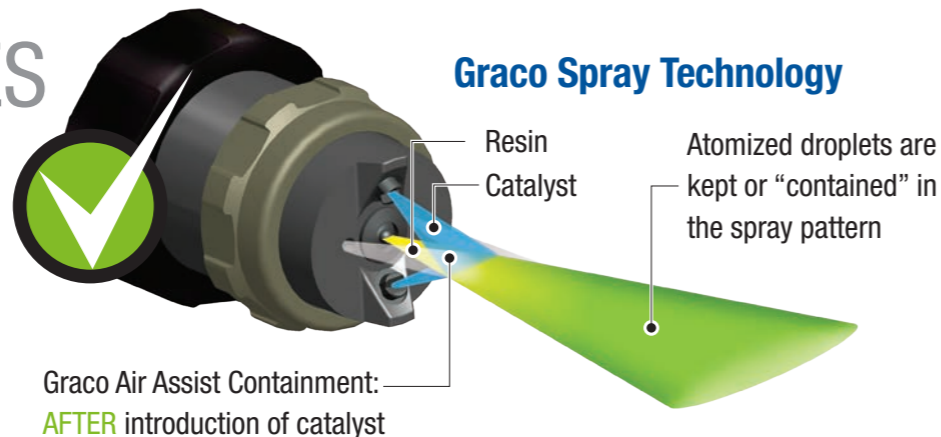

NO

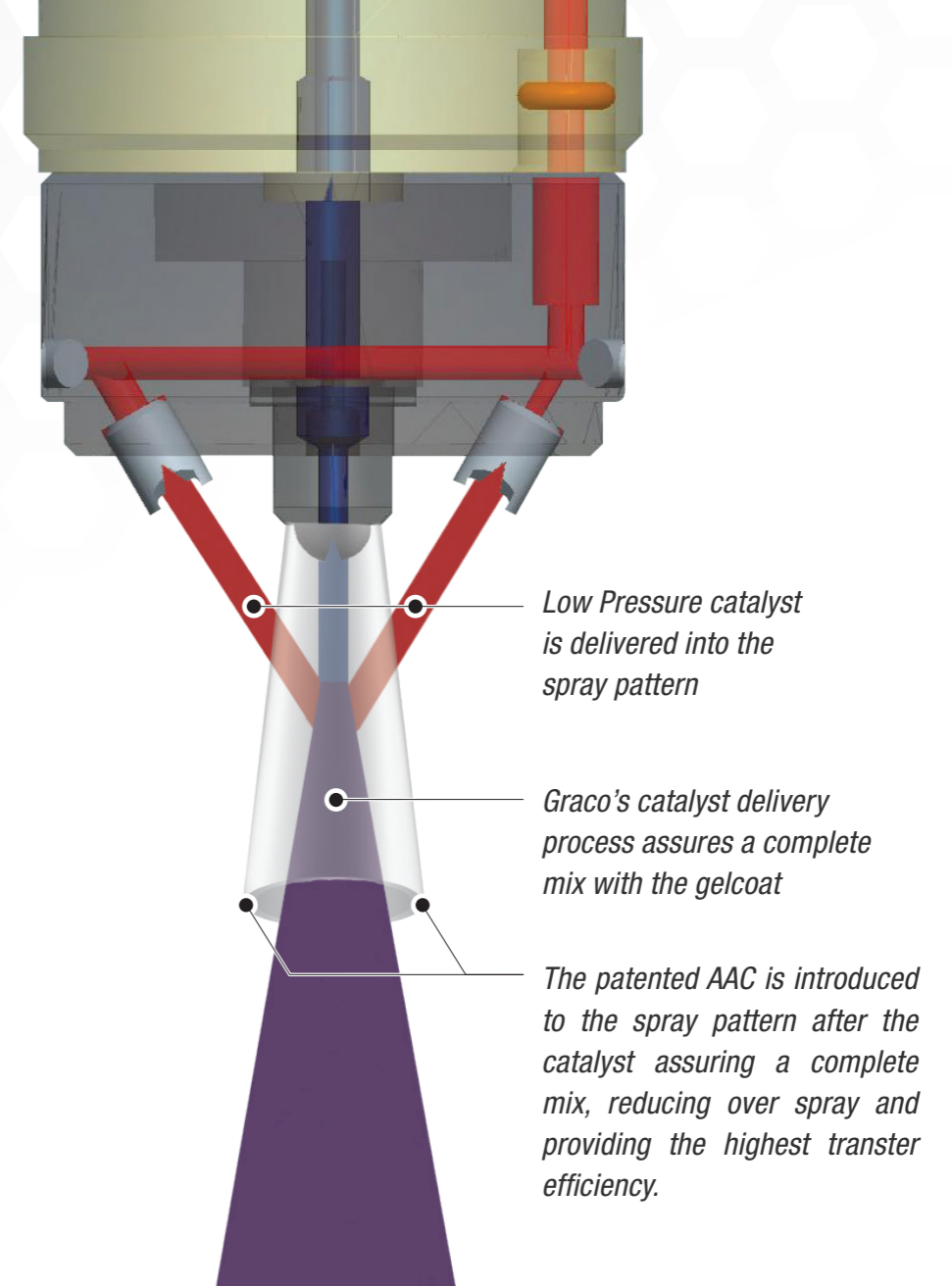
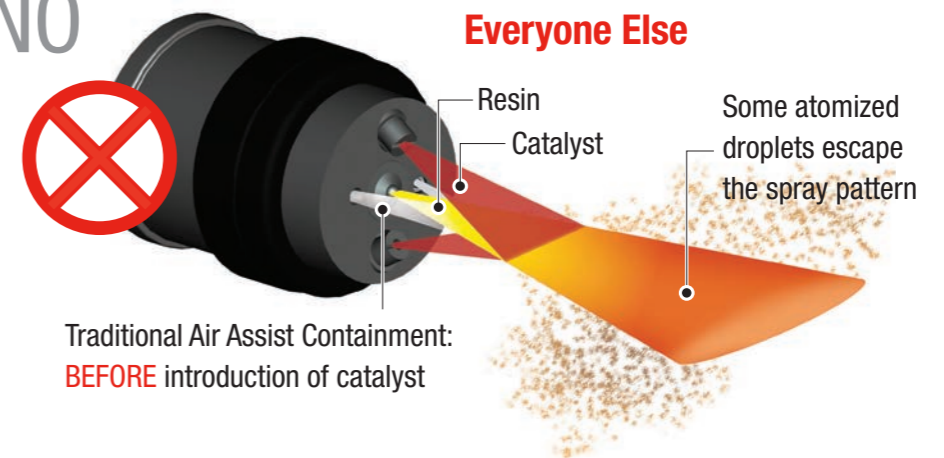

Graco Guns + Accessories



RS Gun Parts

Optional Cutter Chutes

Head Assemblies

Gun Kits

RS Guns

- 258853 RS Internal Mix Gel Coat Gun, CST521 tip
- 258840 RS External Mix Gel Coat Gun, CST521 tip
- 258971 RS Internal Mix Chop Gun with Cutter, CST443 tip
- 258970 RS External Mix Chop Gun with Cutter, CST443 tip
- 258854 RS Internal Mix Chop Gun without Cutter, CST443 tip
- 258852 RS External Mix Chop Gun without Cutter, CST443 tip
- 24P435 RS Internal Mix Chop Gun (High Flow) with Cutter, CST561 tip
- 24P436 RS Internal Mix Chop Gun (High Flow) w/o Cutter, CST561 tip



RS Gun Parts

- 24E512 Cutter assembly
- 24R482 Cutter Head Assembly
- 24R6060 100-Pack of Cutter Blades
- 123672 Anvil - Cartridge Cutter Head
- 126995 Anvil - Individual Blade Cutter Head
- 16K768 RS RTM and Pour Adapter
- 24H337 Internal Mix High Flow Kit
- 24H336 External Mix High Flow Kit
- 24M569 Roving guide, 2-hole feeder bar

Optional Cutter Chutes

- 16K759 Open, Short, Adjustable Chute
- 16K760 Closed, Short, Adjustable Chute
- 16K762 Open, Long, Adjustable Chute
- 16K763 Closed, Long, Adjustable Chute
- 125883 Closed, Long, Wide Chute
- 125884 Closed, Narrow Chute

Head Assemblies

- 24E426 External Mix Horizontal Front Head Kit
- 24E427 External Mix Vertical Front Head Kit
- 24E442 Internal Mix Chop Front Head Kit
- 24G615 Internal Mix Gel Front Head Kit

Gun Kits

- 24E415 Solvent AAC assembly fitting kit
- 24E416 Needle clamp assembly kit
- 24E417 Complete needle assembly
- 24E418 Needle repair kit
- 24E419 Needle AAC kit
- 24E420 Catalyst Seat Kit
- 24E421 Resin Seat Kit
- 24E422 Cutter adapter kit
- 24E423 Catalyst check valve
- 24E424 Check valve housing kit
- 24E425 Trigger air valve kit
- 24E428 Seat seal, 6-pack
- 24E435 Tip seal kit, 6-pack
- 24E436 Needle assembly kit, 6-pack
- 24E443 Front head internal check valve
- 24E444 Internal spring check valve kit
- 24E445 Internal mixer kit
- 24E446 Front head external check valve kit
- 24E447 Front head external check valve repair kit
- 24F706 Chopper Air Shutoff Valve
- 16N889 Carbide seat kit
- 24Y928 RS Gun ratio check kit



Spray Tips

HOW TO READ A COMPOSITE SPRAY TIP NUMBER

Airless Composites Spray Tips - For example: CST521

1. The first three letters (CST) = Composite Spray Tip.
2. The 4th digit indicates pattern width code.
Double this number to get the pattern width at 12 inches.
In this case, 5 equals a 10-inch spray pattern width at a 12-inch spraying distance.
3. The last two digits indicates orifice size.
In this case, 21 is equivalent to a .021" diameter orifice.

Airless Composite Spray Tips (CSTXXX)

		ORIFICE SIZE - INCHES												
	IN (MM)	0.015	0.017	0.019	0.021	0.023	0.027	0.031	0.035	0.043	0.051	0.061	0.071	
Fan Width	4	102	215	217	219	221	223	227	231	235				
	6	152	315	317	319	321	323	327	331	335	343	351		
	8	203	415	417	419	421	423	427	431	435	443	451	461	471
	10	254	515	517	519	521	523	527	531	535	543	551	561	571
	12	305	615	617	619	621	623	627	631	635	643	651	661	671

Impingement Composite Spray Tips - For example: CSTS75

1. The first three letters (CST) = Composite Spray Tip.
2. The 4th digit indicates S for stainless steel or T for tool steel.
3. The 5th digit indicates spray pattern width code.
Double the number to get pattern width at 18 inches.
In this case, 7 equals a 14-inch pattern width at an 18-inch spraying distance.

Impingement Composite Spray Tips (CSTXXX)

		ORIFICE SIZE - INCHES								
	IN (MM)	0.018	0.021	0.036	0.042	0.052	0.062	0.070	0.081	
Fan Width	6	152	S31	S32	S33	S34	S35	S36, T36	S37, T37	
	8	203	S41	S42	S43	S44	S45	S46, T46	S47, T47	
	10	254	S51	S52	S53	S54	S55	S56, T56	S57, T57	S58
	12	305	S61	S62	S63	S64	S65	S66, T66	S67, T67	S68
	14	356	S71	S72	S73	S74	S75	S76, T76	S77	S78
	16	406	S81	S82	S83	S84	S85	S86, T86	S87	S88
	18	457	S91	S92						



Graco Systems

13:1 Ratio

Max Air Consumption** - 35 SCFM
Max Fluid Output** - 1.5gpm
(5.7 lpm)''

		No Cart/Hose Length*		Cart/Hose Length *		Cart, Mast and Boom/Hose Length *		
		Part #	ft (m)	Part #	ft (m)	Part #	ft (m)	
Internal Mix	Gel	16R065	25 (7.6)	16R002	25 (7.6)	16R053	25 (7.6)	
		16R068	35 (10.7)	16R044	35 (10.7)	16R056	35 (10.7)	
		16R071	50 (15.2)	16R047	50 (15.2)	16R059	50 (15.2)	
		16R074	(None)	16R050	(None)	16R062	(None)	
	Chop	16R135	25 (7.6)	16R123	25 (7.6)	16R004	25 (7.6)	
		16R138	35 (10.7)	16R114	35 (10.7)	16R126	35 (10.7)	
		16R141	50 (15.2)	16R117	50 (15.2)	16R129	50 (15.2)	
		16R144	(None)	16R120	(None)	16R132	(None)	
External Mix	Gel	16R030	25 (7.6)	16R001	25 (7.6)	16R018	25 (7.6)	
		16R033	35 (10.7)	16R009	35 (10.7)	16R021	35 (10.7)	
		16R036	50 (15.2)	16R012	50 (15.2)	16R024	50 (15.2)	
		16R039	(None)	16R015	(None)	16R027	(None)	
	Chop	16R100	25 (7.6)	16R088	25 (7.6)	16R003	25 (7.6)	
		16R103	35 (10.7)	16R079	35 (10.7)	16R091	35 (10.7)	
		16R106	50 (15.2)	16R082	50 (15.2)	16R094	50 (15.2)	
		16R109	(None)	16R085	(None)	16R097	(None)	
Internal Mix	Gel	16R205	25 (7.6)	16R006	25 (7.6)	16R193	25 (7.6)	
		16R208	35 (10.7)	16R184	35 (10.7)	16R196	35 (10.7)	
		16R211	50 (15.2)	16R187	50 (15.2)	16R199	50 (15.2)	
		16R214	(None)	16R190	(None)	16R202	(None)	
	External Mix	Gel	16R170	25 (7.6)	16R005	25 (7.6)	16R158	25 (7.6)
			16R173	35 (10.7)	16R149	35 (10.7)	16R161	35 (10.7)
			16R176	50 (15.2)	16R152	50 (15.2)	16R164	50 (15.2)
			16R179	(None)	16R155	(None)	16R167	(None)
Internal Mix	Chop	16R300	25 (7.6)	16R301	25 (7.6)	16R302	25 (7.6)	
		16R303	35 (10.7)	16R304	35 (10.7)	16R305	35 (10.7)	
		16R306	50 (15.2)	16R307	50 (15.2)	16R308	50 (15.2)	
		16R309	(None)	16R310	(None)	16R311	(None)	
Internal Mix	Chop	24W435	25 (7.6)	24W432	25 (7.6)	24W438	25 (7.6)	
		24W436	35 (10.7)	24W433	35 (10.7)	24W439	35 (10.7)	
		24W437	50 (15.2)	24W434	50 (15.2)	24W440	50 (15.2)	

17:1 Ratio

Max Air Consumption** - 35 SCFM
Max Fluid Output** - 1gpm
(3.8 lpm)

9:1 Ratio High Output System

Max Air Consumption** - 35 SCFM
Max Fluid Output** - 2.2gpm
(8.4 lpm)''

13:1 Ratio with High Flow Gun 24P435

Max Air Consumption** - 35 SCFM
Max Fluid Output** - 1.5gpm
(5.7 lpm)''

* Systems without hoses do not come with guns

** Fluid and air flow rate for 70 cpm



Graco Spartan products

Closed Molding Systems for RTM + Lite RTM Applications

Products	Spartan	Spartan II Basic	Spartan II Deluxe	Spartan 3 PLC	Spartan 3 PLC with PAC	Spartan 3 PLC with PAC & RFID
Feature	Entry Level Designed specifically for injection	Designed for RTM Lite	Designed for automated RTM Lite	Designed for automated RTM Lite with touch screen programmable	Designed for high volume automated RTM Lite	Designed to simplify high volume production when numerous mold sizes are utilized
Complete recirculation	X	X	X	X	X	X
Pneumatic trigger	X	X	X	X	X	X
Air/Solvent Flush	X	X	X	X	X	X
Low pressure injection	X	X	X	X	X	X
Spartan dispense head	X	X	X	X	X	X
Positive feed SSP catalyst slave pump	X	X	X	X	X	X
Stroke Counter		X	X	X	X	X
Auto-Valve ready		X	X	X	X	X
Low pressure injection with Accu-Pressure		X	X	X	X	X
User Friendly Control panel			X	X	X	X
Dispense timer			X	X	X	X
Adjustable independent solvent flush			X	X	X	X
Independent air flush toggle switch			X	X	X	X
Adjustable Gel-Timer			X	X	X	X
Touch Screen Programmable				X	X	X
30 Programmable injection settings				X	X	X
Programmable digital Gel-Timer				X	X	X
Programmable digital air/solvent flush				X	X	X
Programmable Automatic Catalyst					X	X
Programmable radio frequency identification tags						X
Unlimited programming						X
Password Protected						X
Extended Hose Lengths	Optional	Optional	Optional	Optional	Optional	Optional
Inline heater	Optional	Optional	Optional	Optional	Optional	Optional
Cart, Mast and Boom mounted	Optional	Optional	Optional	Optional	Optional	Optional

Multiple color gel coat system

Graco Multiple Color Gelcoat System

- Ideal for applications that require numerous gel coat colors or continuous change of colors
- Quick, efficient color changes reduce downtime
- The standard two-color system can be expanded with additional colors by adding optional fluid section kits
- Flexible design lets you use one system for both resin and gel coat dispensing

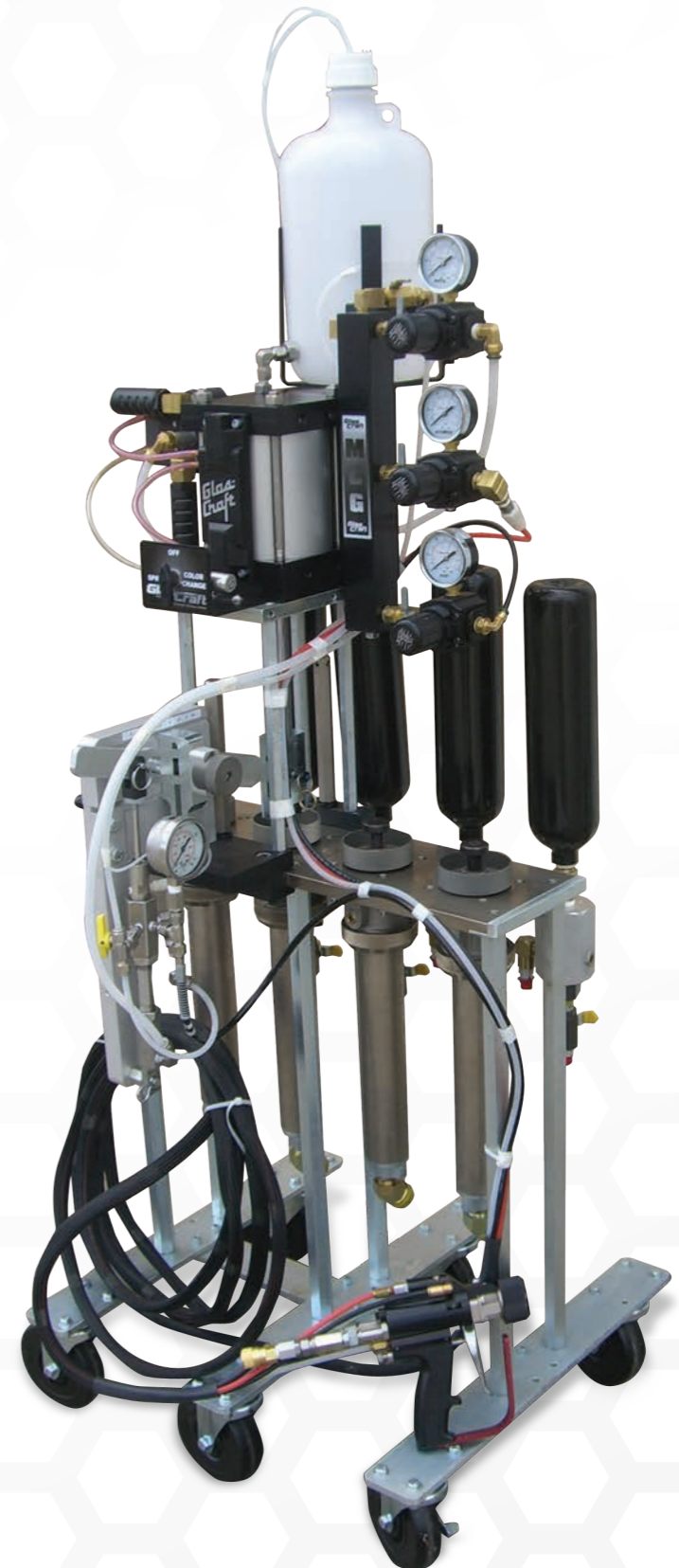

Graco Parts + Accessories



Solvent Flush Kits

- 16M560 Diaphragm Pump Solvent Flush Kit - 2.5 gal (9.5 l)
- 16M561 Diaphragm Pump Solvent Flush Kit - 5 gal (19 l)
- 16M893 Pressure Pot Solvent Flush Kit - 2 gal (7.6 l)
- 16M894 Pressure Pot Solvent Flush Kit - 5 gal (19 l)
- 16M874 CE Pressure Pot Solvent Flush Kit - 2 gal (7.6 l)

Optional Kits

- 16M881 DataTrak Upgrade Kit
- 24M501 5 gal (19 l) Catalyst Tank Kit
- 16M896 55 gal (208 l) Drum Cart for Cart, Mast and Boom
- 16M897 55 gal (208 l) Drum Cart for Pole Cart
- 16M961 Roving Box Kit
- 16N918 Wall Mount Bracket Kit
- 16N761 Boom Kit

Hose Kits

- 16M718 Internal Gel Hose Extension 25 ft (7.6 m)
- 16M587 Internal Gel Hose Bundle 25 ft (7.6 m)
- 16M590 Internal Gel Hose Bundle 35 ft (10.7 m)
- 16M584 Internal Gel Hose Bundle 50 ft (15.2 m)
- 16M719 External Gel Hose Extension 25 ft (7.6 m)
- 16M588 External Gel Hose Bundle 25 ft (7.6 m)
- 16M591 External Gel Hose Bundle 35 ft (10.7 m)
- 16M585 External Gel Hose Bundle 50 ft (15.2 m)
- 16M712 Chop Hose Extension 25 ft (7.6 m)
- 16M586 Chop Hose Bundle 25 ft (7.6 m)
- 16M589 Chop Hose Bundle 35 ft (10.7 m)
- 16M583 Chop Hose Bundle 50 ft (15.2 m)

Replacement Outlet Filters

- 224458 30 mesh, 2-pack
- 238436 30 mesh, 25-pack
- 224459 60 mesh, 2-pack
- 238438 60 mesh, 25-pack
- 224468 100 mesh (standard option), 2-pack
- 238440 100 mesh (standard option), 25-pack
- 224469 200 mesh, 2-pack
- 238442 200 mesh, 25-pack

Pump Kits and Parts

- W17CFS 17:1 Pump Assembly 75 cc SST
- W13DFC 13:1 Pump Assembly 100 cc CS
- W09DFC 9:1 Pump Assembly 150 cc CS
- M07LNL 4.5 in FRP NXT Air Motor
- 16N238 4.5 in FRP NXT Air Motor - Seal Kit
- LW150A 150 cc FRP Lower
- 17E098 150 cc FRP Lower - Seal Kit
- 17E099 150 cc FRP Lower - Connection Kit
- LW100C 100 cc FRP Lower
- 16N232 100 cc FRP Lower - Seal Kit
- 16N243 100 cc FRP Lower - Connection Kit
- LW075S 75 cc FRP Lower
- 16N231 75 cc FRP Lower - Seal Kit
- 16N242 75 cc FRP Lower - Connection Kit
- 16N740 Internal Mix Catalyst Pump Assembly
- 16N741 External Mix Catalyst Pump Assembly
- 16N919 Catalyst Pump Rebuild Kit



FRP Accessories

Heavy Duty Drum Agitator

- Heavy duty gearbox mixes high viscosity materials
- Leak-free and oil-less gearbox prevents material contamination
- Stainless steel agitator and cover for corrosion resistance
- Twin paddles thoroughly mix finishing materials
- Siphon option allows material transfer through agitator shaft
- Access port for easy sampling and inspection of material during operation



Part No.	Description	Drive	HP	Length in (cm)	Material	Manual
231414	Heavy-duty back-gearred agitator with elevator, drum cover and siphon kit	Air	1/2	32 (81.25)	SST	308609
231413	Same as 231414, except without siphon capability	Air	1/2	32 (81.25)	SST	308609
238157	Heavy-duty back-gearred agitator	Air	1/2	32 (81.25)	SST	308609
240209	Same as 238157 with siphon kit	Air	1/2	32 (81.25)	SST	308609
238250	Siphon tube kit; fits 238157 agitator			43 (109)	SST	308609

Fluid Heater Kit

- Variable heating levels for consistent viscosity control
- Approved for hazardous locations
- 7250 psi (500 bar) maximum working pressure
- Stainless steel construction is compatible with polyester resins and coats



Part No.	Description
16N018	Viscon HP Heater Kit – 120V
16N019	Viscon HP Heater Kit – 240V
16N016	Viscon HP Hazardous Location Heater Kit – 120V
16N017	Viscon HP Hazardous Location Heater Kit – 240V
16N119	Heater Mount Kit

Graco has you covered.

Unmatched Quality.

Our focus on continued innovation keeps Graco Fluid Automation at the forefront of fluid handling technology. We typically reinvest three times the industry average into research and development. Our mission is to provide customers with products that result in the **lowest total cost of ownership** while maximizing product quality and business success.

Global Presence.

With facilities located in Europe, Asia Pacific and the United States, Graco provides a personalized, **end-to-end partnership experience**. Our engineers will lead the solution planning, testing and refining of your solution in our regional labs to ultimately overseeing the product installation process.

Global Support.

After installation, **in-person support** will be available from our worldwide distribution network of trained and certified distributors who offer relevant experience, product knowledge and responsive service.

There is no better reassurance than Graco technology, product innovation and the people committed to helping you succeed all day, every day.

Contact us today!

Call **800-746-1334** to speak with a Graco representative, visit **www.graco.com/frp** for more information.



AMERICAS

MINNESOTA

Worldwide Headquarters
Graco Inc.
88-11th Avenue N.E.
Minneapolis, MN 55413

MAILING ADDRESS

P.O. Box 1441
Minneapolis, MN 55440-1441

OHIO

8400 Port Jackson Ave NW,
North Canton, OH 44720

EUROPE

BELGIUM

Graco BVBA
Industrieterrein - Oude Bunders
Slakweidestraat 31
B-3630 Maasmechelen,
Belgium
Tel: 32 89 770 700
Fax: 32 89 770 777

ASIA PACIFIC

AUSTRALIA

Graco Australia Pty Ltd.
Suite 17, 2 Enterprise Drive
Bundoora, Victoria 3083
Australia
Tel: 61 3 9468 8500
Fax: 61 3 9468 8599

CHINA

Graco Hong Kong Ltd.
Shanghai Representative Office
Building 7
1029 Zhongshan Road South,
Huangpu District
Shanghai, 200011
The People's Republic of China
Tel: 86 21 649 50088
Fax: 86 21 649 50077

INDIA

Graco India Pvt Ltd.
Plot No. 295
Udyog Vihar Phase IV
Gurgaon, Haryana, India 122015
Tel: 91 124 6610200
Fax: 91 124 6610201

JAPAN

Graco K.K.
1-27-12 Hayabuchi
Tsuzuki-ku
Yokohama City, Japan 2240025
Tel: 81 45 593 7300
Fax: 81 45 593 7301

KOREA

Graco Korea Inc.
Shinhan Bank Building
4th Floor #1599
Gwanyang-Dong, Dongan-Ku,
Anyang-si, Korea 431-060
Tel: 82 31 476 9400
Fax: 82 31 476 9801



FRP Systems

PROPORTIONERS AND GUNS

FOR GEL COAT AND CHOP APPLICATIONS

©2017 Graco Inc. 349820 Rev.B 9/21 All other brand names or marks are used for identification purposes and are trademarks of their respective owners. All written and visual data contained in this document are based on the latest product information available at the time of publication. Graco reserves the right to make changes at any time without notice.

